

Features

- Generation 4 IGBT technology
- UltraFast: Optimized for high operating frequencies 8-40 kHz in hard switching, >200 kHz in resonant mode
- Very low conduction and switching losses
- HEXFRED™ antiparallel diodes with ultra- soft recovery
- Industry standard package
- UL approved

Benefits

- Increased operating efficiency
- Direct mounting to heatsink
- Performance optimized for power conversion: UPS, SMPS, Welding
- Lower EMI, requires less snubbing

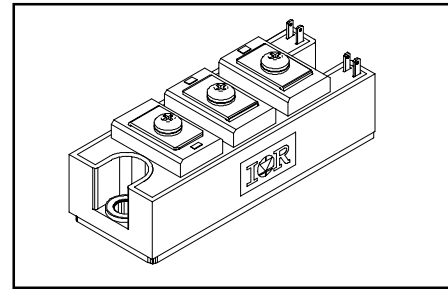
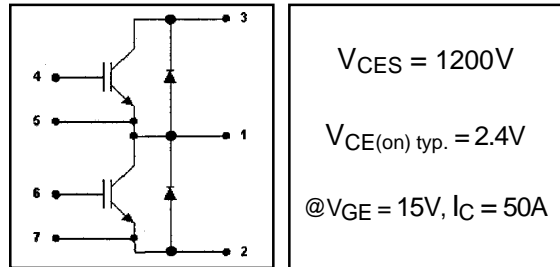

Absolute Maximum Ratings

	Parameter	Max.	Units
V_{CES}	Collector-to-Emitter Voltage	1200	V
$I_C @ T_C = 25^\circ C$	Continuous Collector Current	50	A
I_{CM}	Pulsed Collector Current ①	100	
I_{LM}	Peak Switching Current ②	100	
I_{FM}	Peak Diode Forward Current	100	
V_{GE}	Gate-to-Emitter Voltage	± 20	V
V_{ISOL}	RMS Isolation Voltage, Any Terminal To Case, t = 1 min	2500	W
$P_D @ T_C = 25^\circ C$	Maximum Power Dissipation	280	
$P_D @ T_C = 85^\circ C$	Maximum Power Dissipation	145	
T_J	Operating Junction Temperature Range	-40 to +150	°C
T_{STG}	Storage Temperature Range	-40 to +125	

Thermal / Mechanical Characteristics

	Parameter	Typ.	Max.	Units
$R_{\theta JC}$	Thermal Resistance, Junction-to-Case - IGBT	—	0.44	°C/W
$R_{\theta JC}$	Thermal Resistance, Junction-to-Case - Diode	—	0.70	
$R_{\theta CS}$	Thermal Resistance, Case-to-Sink - Module	0.1	—	N·m
	Mounting Torque, Case-to-Heatsink	—	4.0	
	Mounting Torque, Case-to-Terminal 1, 2 & 3 ③	—	3.0	
	Weight of Module	200	—	g

Electrical Characteristics @ $T_J = 25^\circ\text{C}$ (unless otherwise specified)

	Parameter	Min.	Typ.	Max.	Units	Conditions
$V_{(BR)CES}$	Collector-to-Emitter Breakdown Voltage	1200	—	—	V	$V_{GE} = 0V, I_C = 1mA$
$V_{CE(on)}$	Collector-to-Emitter Voltage	—	2.4	3.0		$V_{GE} = 15V, I_C = 50A$
		—	2.2	—		$V_{GE} = 15V, I_C = 50A, T_J = 125^\circ\text{C}$
$V_{GE(th)}$	Gate Threshold Voltage	3.0	—	6.0		$V_{CE} = 6.0V, I_C = 500\mu A$
$\Delta V_{GE(th)}/\Delta T_J$	Temperature Coeff. of Threshold Voltage	—	-11	—	mV/ $^\circ\text{C}$	$V_{CE} = 6.0V, I_C = 500\mu A$
g_{fe}	Forward Transconductance ④	—	72	—	S	$V_{CE} = 25V, I_C = 1200V$
I_{CES}	Collector-to-Emitter Leaking Current	—	—	1.0	mA	$V_{GE} = 0V, V_{CE} = 50A$
		—	—	10		$V_{GE} = 0V, V_{CE} = 1200V, T_J = 125^\circ\text{C}$
V_{FM}	Diode Forward Voltage - Maximum	—	2.9	4.1	V	$I_F = 50A, V_{GE} = 0V$
		—	2.7	—		$I_F = 50A, V_{GE} = 0V, T_J = 125^\circ\text{C}$
I_{GES}	Gate-to-Emitter Leakage Current	—	—	250	nA	$V_{GE} = \pm 20V$

Dynamic Characteristics - $T_J = 125^\circ\text{C}$ (unless otherwise specified)

	Parameter	Min.	Typ.	Max.	Units	Conditions
Q_g	Total Gate Charge (turn-on)	—	397	596	nC	$V_{CC} = 400V$
Q_{ge}	Gate - Emitter Charge (turn-on)	—	67	100		$I_C = 60A$
Q_{gc}	Gate - Collector Charge (turn-on)	—	132	197		$T_J = 25^\circ\text{C}$
$t_{d(on)}$	Turn-On Delay Time	—	74	—	ns	$R_{G1} = 15\Omega, R_{G2} = 0\Omega,$
t_r	Rise Time	—	82	—		$I_C = 50A$
$t_{d(off)}$	Turn-Off Delay Time	—	313	—		$V_{CC} = 720V$
t_f	Fall Time	—	327	—		$V_{GE} = \pm 15V$
E_{on}	Turn-On Switching Energy	—	6.0	—	mJ	Inductor load
$E_{off(1)}$	Turn-Off Switching Energy	—	10	—		
$E_{ts(1)}$	Total Switching Energy	—	16	24		
C_{ies}	Input Capacitance	—	8933	—	pF	$V_{GE} = 0V$
C_{oes}	Output Capacitance	—	397	—		$V_{CC} = 30V$
C_{res}	Reverse Transfer Capacitance	—	77	—		$f = 1\text{ MHz}$
t_{rr}	Diode Reverse Recovery Time	—	141	—	ns	$I_C = 50A$
I_{rr}	Diode Peak Reverse Current	—	66	—	A	$R_{G1} = 15\Omega$
Q_{rr}	Diode Recovery Charge	—	4616	—	nC	$R_{G2} = 0\Omega$
$di_{(rec)M}/dt$	Diode Peak Rate of Fall of Recovery During t_b	—	999	—	A/ μs	$V_{CC} = 720V$ $di/dt = 1200A/\mu\text{s}$

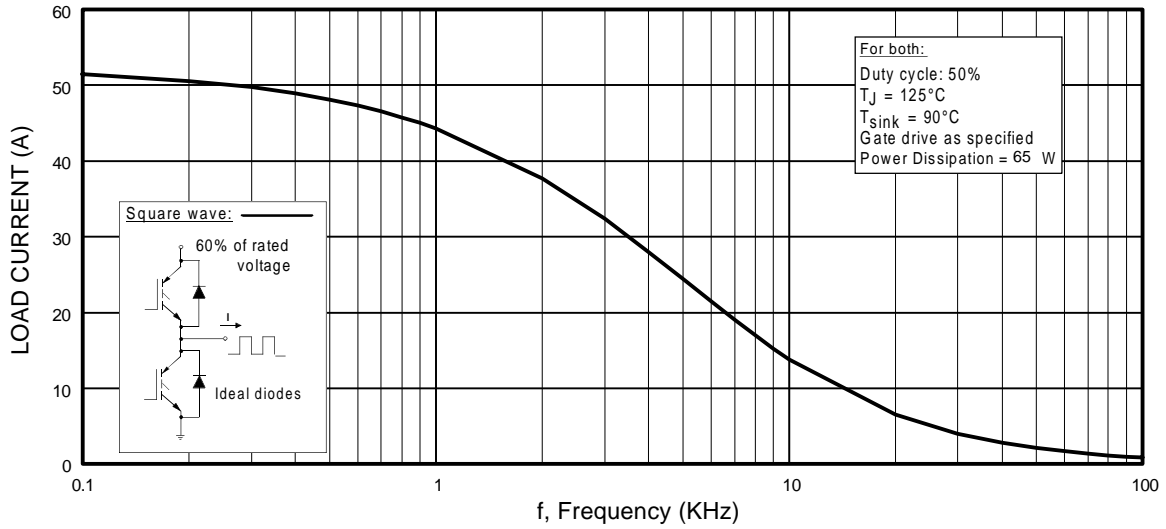

Fig. 1 - Typical Load Current vs. Frequency
 (Load Current = I_{RMS} of fundamental)

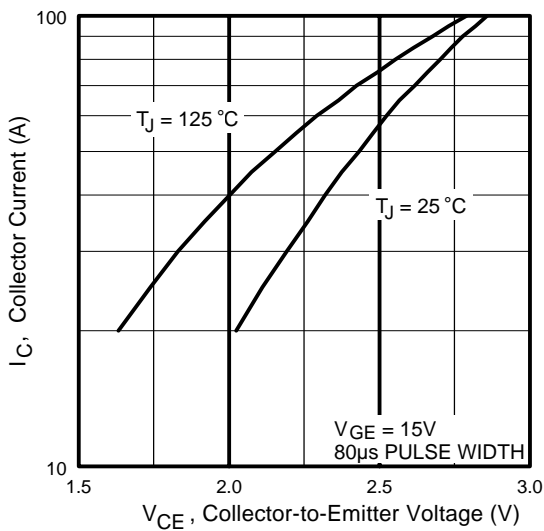

Fig. 2 - Typical Output Characteristics

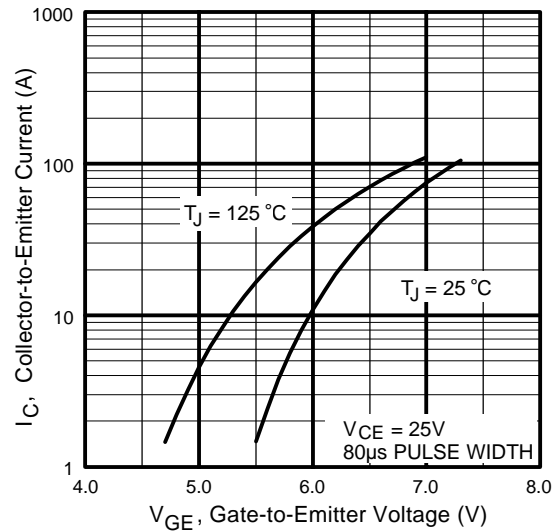

Fig. 3 - Typical Transfer Characteristics

GA50TS120U

International
IRF Rectifier

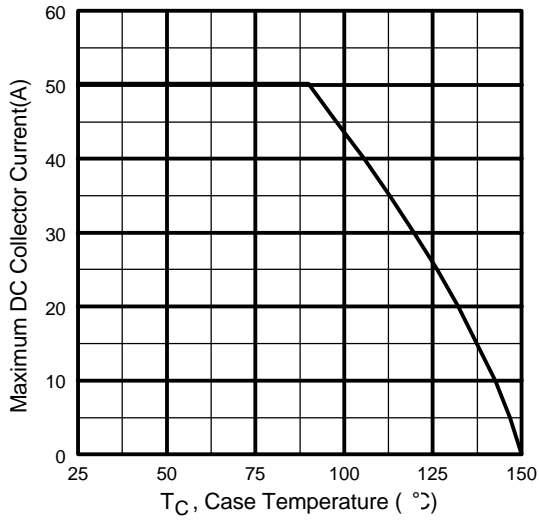

Fig. 4 - Maximum Collector Current vs. Case Temperature

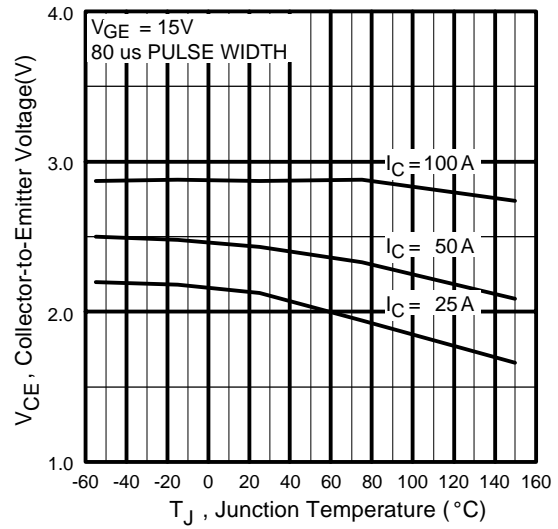

Fig. 5 - Typical Collector-to-Emitter Voltage vs. Junction Temperature

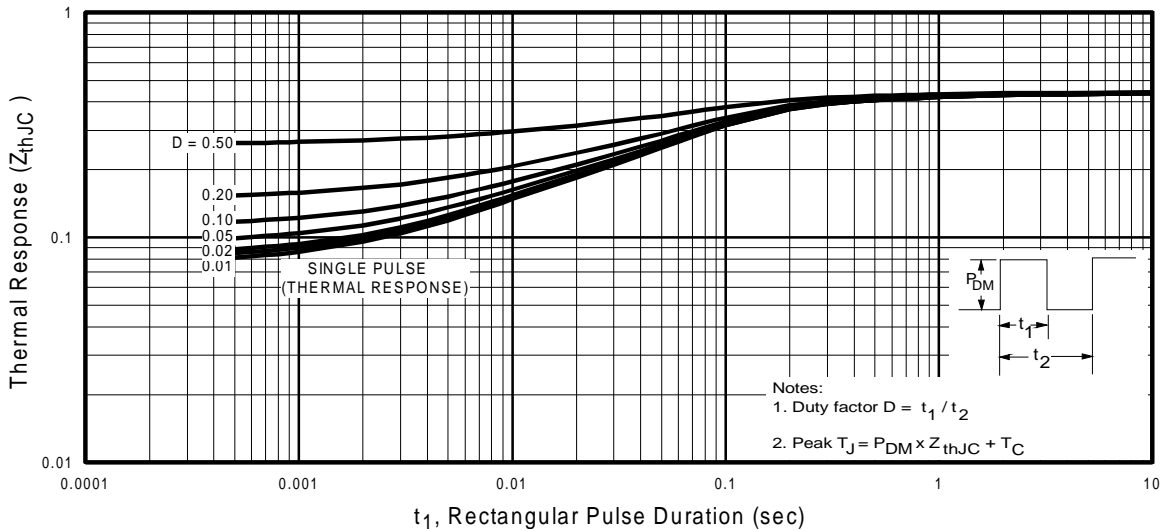

Fig. 6 - Maximum Effective Transient Thermal Impedance, Junction-to-Case

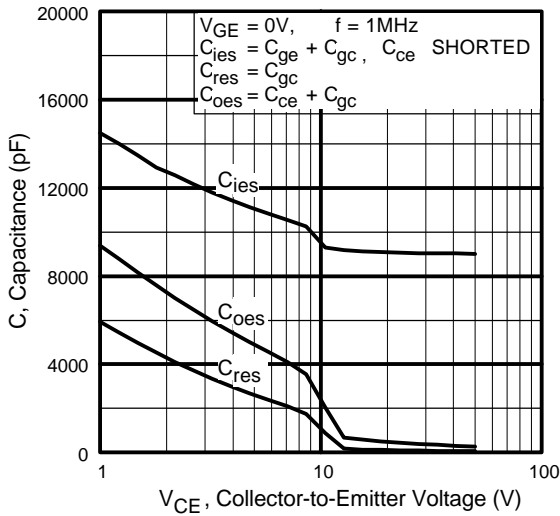

Fig. 7 - Typical Capacitance vs. Collector-to-Emitter Voltage

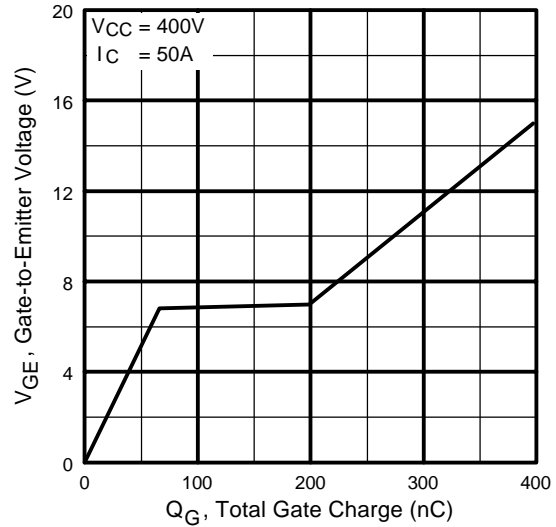

Fig. 8 - Typical Gate Charge vs. Gate-to-Emitter Voltage

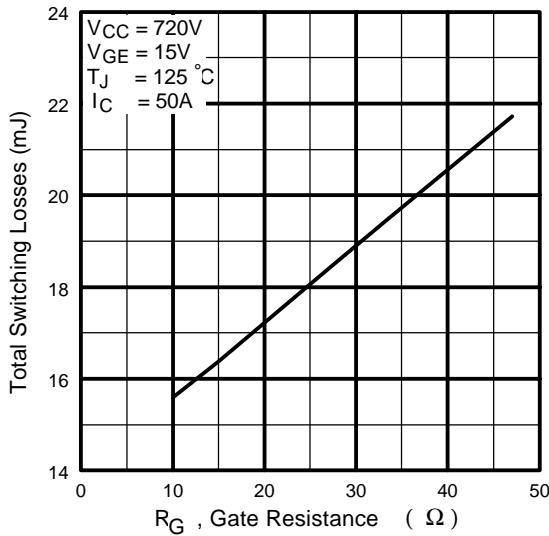

Fig. 9 - Typical Switching Losses vs. Gate Resistance

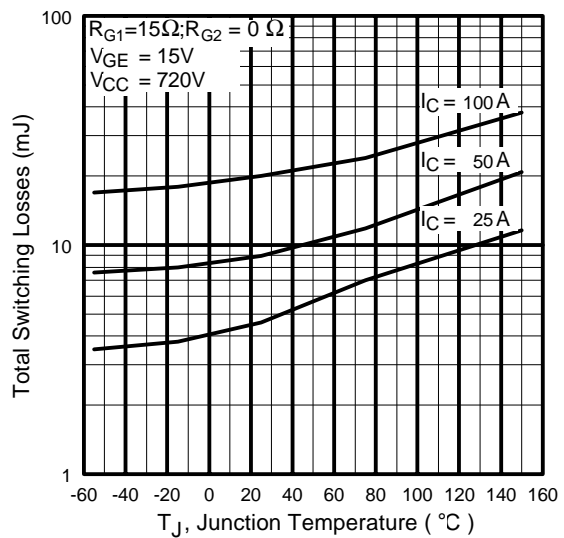

Fig. 10 - Typical Switching Losses vs. Junction Temperature

GA50TS120U

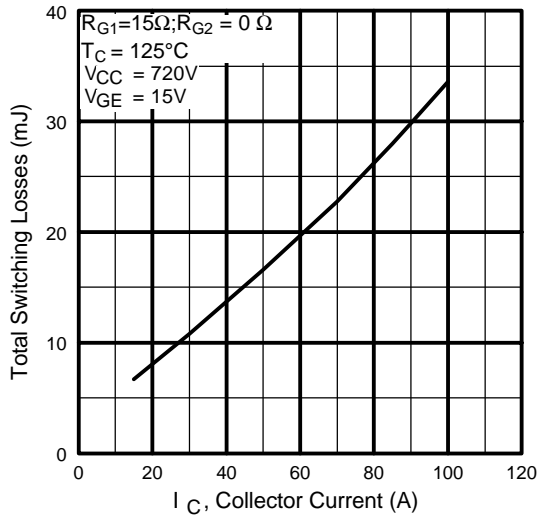

Fig. 11 - Typical Switching Losses vs. Collector-to-Emitter Current

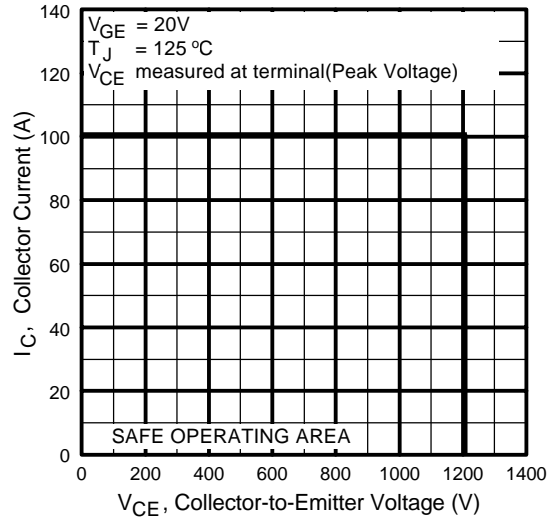

Fig. 12 - Reverse Bias SOA

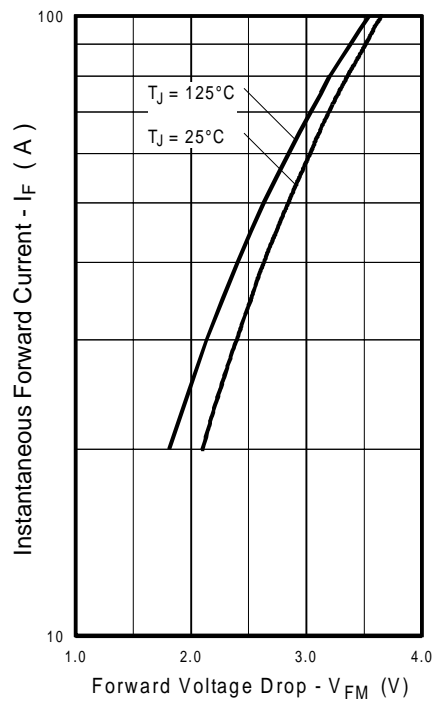

Fig. 13 - Typical Forward Voltage Drop vs. Instantaneous Forward Current

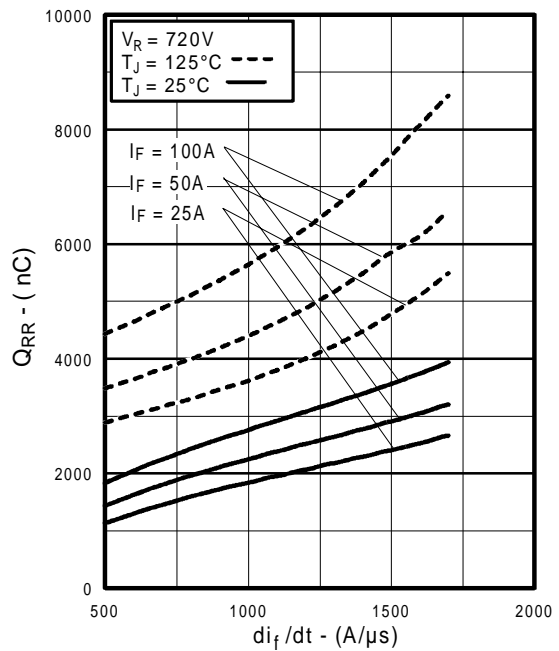

Fig. 14 - Typical Stored Charge vs. di_f/dt

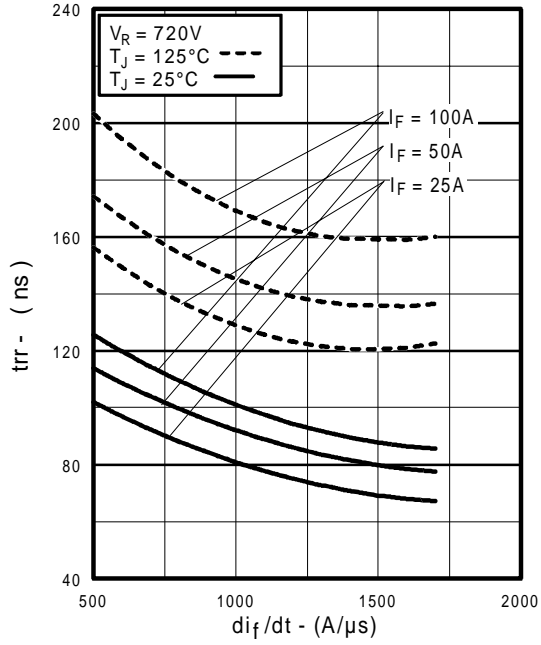

Fig. 15 - Typical Reverse Recovery vs. di_f/dt

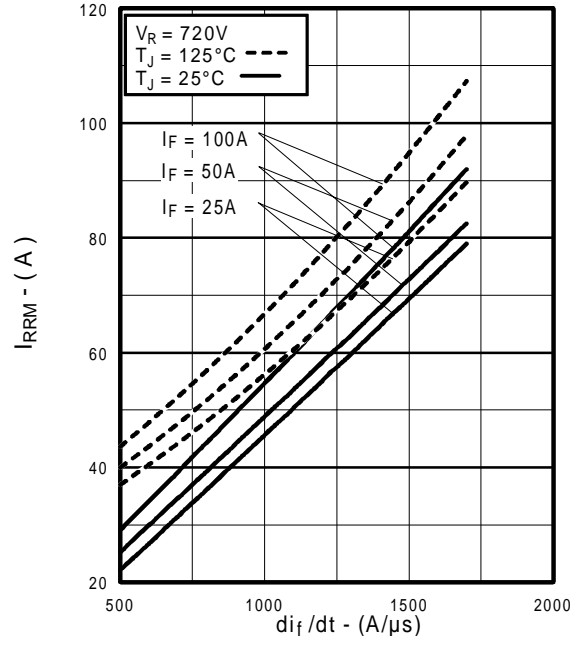

Fig. 16 - Typical Recovery Current vs. di_f/dt

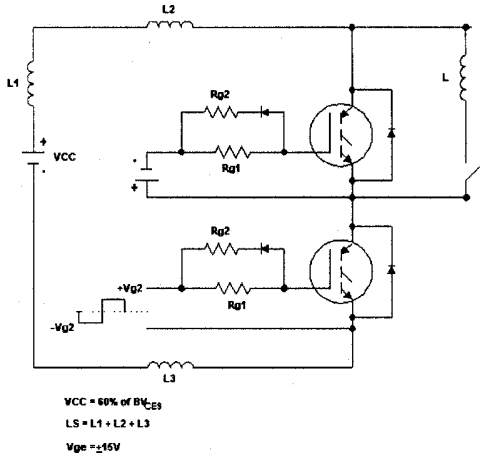

Fig. 17a - Test Circuit for Measurement of I_{LM} , E_{on} , $E_{off}(\text{diode})$, t_{rr} , Q_{rr} , I_{rr} , $t_{d(on)}$, t_r , $t_{d(off)}$, t_f

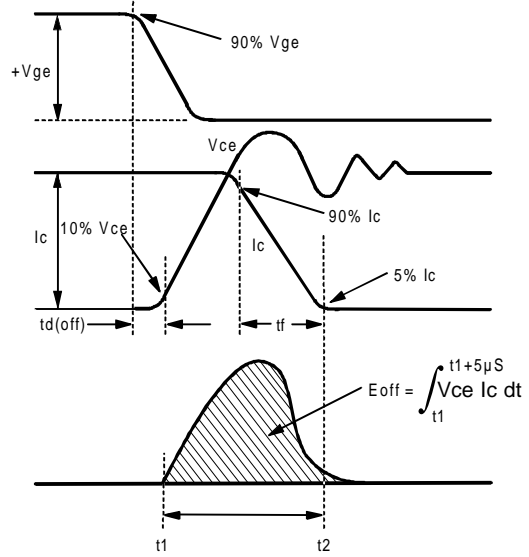

Fig. 17b - Test Waveforms for Circuit of Fig. 18a, Defining E_{off} , $t_{d(off)}$, t_f

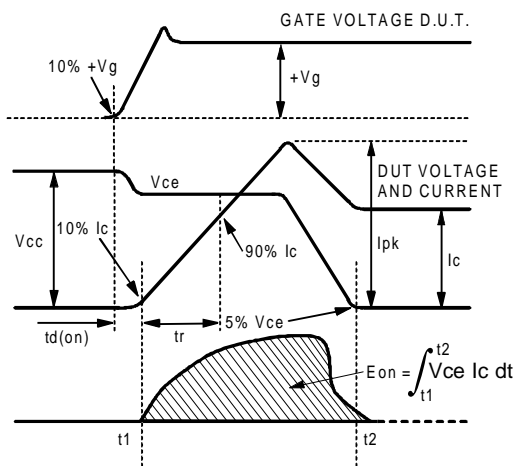

Fig. 17c - Test Waveforms for Circuit of Fig. 18a, Defining E_{on} , $t_{d(on)}$, t_r

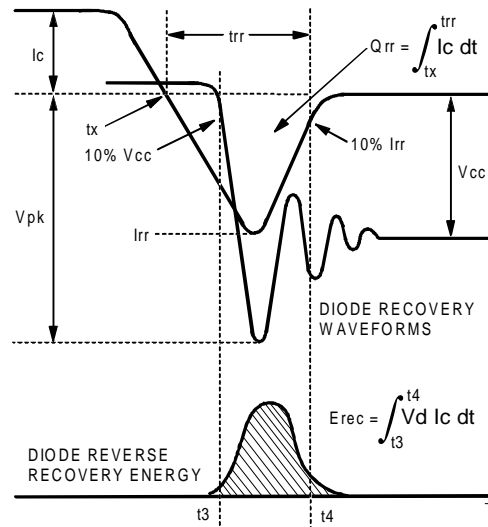

Fig. 17d - Test Waveforms for Circuit of Fig. 18a, Defining E_{rec} , t_{rr} , Q_{rr} , I_{rr}

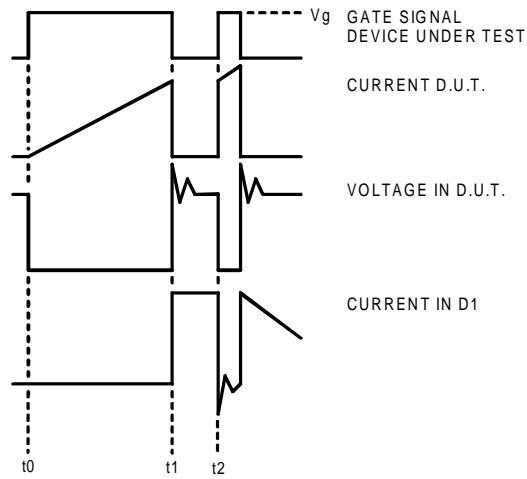

Figure 17e. Macro Waveforms for Figure 18a's Test Circuit

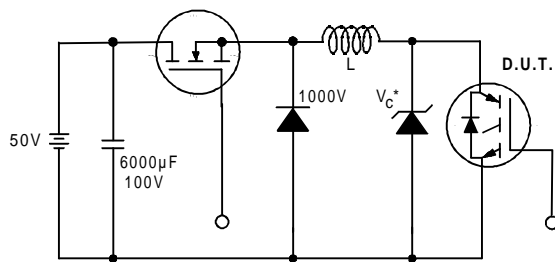

Figure 18. Clamped Inductive Load Test Circuit

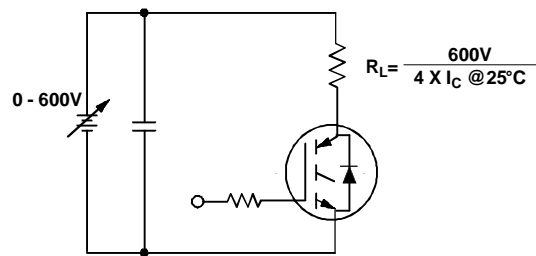

Figure 19. Pulsed Collector Current Test Circuit

GA50TS120U

International
IR Rectifier

Notes:

- ① Repetitive rating; $V_{GE} = 20V$, pulse width limited by max. junction temperature.
- ② See fig. 17
- ③ For screws M5x0.8
- ④ Pulse width 50 μ s; single shot.

Case Outline — INT-A-PAK

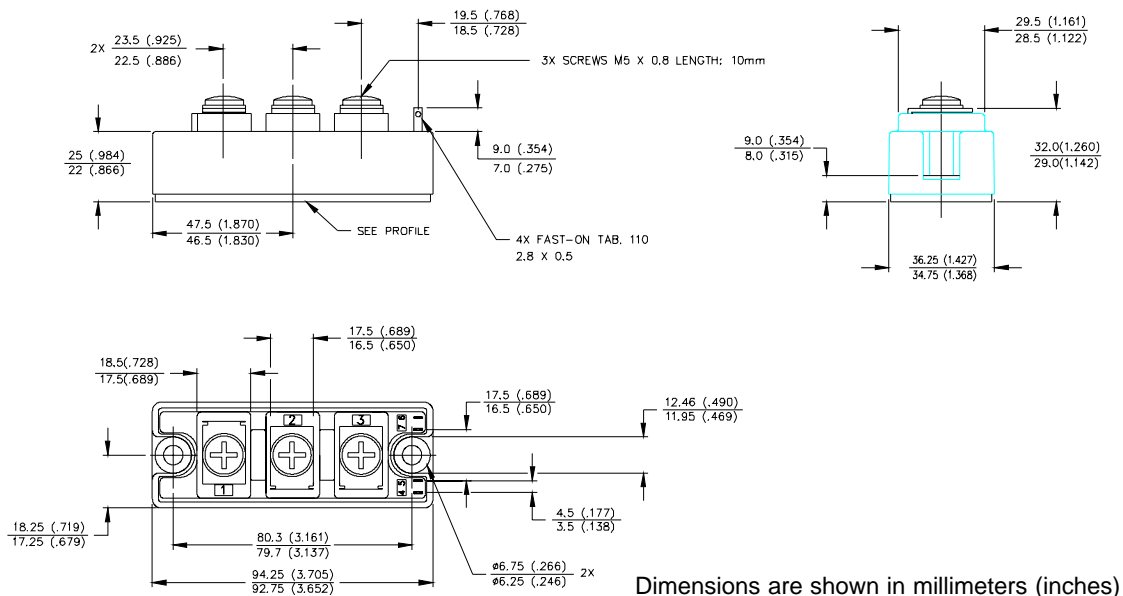

International
IR Rectifier

IR WORLD HEADQUARTERS: 233 Kansas St., El Segundo, California 90245, USA Tel: (310) 252-7105
IR EUROPEAN REGIONAL CENTRE: 439/445 Godstone Rd, Whyteleafe, Surrey CR3 OBL, UK Tel: ++ 44 (0)20 8645 8000
IR CANADA: 15 Lincoln Court, Brampton, Ontario L6T3Z2, Tel: (905) 453 2200
IR GERMANY: Saalburgstrasse 157, 61350 Bad Homburg Tel: ++ 49 (0) 6172 96590
IR ITALY: Via Liguria 49, 10071 Borgaro, Torino Tel: ++ 39 011 451 0111
IR JAPAN: K&H Bldg., 2F, 30-4 Nishi-Ikebukuro 3-Chome, Toshima-Ku, Tokyo 171 Tel: 81 (0)3 3983 0086
IR SOUTHEAST ASIA: 1 Kim Seng Promenade, Great World City West Tower, 13-11, Singapore 237994 Tel: ++ 65 (0)838 4630
IR TAIWAN: 16 Fl. Suite D. 207, Sec. 2, Tun Haw South Road, Taipei, 10673 Tel: 886-(0)2 2377 9936

Data and specifications subject to change without notice. 10/00