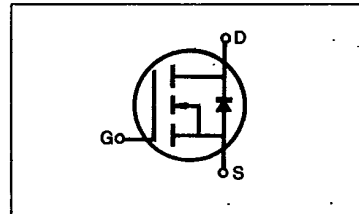
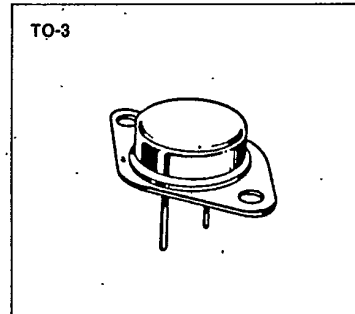

**IRF420/421/422/423****N-CHANNEL  
POWER MOSFETS****FEATURES**

- Low  $R_{DS(on)}$  at high voltage
- Improved inductive ruggedness
- Excellent high voltage stability
- Fast switching times
- Rugged polysilicon gate cell structure
- Low input capacitance
- Extended safe operating area
- Improved high temperature reliability
- TO-3 package (High voltage)

**PRODUCT SUMMARY**

Part Number	$V_{DS}$	$R_{DS(on)}$	$I_D$
IRF420	500V	3.0 $\Omega$	2.5A
IRF421	450V	3.0 $\Omega$	2.5A
IRF422	500V	4.0 $\Omega$	2.0A
IRF423	450V	4.0 $\Omega$	2.0A

**MAXIMUM RATINGS**

Characteristic	Symbol	IRF420	IRF421	IRF422	IRF423	Unit
Drain-Source Voltage (1)	$V_{DS}$	500	450	500	450	Vdc
Drain-Gate Voltage ( $R_{GS}=1.0M\Omega$ ) (1)	$V_{DGR}$	500	450	500	450	Vdc
Gate-Source Voltage	$V_{GS}$	$\pm 20$				Vdc
Continuous Drain Current $T_C=25^\circ C$	$I_D$	2.5	2.5	2.0	2.0	Adc
Continuous Drain Current $T_C=100^\circ C$	$I_D$	1.5	1.5	1.0	1.0	Adc
Drain Current—Pulsed (3)	$I_{DM}$	10	10	8.0	8.0	Adc
Gate Current—Pulsed	$I_{GM}$	$\pm 1.5$				Adc
Total Power Dissipation @ $T_C=25^\circ C$ Derate above $25^\circ C$	$P_D$	40 0.32				Watts W/ $^\circ C$
Operating and Storage Junction Temperature Range	$T_J, T_{stg}$	-55 to 150				$^\circ C$
Maximum Lead Temp. for Soldering Purposes, 1/8" from case for 5 seconds	$T_L$	300				$^\circ C$

Notes: (1)  $T_J=25^\circ C$  to  $150^\circ C$

(2) Pulse test: Pulse width  $\leq 300\mu s$ , Duty Cycle  $\leq 2\%$

(3) Repetitive rating: Pulse width limited by max. junction temperature

**IRF420/421/422/423****N-CHANNEL  
POWER MOSFETS****ELECTRICAL CHARACTERISTICS** ( $T_C=25^\circ\text{C}$  unless otherwise specified)

Characteristic	Symbol	Type	Min	Typ	Max	Units	Test Conditions
Drain-Source Breakdown Voltage	$BV_{DSS}$	IRF420 IRF422	500	—	—	V	$V_{GS}=0V$
		IRF421 IRF423	450	—	—	V	$I_D=250\mu A$
Gate Threshold Voltage	$V_{GS(th)}$	ALL	2.0	—	4.0	V	$V_{DS}=V_{GS}$ , $I_D=250\mu A$
Gate-Source Leakage Forward	$I_{GSS}$	ALL	—	—	100	nA	$V_{GS}=20V$
Gate-Source Leakage Reverse	$I_{GSS}$	ALL	—	—	-100	nA	$V_{GS}=-20V$
Zero Gate Voltage Drain Current	$I_{DSS}$	ALL	—	—	250	$\mu A$	$V_{DS}=\text{Max. Rating}$ , $V_{GS}=0V$
			—	—	1000	$\mu A$	$V_{DS}=\text{Max. Rating}\times 0.8$ , $V_{GS}=0V$ , $T_C=125^\circ\text{C}$
On-State Drain-Source Current (2)	$I_{D(on)}$	IRF420 IRF421	2.5	—	—	A	$V_{DS}>I_{D(on)}\times R_{DS(on) \text{ max.}}$ , $V_{GS}=10V$
		IRF422 IRF423	2.0	—	—	A	
Static Drain-Source On-State Resistance (2)	$R_{DS(on)}$	IRF420 IRF421	—	2.5	3.0	$\Omega$	$V_{GS}=10V$ , $I_D=1.0A$
		IRF422 IRF423	—	3.0	4.0	$\Omega$	
Forward Transconductance (2)	$g_{fs}$	ALL	1.0	1.75	—	$\Omega$	$V_{DS}>I_{D(on)}\times R_{DS(on) \text{ max.}}$ , $I_D=1.0A$
Input Capacitance	$C_{iss}$	ALL	—	300	600	pF	$V_{GS}=0V$ , $V_{DS}=25V$ , $f=1.0\text{MHz}$
Output Capacitance	$C_{oss}$	ALL	—	75	150	pF	
Reverse Transfer Capacitance	$C_{rfs}$	ALL	—	20	40	pF	
Turn-On Delay Time	$t_{d(on)}$	ALL	—	—	60	ns	$V_{DD}=0.5BV_{DSS}$ , $I_D=1.0A$ , $Z_O=50\Omega$ , (MOSFET switching times are essentially independent of operating temperature.)
Rise Time	$t_r$	ALL	—	—	50	ns	
Turn-Off Delay Time	$t_{d(off)}$	ALL	—	—	60	ns	
Fall Time	$t_f$	ALL	—	—	30	ns	
Total Gate Charge (Gate-Source Plus Gate-Drain)	$Q_g$	ALL	—	11	15	nC	$V_{GS}=10V$ , $I_D=3.0A$ , $V_{DS}=0.8 \text{ Max. Rating}$ (Gate charge is essentially independent of operating temperature.)
Gate-Source Charge	$Q_{gs}$	ALL	—	5.0	—	nC	
Gate-Drain ("Miller") Charge	$Q_{gd}$	ALL	—	6.0	—	nC	

**THERMAL RESISTANCE**

Junction-to-Case	$R_{thJC}$	ALL	—	—	3.12	K/W	
Case-to-Sink	$R_{thCS}$	ALL	—	0.1	—	K/W	Mounting surface flat, smooth, and greased
Junction-to-Ambient	$R_{thJA}$	ALL	—	—	30	K/W	Free Air Operation

Notes: (1)  $T_J=25^\circ\text{C}$  to  $150^\circ\text{C}$ (2) Pulse test: Pulse width  $\leq 300\mu s$ , Duty Cycle  $\leq 2\%$ 

(3) Repetitive rating: Pulse width limited by max. junction temperature



98 DE 7964142 0005131 7  
**IRF420/421/422/423**

**N-CHANNEL  
 POWER MOSFETS**

**SOURCE-DRAIN DIODE RATINGS AND CHARACTERISTICS**

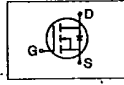
Characteristic	Symbol	Type	Min	Typ	Max	Units	Test Conditions
Continuous Source Current (Body Diode)	I <sub>S</sub>	IRF420	—	—	2.5	A	Modified MOSFET symbol showing the integral reverse P-N junction rectifier. 
		IRF421	—	—	2.0	A	
		IRF422	—	—	2.0	A	
		IRF423	—	—	2.0	A	
Pulse Source Current (Body Diode) (3)	I <sub>SM</sub>	IRF420	—	—	10	A	
		IRF421	—	—	10	A	
		IRF422	—	—	8.0	A	
		IRF423	—	—	8.0	A	
Diode Forward Voltage (2)	V <sub>SD</sub>	IRF420	—	—	1.4	V	T <sub>C</sub> =25°C, I <sub>S</sub> =2.5A, V <sub>GS</sub> =0V
		IRF421	—	—	1.4	V	T <sub>C</sub> =25°C, I <sub>S</sub> =2.0A, V <sub>GS</sub> =0V
		IRF422	—	—	1.3	V	T <sub>C</sub> =25°C, I <sub>S</sub> =2.0A, V <sub>GS</sub> =0V
Reverse Recovery Time	t <sub>rr</sub>	ALL	—	600	—	ns	T <sub>J</sub> =150°C, I <sub>F</sub> =2.5A, di/dt=100A/μs

Notes: (1) T<sub>J</sub>=25°C to 150°C (2) Pulse test: Pulse width ≤ 300μs, Duty Cycle ≤ 2%  
 (3) Repetitive rating: Pulse width limited by max. junction temperature

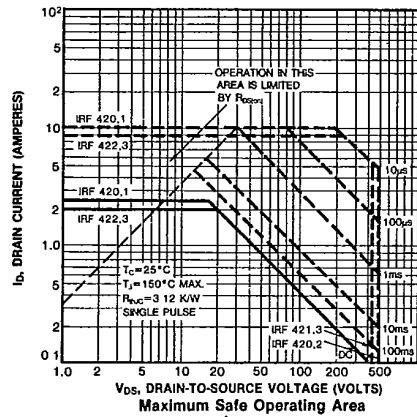
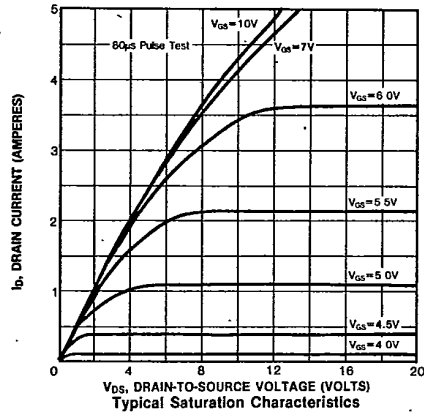
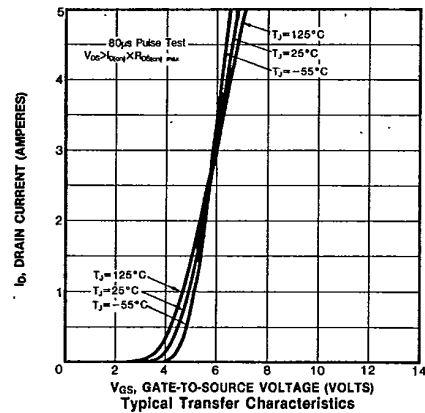
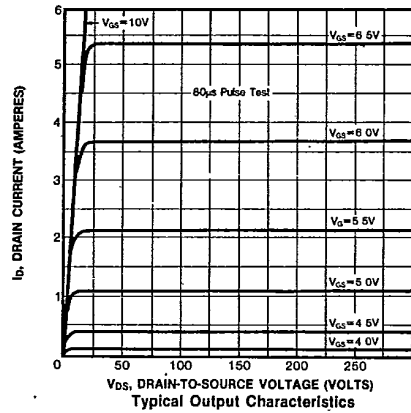

IRF420/421/422/423

N-CHANNEL  
POWER MOSFETS

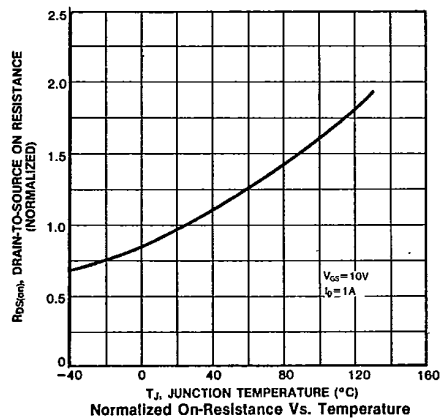
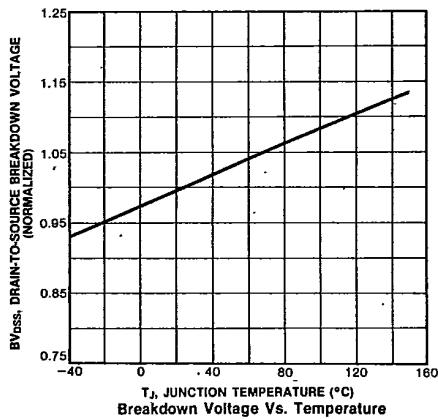
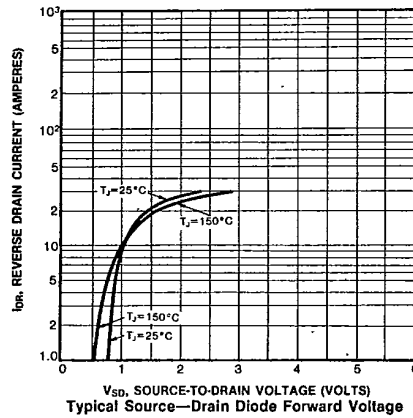
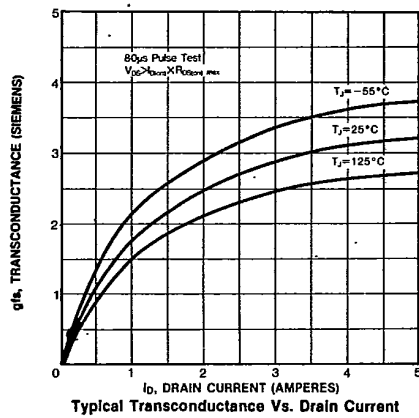
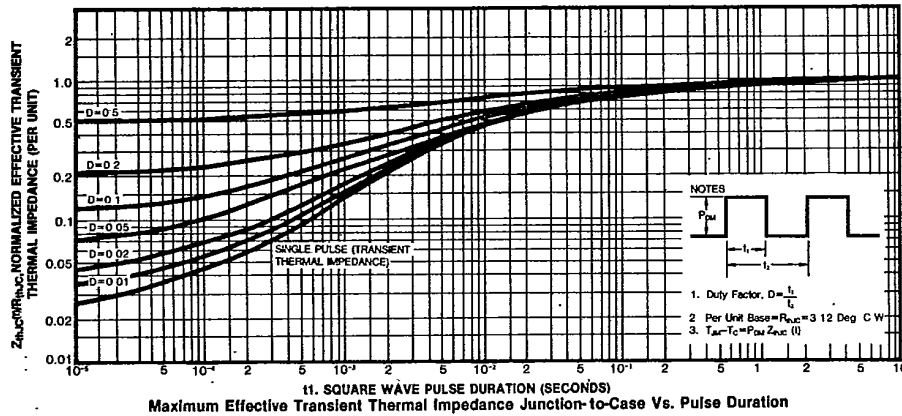

IRF420/421/422/423

N-CHANNEL  
POWER MOSFETS

