

**HIGH FREQUENCY AMPLIFIER AND SWITCHING**  
**NPN SILICON EPITAXIAL TRANSISTOR**  
**MINI MOLD**

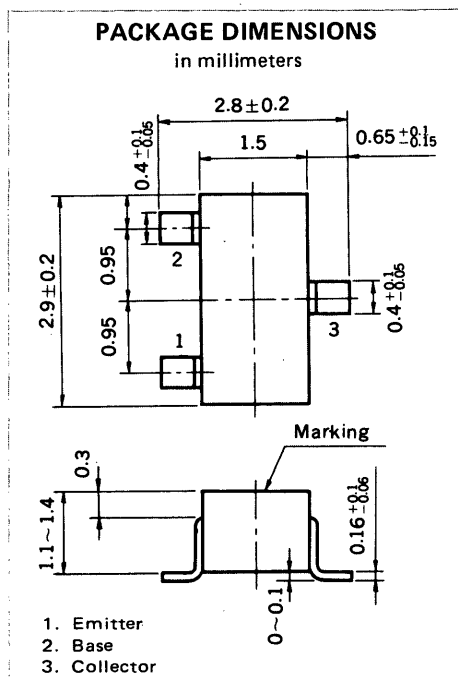

**FEATURES**

- High Gain Bandwidth Product:  $f_T = 200$  MHz MIN.
- Complementary to 2SA1464

**ABSOLUTE MAXIMUM RATINGS**

Maximum Voltages and Current ( $T_a = 25^\circ\text{C}$ )

Collector to Base Voltage	$V_{CBO}$	60	V
Collector to Emitter Voltage	$V_{CEO}$	40	V
Emitter to Base Voltage	$V_{EBO}$	5.0	V
Collector Current (DC)	$I_C$	500	mA

Maximum Power Dissipation

Total Power Dissipation at $25^\circ\text{C}$ Ambient Temperature	$P_T$	200	mW
--	-------	-----	----

Maximum Temperatures

Junction Temperature	$T_j$	150	$^\circ\text{C}$
Storage Temperature Range	$T_{stg}$	-55 to +150	$^\circ\text{C}$

**ELECTRICAL CHARACTERISTICS ( $T_a = 25^\circ\text{C}$ )**

CHARACTERISTIC	SYMBOL	MIN.	TYP.	MAX.	UNIT	TEST CONDITIONS
Collector Cutoff Current	$I_{CBO}$			100	nA	$V_{CB} = 40\text{ V}, I_E = 0$
Emitter Cutoff Current	$I_{EBO}$			100	nA	$V_{EB} = 4.0\text{ V}, I_C = 0$
DC Current Gain	$h_{FE1}$	75	150	300		$V_{CE} = 1.0\text{ V}, I_C = 150\text{ mA}$
DC Current Gain	$h_{FE2}$	20	75			$V_{CE} = 2.0\text{ V}, I_C = 500\text{ mA}$
Collector Saturation Voltage	$V_{CE(sat)}$		0.25	0.75	V	$I_C = 500\text{ mA}, I_B = 50\text{ mA}$
Base Saturation Voltage	$V_{BE(sat)}$		1.0	1.2	V	$I_C = 500\text{ mA}, I_B = 50\text{ mA}$
Gain Bandwidth Product	$f_T$	200	400		MHz	$V_{CE} = 10\text{ V}, I_E = -20\text{ mA}$
Output Capacitance	$C_{ob}$		3.5	8.0	pF	$V_{CB} = 10\text{ V}, I_E = 0, f = 1.0\text{ MHz}$
Turn-on Time	$t_{on}$			35	ns	$V_{CC} = 30\text{ V}$
Storage Time	$t_{stg}$			225	ns	$I_C = 150\text{ mA}$
Turn-off Time	$t_{off}$			275	ns	$I_{B1} = -I_{B2} = 15\text{ mA}$

\* Pulsed:  $PW \leq 350\ \mu\text{s}$ , Duty Cycle  $\leq 2\%$

**$h_{FE}$  Classification**

Marking	B12	B13	B14
$h_{FE1}$	75 to 150	100 to 200	150 to 300

SWITCHING TIME TEST CIRCUIT

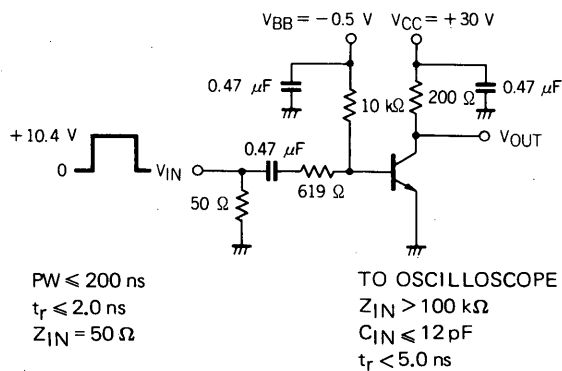

PW ≤ 200 ns  
 $t_r \leq 2.0$  ns  
 $Z_{IN} = 50 \Omega$

TO OSCILLOSCOPE  
 $Z_{IN} > 100 \text{ k}\Omega$   
 $C_{IN} \leq 12 \text{ pF}$   
 $t_r < 5.0$  ns

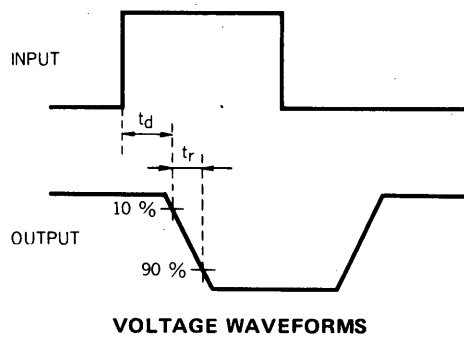

$t_{on}$  SWITCHING

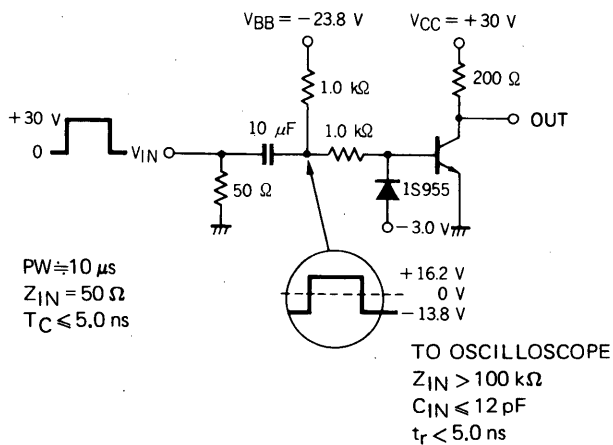

PW ≈ 10 μs  
 $Z_{IN} = 50 \Omega$   
 $T_C \leq 5.0$  ns

TO OSCILLOSCOPE  
 $Z_{IN} > 100 \text{ k}\Omega$   
 $C_{IN} \leq 12 \text{ pF}$   
 $t_r < 5.0$  ns

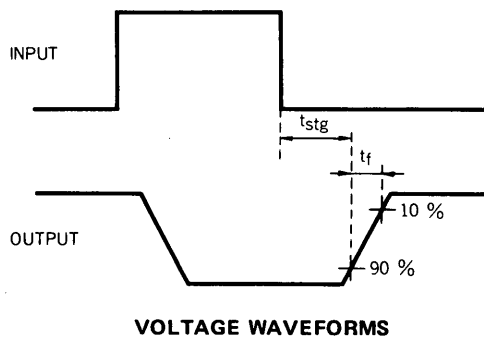

$t_{off}$  SWITCHING

TYPICAL CHARACTERISTICS ( $T_a = 25^\circ\text{C}$ )

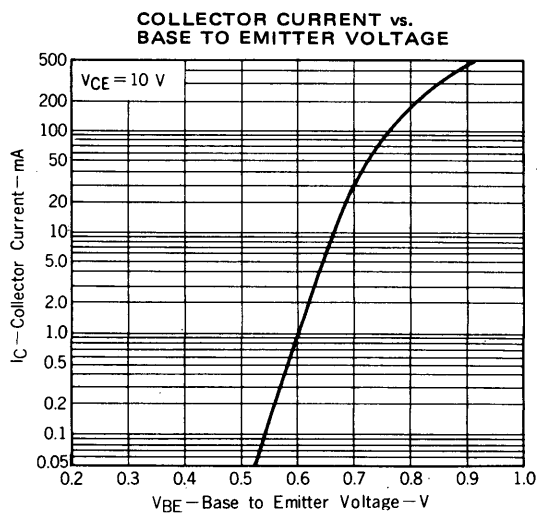
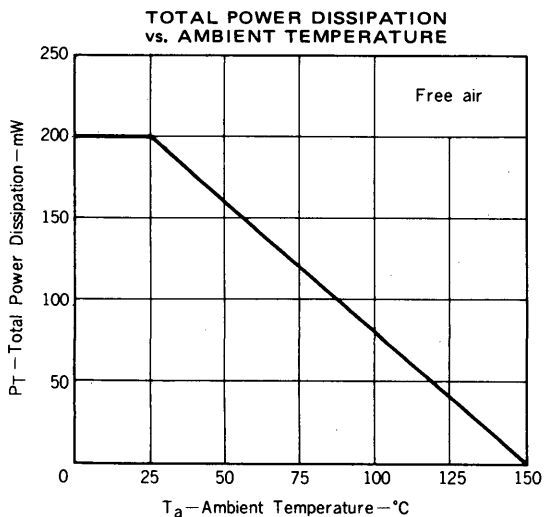

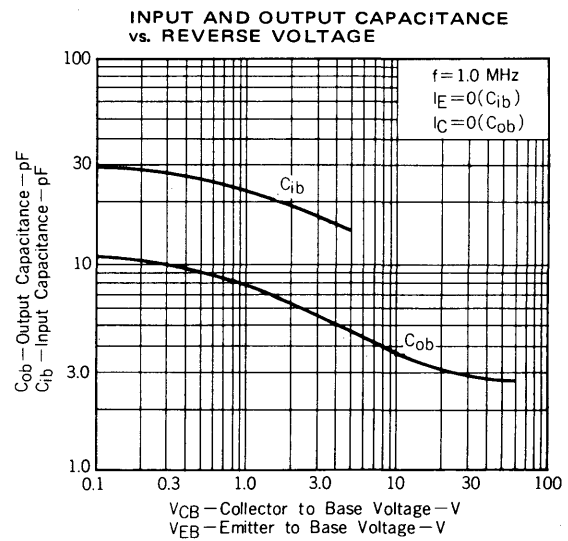
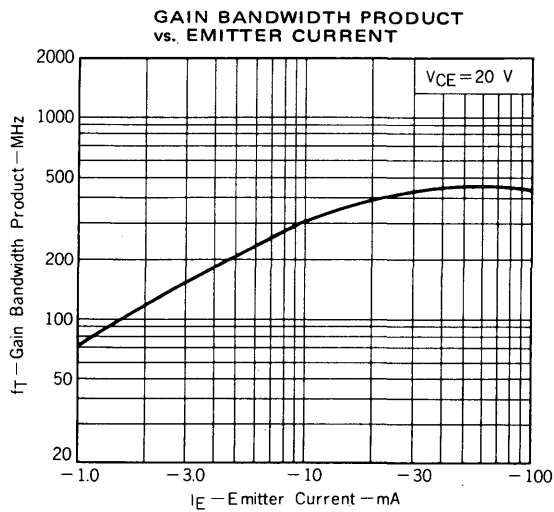
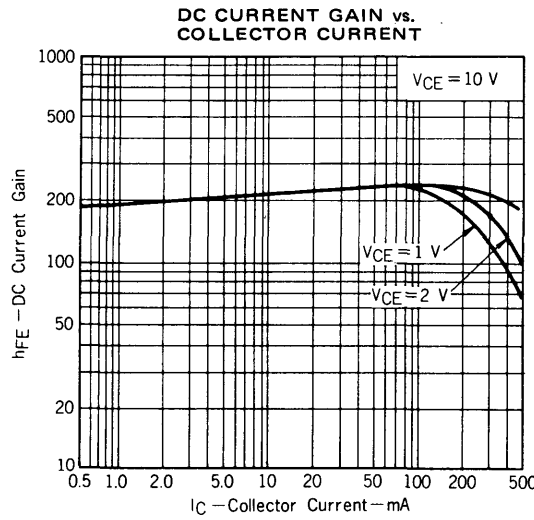
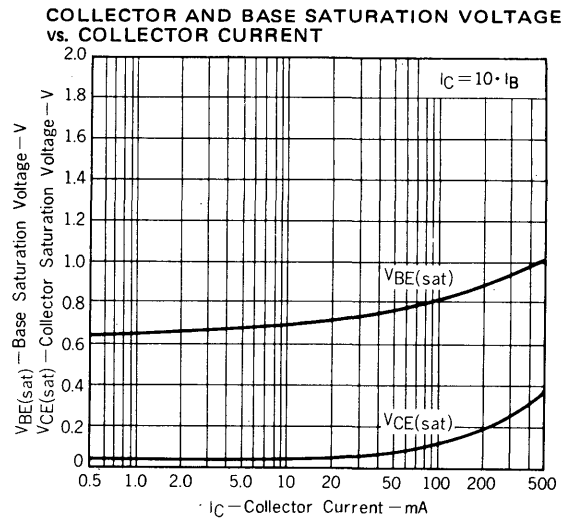
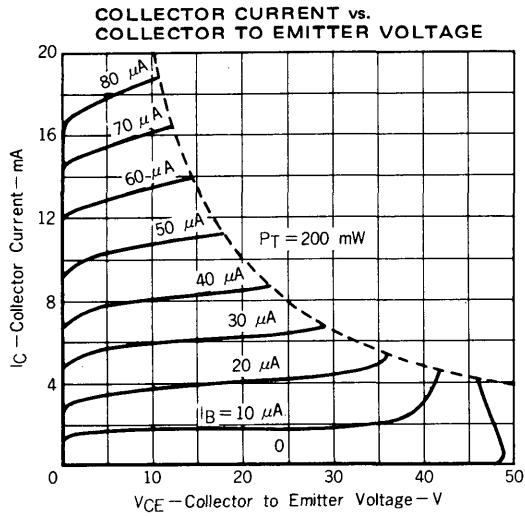

DELAY TIME vs. COLLECTOR CURRENT

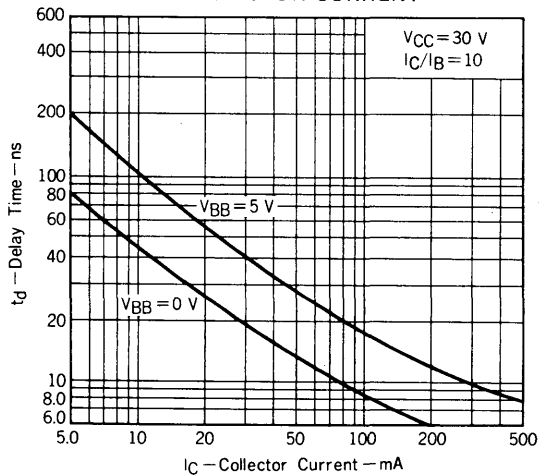

RISE TIME vs. COLLECTOR CURRENT

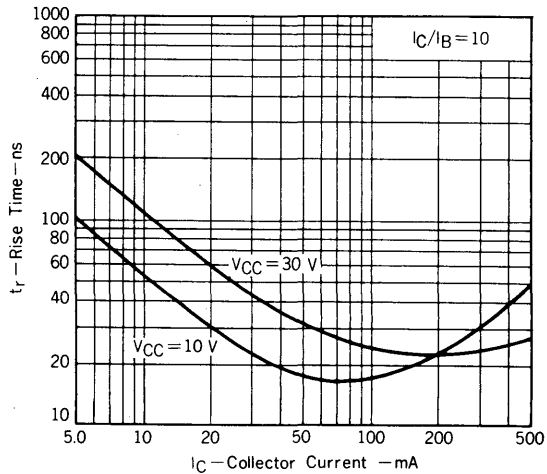

STORAGE TIME vs. COLLECTOR CURRENT

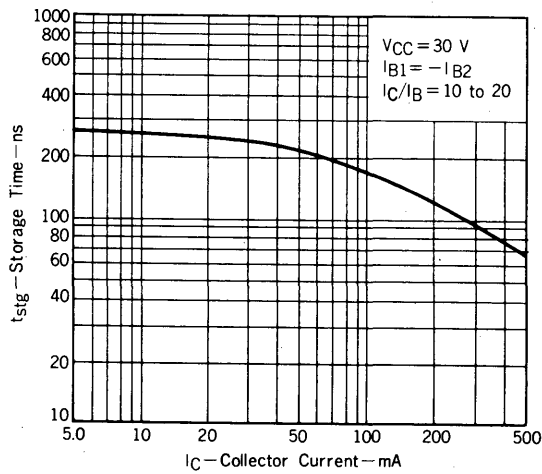

FALL TIME vs. COLLECTOR CURRENT

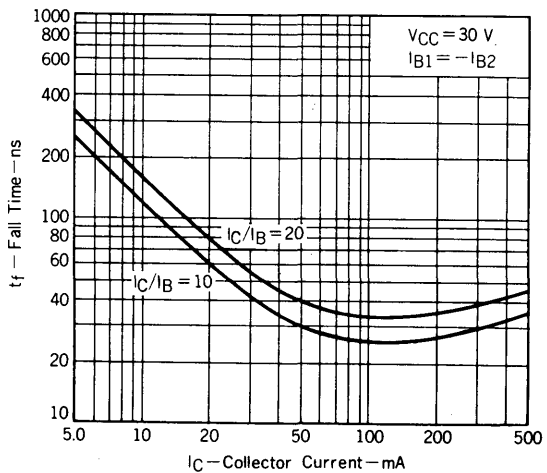



[MEMO]

No part of this document may be copied or reproduced in any form or by any means without the prior written consent of NEC Corporation. NEC Corporation assumes no responsibility for any errors which may appear in this document.

NEC Corporation does not assume any liability for infringement of patents, copyrights or other intellectual property rights of third parties by or arising from use of a device described herein or any other liability arising from use of such device. No license, either express, implied or otherwise, is granted under any patents, copyrights or other intellectual property rights of NEC Corporation or of others.