



Precision, Low-Power, Low-Dropout, SOT23-3 Voltage References

General Description

The MAX6012/MAX6021/MAX6025/MAX6030/MAX6041/MAX6045/MAX6050 precision, low-dropout, micropower voltage references are available in miniature SOT23-3 surface-mount packages. They feature a proprietary curvature-correction circuit and laser-trimmed thin-film resistors that result in a low temperature coefficient of <math>< 15\text{ppm}/^\circ\text{C}</math> and initial accuracy of better than 0.2%. These devices are specified over the extended temperature range.

These series-mode voltage references draw only $27\mu\text{A}$ of quiescent supply current and can sink or source up to $500\mu\text{A}$ of load current. Unlike conventional shunt-mode (two-terminal) references that waste supply current and require an external resistor, devices in the MAX6012 family offer a supply current that's virtually independent of supply voltage (with only a $0.8\mu\text{A}/\text{V}$ variation with supply voltage) and do not require an external resistor. Additionally, these internally compensated devices do not require an external compensation capacitor and are stable with up to 2.2nF of load capacitance. Eliminating the external compensation capacitor saves valuable board area in space-critical applications. Their low dropout voltage and supply-independent, ultra-low supply current make these devices ideal for battery-operated, low-voltage systems.

Applications

Hand-Held Equipment
Data Acquisition Systems
Industrial and Process-Control Systems
Battery-Operated Equipment
Hard-Disk Drives

Selector Guide

PART	OUTPUT VOLTAGE (V)	INPUT VOLTAGE (V)
MAX6012	1.250	2.5 to 12.6
MAX6021	2.048	2.5 to 12.6
MAX6025	2.500	($V_{\text{OUT}} + 200\text{mV}$) to 12.6
MAX6030	3.000	($V_{\text{OUT}} + 200\text{mV}$) to 12.6
MAX6041	4.096	($V_{\text{OUT}} + 200\text{mV}$) to 12.6
MAX6045	4.500	($V_{\text{OUT}} + 200\text{mV}$) to 12.6
MAX6050	5.000	($V_{\text{OUT}} + 200\text{mV}$) to 12.6

Pin Configuration appears at end of data sheet.

Features

- ◆ 0.2% max Initial Accuracy
- ◆ 15ppm/ $^\circ\text{C}$ max Temperature Coefficient
- ◆ 35 μA max Quiescent Supply Current
- ◆ 0.8 $\mu\text{A}/\text{V}$ Supply Current Variation with V_{IN}
- ◆ $\pm 500\mu\text{A}$ Output Source and Sink Current
- ◆ 100mV Dropout at 500 μA Load Current
- ◆ 0.12 $\mu\text{V}/\mu\text{A}$ Load Regulation
- ◆ 8 $\mu\text{V}/\text{V}$ Line Regulation
- ◆ Stable with $C_{\text{LOAD}} = 0$ to 2.2nF

Ordering Information

PART	TEMP. RANGE	PIN-PACKAGE	TOP MARK
MAX6012AEUR-T	-40 $^\circ\text{C}$ to +85 $^\circ\text{C}$	3 SOT23-3	FZAP
MAX6012BEUR-T	-40 $^\circ\text{C}$ to +85 $^\circ\text{C}$	3 SOT23-3	FZDA
MAX6021AEUR-T	-40 $^\circ\text{C}$ to +85 $^\circ\text{C}$	3 SOT23-3	FZAU
MAX6021BEUR-T	-40 $^\circ\text{C}$ to +85 $^\circ\text{C}$	3 SOT23-3	FZDF
MAX6025AEUR-T	-40 $^\circ\text{C}$ to +85 $^\circ\text{C}$	3 SOT23-3	FZAO
MAX6025BEUR-T	-40 $^\circ\text{C}$ to +85 $^\circ\text{C}$	3 SOT23-3	FZDB
MAX6030AEUR-T	-40 $^\circ\text{C}$ to +85 $^\circ\text{C}$	3 SOT23-3	FZDW
MAX6030BEUR-T	-40 $^\circ\text{C}$ to +85 $^\circ\text{C}$	3 SOT23-3	FZDV
MAX6041AEUR-T	-40 $^\circ\text{C}$ to +85 $^\circ\text{C}$	3 SOT23-3	FZAR
MAX6041BEUR-T	-40 $^\circ\text{C}$ to +85 $^\circ\text{C}$	3 SOT23-3	FZDC
MAX6045AEUR-T	-40 $^\circ\text{C}$ to +85 $^\circ\text{C}$	3 SOT23-3	FZAS
MAX6045BEUR-T	-40 $^\circ\text{C}$ to +85 $^\circ\text{C}$	3 SOT23-3	FZDD
MAX6050AEUR-T	-40 $^\circ\text{C}$ to +85 $^\circ\text{C}$	3 SOT23-3	FZAT
MAX6050BEUR-T	-40 $^\circ\text{C}$ to +85 $^\circ\text{C}$	3 SOT23-3	FZDE

Typical Operating Circuit

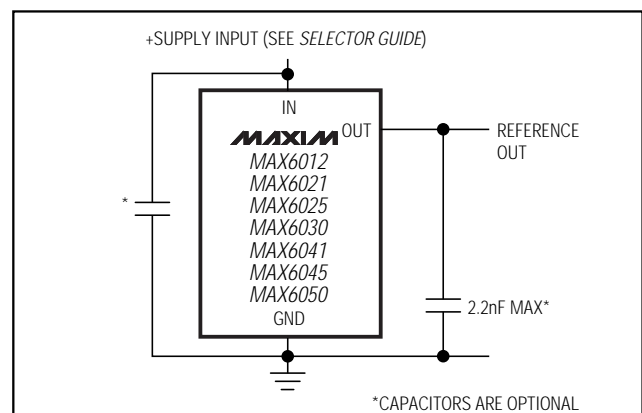

Precision, Low-Power, Low-Dropout, SOT23-3 Voltage References

ABSOLUTE MAXIMUM RATINGS

(Voltages Referenced to GND)

IN	-0.3V to +13.5V
OUT	-0.3V to (V _{IN} + 0.3V)
Output Short Circuit to GND or IN (V _{IN} < 6V)	Continuous
Output Short Circuit to GND or IN (V _{IN} ≥ 6V)	60sec

Continuous Power Dissipation (T_A = +70°C)

3-Pin SOT23-3 (derate 4.0mW/°C above +70°C)	320mW
Operating Temperature Range	-40°C to +85°C
Storage Temperature Range	-65°C to +150°C
Lead Temperature (soldering, 10s)	+300°C

Stresses beyond those listed under "Absolute Maximum Ratings" may cause permanent damage to the device. These are stress ratings only, and functional operation of the device at these or any other conditions beyond those indicated in the operational sections of the specifications is not implied. Exposure to absolute maximum rating conditions for extended periods may affect device reliability.

ELECTRICAL CHARACTERISTICS—MAX6012

(V_{IN} = +5V, I_{OUT} = 0, T_A = T_{MIN} to T_{MAX}, unless otherwise noted. Typical values are at T_A = +25°C.) (Note 1)

PARAMETER	SYMBOL	CONDITIONS	MIN	TYP	MAX	UNITS	
OUTPUT							
Output Voltage	V _{OUT}	T _A = +25°C	MAX6012A	1.246	1.250	1.254	V
				-0.32		0.32	%
			MAX6012B	1.244	1.250	1.256	V
				-0.48		0.48	%
Output Voltage Temperature Coefficient (Note 2)	V _{OUT}	T _A = 0°C to +70°C	MAX6012A		6	15	ppm/°C
		T _A = -40°C to +85°C			6	20	
		T _A = 0°C to +70°C	MAX6012B		6	25	
		T _A = -40°C to +85°C			6	30	
Line Regulation	ΔV _{OUT} /ΔV _{IN}	2.5V ≤ V _{IN} ≤ 12.6V		8	80	μV/V	
Load Regulation	ΔV _{OUT} /ΔI _{OUT}	Sourcing: 0 ≤ I _{OUT} ≤ 500μA		0.12	0.50	μV/μA	
		Sinking: -500μA ≤ I _{OUT} ≤ 0		0.15	0.60		
OUT Short-Circuit Current	I _{SC}	Short to GND		4		mA	
		Short to IN		4			
Temperature Hysteresis (Note 3)				130		ppm	
Long-Term Stability	ΔV _{OUT} /time	1000h at T _A = +25°C		50		ppm/1000h	
DYNAMIC							
Noise Voltage	e _{OUT}	f = 0.1Hz to 10Hz		25		μVp-p	
		f = 10Hz to 10kHz		65		μVRMS	
Ripple Rejection	ΔV _{OUT} /ΔV _{IN}	V _{IN} = 5V ± 100mV, f = 120Hz		86		dB	
Turn-On Settling Time	t _R	To V _{OUT} = 0.1% of final value, C _{OUT} = 50pF		30		μs	
Capacitive-Load Stability Range	C _{OUT}	(Note 4)	0		2.2	nF	
INPUT							
Supply Voltage Range	V _{IN}	Guaranteed by line-regulation test	2.5		12.6	V	
Quiescent Supply Current	I _{IN}			27	35	μA	
Change in Supply Current	I _{IN} /V _{IN}	2.5V ≤ V _{IN} ≤ 12.6V		0.8	2.0	μA/V	

Precision, Low-Power, Low-Dropout, SOT23-3 Voltage References

ELECTRICAL CHARACTERISTICS—MAX6021

($V_{IN} = +5V$, $I_{OUT} = 0$, $T_A = T_{MIN}$ to T_{MAX} , unless otherwise noted. Typical values are at $T_A = +25^\circ C$.) (Note 1)

PARAMETER	SYMBOL	CONDITIONS	MIN	TYP	MAX	UNITS	
OUTPUT							
Output Voltage	V_{OUT}	$T_A = +25^\circ C$	MAX6021A	2.043	2.048	2.053	V
				-0.24		0.24	%
			MAX6021B	2.040	2.048	2.056	V
				-0.39		0.39	%
Output Voltage Temperature Coefficient (Note 2)	V_{OUT}	$T_A = 0^\circ C$ to $+70^\circ C$	MAX6021A	6	15	ppm/ $^\circ C$	
		$T_A = -40^\circ C$ to $+85^\circ C$		6	20		
		$T_A = 0^\circ C$ to $+70^\circ C$	MAX6021B	6	25		
		$T_A = -40^\circ C$ to $+85^\circ C$		6	30		
Line Regulation	$\frac{\Delta V_{OUT}}{\Delta V_{IN}}$	$2.5V \leq V_{IN} \leq 12.6V$		10	100	$\mu V/V$	
Load Regulation	$\frac{\Delta V_{OUT}}{\Delta I_{OUT}}$	Sourcing: $0 \leq I_{OUT} \leq 500\mu A$		0.12	0.55	$\mu V/\mu A$	
		Sinking: $-500\mu A \leq I_{OUT} \leq 0$		0.18	0.70		
OUT Short-Circuit Current	I_{SC}	Short to GND		4		mA	
		Short to IN		4			
Temperature Hysteresis (Note 3)				130		ppm	
Long-Term Stability	$\frac{\Delta V_{OUT}}{\text{time}}$	1000h at $T_A = +25^\circ C$		50		ppm/1000h	
DYNAMIC							
Noise Voltage	e_{OUT}	$f = 0.1\text{Hz}$ to 10Hz		40		μV_{p-p}	
		$f = 10\text{Hz}$ to 10kHz		105		μV_{RMS}	
Ripple Rejection	$\frac{\Delta V_{OUT}}{\Delta V_{IN}}$	$V_{IN} = 5V \pm 100\text{mV}$, $f = 120\text{Hz}$		84		dB	
Turn-On Settling Time	t_R	To $V_{OUT} = 0.1\%$ of final value, $C_{OUT} = 50\text{pF}$		70		μs	
Capacitive-Load Stability Range	C_{OUT}	(Note 4)	0		2.2	nF	
INPUT							
Supply Voltage Range	V_{IN}	Guaranteed by line-regulation test	2.5		12.6	V	
Quiescent Supply Current	I_{IN}			27	35	μA	
Change in Supply Current	I_{IN}/V_{IN}	$2.5V \leq V_{IN} \leq 12.6V$		0.8	2.0	$\mu A/V$	

MAX6012/6021/6025/6030/6041/6045/6050

Precision, Low-Power, Low-Dropout, SOT23-3 Voltage References

MAX6012/6021/6025/6030/6041/6045/6050

ELECTRICAL CHARACTERISTICS—MAX6025

($V_{IN} = +5V$, $I_{OUT} = 0$, $T_A = T_{MIN}$ to T_{MAX} , unless otherwise noted. Typical values are at $T_A = +25^\circ C$.) (Note 1)

PARAMETER	SYMBOL	CONDITIONS	MIN	TYP	MAX	UNITS	
OUTPUT							
Output Voltage	V_{OUT}	$T_A = +25^\circ C$	MAX6025A	2.495	2.500	2.505	V
				-0.20		0.20	%
			MAX6025B	2.490	2.500	2.510	V
				-0.40		0.40	%
Output Voltage Temperature Coefficient (Note 2)	V_{OUT}	$T_A = 0^\circ C$ to $+70^\circ C$	MAX6025A	6	15	ppm/ $^\circ C$	
		$T_A = -40^\circ C$ to $+85^\circ C$		6	20		
		$T_A = 0^\circ C$ to $+70^\circ C$	MAX6025B	6	25		
		$T_A = -40^\circ C$ to $+85^\circ C$		6	30		
Line Regulation	$\frac{\Delta V_{OUT}}{\Delta V_{IN}}$	$(V_{OUT} + 0.2V) \leq V_{IN} \leq 12.6V$		15	140	$\mu V/V$	
Load Regulation	$\frac{\Delta V_{OUT}}{\Delta I_{OUT}}$	Sourcing: $0 \leq I_{OUT} \leq 500\mu A$		0.14	0.60	$\mu V/\mu A$	
		Sinking: $-500\mu A \leq I_{OUT} \leq 0$		0.18	0.80		
Dropout Voltage (Note 5)	$V_{IN} - V_{OUT}$	$I_{OUT} = 500\mu A$		100	200	mV	
OUT Short-Circuit Current	I_{SC}	Short to GND		4		mA	
		Short to IN		4			
Temperature Hysteresis (Note 3)	$\frac{\Delta V_{OUT}}{\text{time}}$			130		ppm	
Long-Term Stability	$\frac{\Delta V_{OUT}}{\text{time}}$	1000h at $T_A = +25^\circ C$		50		ppm/1000h	
DYNAMIC							
Noise Voltage	e_{OUT}	$f = 0.1\text{Hz}$ to 10Hz		60		μV_{p-p}	
		$f = 10\text{Hz}$ to 10kHz		125		μV_{RMS}	
Ripple Rejection	$\frac{\Delta V_{OUT}}{\Delta V_{IN}}$	$V_{IN} = 5V \pm 100\text{mV}$, $f = 120\text{Hz}$		82		dB	
Turn-On Settling Time	t_R	To $V_{OUT} = 0.1\%$ of final value, $C_{OUT} = 50\text{pF}$		85		μs	
Capacitive-Load Stability Range	C_{OUT}	(Note 4)	0		2.2	nF	
INPUT							
Supply Voltage Range	V_{IN}	Guaranteed by line-regulation test	$V_{OUT} + 0.2$		12.6	V	
Quiescent Supply Current	I_{IN}			27	35	μA	
Change in Supply Current	I_{IN}/V_{IN}	$(V_{OUT} + 0.2V) \leq V_{IN} \leq 12.6V$		0.8	2.0	$\mu A/V$	

Precision, Low-Power, Low-Dropout, SOT23-3 Voltage References

ELECTRICAL CHARACTERISTICS—MAX6030

($V_{IN} = +5V$, $I_{OUT} = 0$, $T_A = T_{MIN}$ to T_{MAX} , unless otherwise noted. Typical values are at $T_A = +25^\circ C$.) (Note 1)

PARAMETER	SYMBOL	CONDITIONS	MIN	TYP	MAX	UNITS	
OUTPUT							
Output Voltage	V_{OUT}	$T_A = +25^\circ C$	MAX6030A	2.994	3.000	3.006	V
				-0.20		0.20	%
			MAX6030B	2.988	3.000	3.012	V
				-0.40		0.40	%
Output Voltage Temperature Coefficient (Note 2)	V_{OUT}	$T_A = 0^\circ C$ to $+70^\circ C$	MAX6030A		6	15	ppm/ $^\circ C$
		$T_A = -40^\circ C$ to $+85^\circ C$			6	20	
		$T_A = 0^\circ C$ to $+70^\circ C$	MAX6030B		6	25	
		$T_A = -40^\circ C$ to $+85^\circ C$			6	30	
Line Regulation	$\frac{\Delta V_{OUT}}{\Delta V_{IN}}$	$(V_{OUT} + 0.2V) \leq V_{IN} \leq 12.6V$		20	150	$\mu V/V$	
Load Regulation	$\frac{\Delta V_{OUT}}{\Delta I_{OUT}}$	Sourcing: $0 \leq I_{OUT} \leq 500\mu A$		0.14	0.60	$\mu V/\mu A$	
		Sinking: $-500\mu A \leq I_{OUT} \leq 0$		0.18	0.80		
Dropout Voltage (Note 5)	$V_{IN} - V_{OUT}$	$I_{OUT} = 500\mu A$		100	200	mV	
OUT Short-Circuit Current	I_{SC}	Short to GND		4		mA	
		Short to IN		4			
Temperature Hysteresis (Note 3)				130		ppm	
Long-Term Stability	$\frac{\Delta V_{OUT}}{\text{time}}$	1000h at $T_A = +25^\circ C$		50		ppm/1000h	
DYNAMIC							
Noise Voltage	e_{OUT}	$f = 0.1\text{Hz}$ to 10Hz		75		μV_{p-p}	
		$f = 10\text{Hz}$ to 10kHz		150		μV_{RMS}	
Ripple Rejection	$\frac{\Delta V_{OUT}}{\Delta V_{IN}}$	$V_{IN} = 5V \pm 100\text{mV}$, $f = 120\text{Hz}$		80		dB	
Turn-On Settling Time	t_R	To $V_{OUT} = 0.1\%$ of final value, $C_{OUT} = 50\text{pF}$		100		μs	
Capacitive-Load Stability Range	C_{OUT}	(Note 4)	0		2.2	nF	
INPUT							
Supply Voltage Range	V_{IN}	Guaranteed by line-regulation test	$V_{OUT} + 0.2$		12.6	V	
Quiescent Supply Current	I_{IN}			27	35	μA	
Change in Supply Current	I_{IN}/V_{IN}	$(V_{OUT} + 0.2V) \leq V_{IN} \leq 12.6V$		0.8	2.0	$\mu A/V$	

MAX6012/6021/6025/6030/6041/6045/6050

Precision, Low-Power, Low-Dropout, SOT23-3 Voltage References

ELECTRICAL CHARACTERISTICS—MAX6041

($V_{IN} = +5V$, $I_{OUT} = 0$, $T_A = T_{MIN}$ to T_{MAX} , unless otherwise noted. Typical values are at $T_A = +25^\circ C$.) (Note 1)

PARAMETER	SYMBOL	CONDITIONS	MIN	TYP	MAX	UNITS	
OUTPUT							
Output Voltage	V_{OUT}	$T_A = +25^\circ C$	MAX6041A	4.088	4.096	4.104	V
				-0.20		0.20	%
			MAX6041B	4.080	4.096	4.112	V
				-0.39		0.39	%
Output Voltage Temperature Coefficient (Note 2)	V_{OUT}	$T_A = 0^\circ C$ to $+70^\circ C$	MAX6041A	6	15	ppm/ $^\circ C$	
		$T_A = -40^\circ C$ to $+85^\circ C$		6	20		
		$T_A = 0^\circ C$ to $+70^\circ C$	MAX6041B	6	25		
		$T_A = -40^\circ C$ to $+85^\circ C$		6	30		
Line Regulation	$\frac{\Delta V_{OUT}}{\Delta V_{IN}}$	$(V_{OUT} + 0.2V) \leq V_{IN} \leq 12.6V$		25	160	$\mu V/V$	
Load Regulation	$\frac{\Delta V_{OUT}}{\Delta I_{OUT}}$	Sourcing: $0 \leq I_{OUT} \leq 500\mu A$		0.15	0.70	$\mu V/\mu A$	
		Sinking: $-500\mu A \leq I_{OUT} \leq 0$		0.20	0.90		
Dropout Voltage (Note 5)	$V_{IN} - V_{OUT}$	$I_{OUT} = 500\mu A$		100	200	mV	
OUT Short-Circuit Current	I_{SC}	Short to GND		4		mA	
		Short to IN		4			
Temperature Hysteresis (Note 3)	$\frac{\Delta V_{OUT}}{\text{time}}$	1000h at $T_A = +25^\circ C$		130		ppm	
Long-Term Stability	$\frac{\Delta V_{OUT}}{\text{time}}$	1000h at $T_A = +25^\circ C$		50		ppm/1000h	
DYNAMIC							
Noise Voltage	e_{OUT}	$f = 0.1 \text{ Hz to } 10\text{Hz}$		100		μV_{p-p}	
		$f = 10\text{Hz to } 10\text{kHz}$		200		μV_{RMS}	
Ripple Rejection	$\frac{\Delta V_{OUT}}{\Delta V_{IN}}$	$V_{IN} = 5V \pm 100\text{mV}$, $f = 120\text{Hz}$		77		dB	
Turn-On Settling Time	t_R	To $V_{OUT} = 0.1\%$ of final value, $C_{OUT} = 50\text{pF}$		160		μs	
Capacitive-Load Stability Range	C_{OUT}	(Note 4)	0		2.2	nF	
INPUT							
Supply Voltage Range	V_{IN}	Guaranteed by line-regulation test	$V_{OUT} + 0.2$		12.6	V	
Quiescent Supply Current	I_{IN}			27	35	μA	
Change in Supply Current	I_{IN}/V_{IN}	$(V_{OUT} + 0.2V) \leq V_{IN} \leq 12.6V$		0.8	2.0	$\mu A/V$	

MAX6012/6021/6025/6030/6041/6045/6050

Precision, Low-Power, Low-Dropout, SOT23-3 Voltage References

ELECTRICAL CHARACTERISTICS—MAX6045

($V_{IN} = +5V$, $I_{OUT} = 0$, $T_A = T_{MIN}$ to T_{MAX} , unless otherwise noted. Typical values are at $T_A = +25^\circ C$.) (Note 1)

PARAMETER	SYMBOL	CONDITIONS	MIN	TYP	MAX	UNITS	
OUTPUT							
Output Voltage	V_{OUT}	$T_A = +25^\circ C$	MAX6045A	4.491	4.500	4.509	V
				-0.20		0.20	%
			MAX6045B	4.482	4.500	4.518	V
				-0.40		0.40	%
Output Voltage Temperature Coefficient (Note 2)	V_{OUT}	$T_A = 0^\circ C$ to $+70^\circ C$	MAX6045A		6	15	ppm/ $^\circ C$
		$T_A = -40^\circ C$ to $+85^\circ C$			6	20	
		$T_A = 0^\circ C$ to $+70^\circ C$	MAX6045B		6	25	
		$T_A = -40^\circ C$ to $+85^\circ C$			6	30	
Line Regulation	$\frac{\Delta V_{OUT}}{\Delta V_{IN}}$	$(V_{OUT} + 0.2V) \leq V_{IN} \leq 12.6V$		25	160	$\mu V/V$	
Load Regulation	$\frac{\Delta V_{OUT}}{\Delta I_{OUT}}$	Sourcing: $0 \leq I_{OUT} \leq 500\mu A$		0.16	0.80	$\mu V/\mu A$	
		Sinking: $-500\mu A \leq I_{OUT} \leq 0$		0.22	1.00		
Dropout Voltage (Note 5)	$V_{IN} - V_{OUT}$	$I_{OUT} = 500\mu A$		100	200	mV	
OUT Short-Circuit Current	I_{SC}	Short to GND		4		mA	
		Short to IN		4			
Temperature Hysteresis (Note 3)	$\frac{\Delta V_{OUT}}{\text{time}}$			130		ppm	
Long-Term Stability	$\frac{\Delta V_{OUT}}{\text{time}}$	1000h at $T_A = +25^\circ C$		50		ppm/1000h	
DYNAMIC							
Noise Voltage	e_{OUT}	$f = 0.1\text{Hz}$ to 10Hz		110		μV_{p-p}	
		$f = 10\text{Hz}$ to 10kHz		215		μV_{RMS}	
Ripple Rejection	$\frac{\Delta V_{OUT}}{\Delta V_{IN}}$	$V_{IN} = 5V \pm 100\text{mV}$, $f = 120\text{Hz}$		76		dB	
Turn-On Settling Time	t_R	To $V_{OUT} = 0.1\%$ of final value, $C_{OUT} = 50\text{pF}$		180		μs	
Capacitive-Load Stability Range	C_{OUT}	(Note 4)	0		2.2	nF	
INPUT							
Supply Voltage Range	V_{IN}	Guaranteed by line-regulation test	$V_{OUT} + 0.2$		12.6	V	
Quiescent Supply Current	I_{IN}			27	35	μA	
Change in Supply Current	I_{IN}/V_{IN}	$(V_{OUT} + 0.2V) \leq V_{IN} \leq 12.6V$		0.8	2.0	$\mu A/V$	

MAX6012/6021/6025/6030/6041/6045/6050

Precision, Low-Power, Low-Dropout, SOT23-3 Voltage References

MAX6012/6021/6025/6030/6041/6045/6050

ELECTRICAL CHARACTERISTICS—MAX6050

($V_{IN} = +5.5V$, $I_{OUT} = 0$, $T_A = T_{MIN}$ to T_{MAX} , unless otherwise noted. Typical values are at $T_A = +25^\circ C$.) (Note 1)

PARAMETER	SYMBOL	CONDITIONS	MIN	TYP	MAX	UNITS	
OUTPUT							
Output Voltage	V_{OUT}	$T_A = +25^\circ C$	MAX6050A	4.990	5.000	5.010	V
				-0.20		0.20	%
			MAX6050B	4.980	5.000	5.020	V
				-0.40		0.40	%
Output Voltage Temperature Coefficient (Note 2)	TCV_{OUT}	$T_A = 0^\circ C$ to $+70^\circ C$	MAX6050A	6	15	ppm/ $^\circ C$	
		$T_A = -40^\circ C$ to $+85^\circ C$		6	20		
		$T_A = 0^\circ C$ to $+70^\circ C$	MAX6050B	6	25		
		$T_A = -40^\circ C$ to $+85^\circ C$		6	30		
Line Regulation	$\frac{\Delta V_{OUT}}{\Delta V_{IN}}$	$(V_{OUT} + 0.2V) \leq V_{IN} \leq 12.6V$		25	160	$\mu V/V$	
Load Regulation	$\frac{\Delta V_{OUT}}{\Delta I_{OUT}}$	Sourcing: $0 \leq I_{OUT} \leq 500\mu A$		0.17	0.85	$\mu V/\mu A$	
		Sinking: $-500\mu A \leq I_{OUT} \leq 0$		0.24	1.10		
Dropout Voltage (Note 5)	$V_{IN} - V_{OUT}$	$I_{OUT} = 500\mu A$		100	200	mV	
OUT Short-Circuit Current	I_{SC}	Short to GND		4		mA	
		Short to IN		4			
Temperature Hysteresis (Note 3)				130		ppm	
Long-Term Stability	$\frac{\Delta V_{OUT}}{\text{time}}$	1000h at $T_A = +25^\circ C$		50		ppm/1000h	
DYNAMIC							
Noise Voltage	e_{OUT}	$f = 0.1 \text{ Hz to } 10\text{Hz}$		120		μV_{p-p}	
		$f = 10\text{Hz to } 10\text{kHz}$		240		μV_{RMS}	
Ripple Rejection	$\frac{\Delta V_{OUT}}{\Delta V_{IN}}$	$V_{IN} = 5V \pm 100\text{mV}$, $f = 120\text{Hz}$		72		dB	
Turn-On Settling Time	t_R	To $V_{OUT} = 0.1\%$ of final value, $C_{OUT} = 50\text{pF}$		220		μs	
Capacitive-Load Stability Range	C_{OUT}	(Note 4)	0		2.2	nF	
INPUT							
Supply Voltage Range	V_{IN}	Guaranteed by line-regulation test	$V_{OUT} + 0.2$		12.6	V	
Quiescent Supply Current	I_{IN}			27	35	μA	
Change in Supply Current	I_{IN}/V_{IN}	$(V_{OUT} + 0.2V) \leq V_{IN} \leq 12.6V$		0.8	2.0	$\mu A/V$	

Note 1: All devices are 100% production tested at $T_A = +25^\circ C$ and are guaranteed by design for $T_A = T_{MIN}$ to T_{MAX} , as specified.

Note 2: Temperature Coefficient is measured by the "box" method, i.e., the maximum ΔV_{OUT} is divided by the maximum ΔT .

Note 3: Temperature Hysteresis is defined as the change in $+25^\circ C$ output voltage before and after cycling the device from T_{MIN} to T_{MAX} .

Note 4: Not production tested. Guaranteed by design.

Note 5: Dropout voltage is the minimum input voltage at which V_{OUT} changes $\leq 0.2\%$ from V_{OUT} at $V_{IN} = 5.0V$ ($V_{IN} = 5.5V$ for MAX6050).

Precision, Low-Power, Low-Dropout, SOT23-3 Voltage References

Typical Operating Characteristics

($V_{IN} = +5V$ for MAX6012/21/25/30/41/45, $V_{IN} = +5.5V$ for MAX6050; $I_{OUT} = 0$; $T_A = +25^\circ C$; unless otherwise noted.) (Note 6)

MAX6012/6021/6025/6030/6041/6045/6050

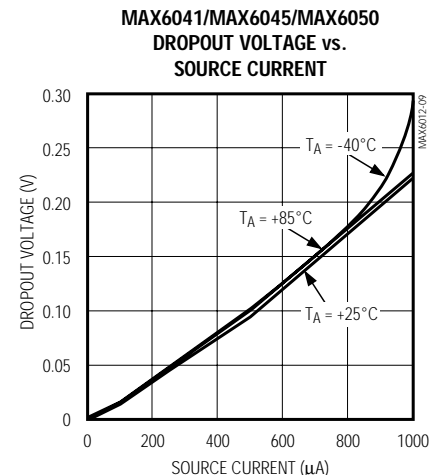
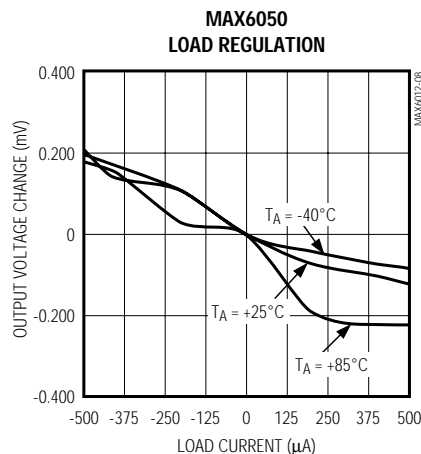
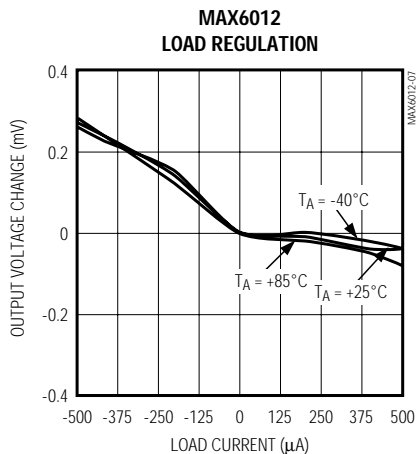
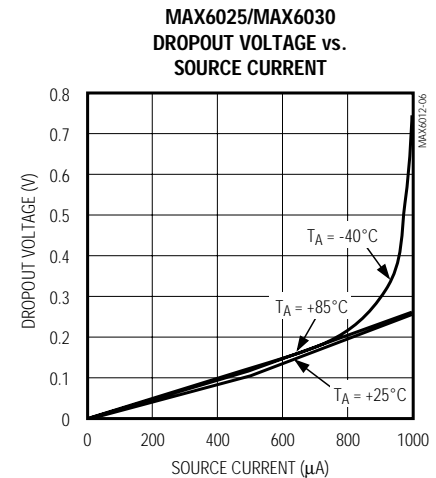
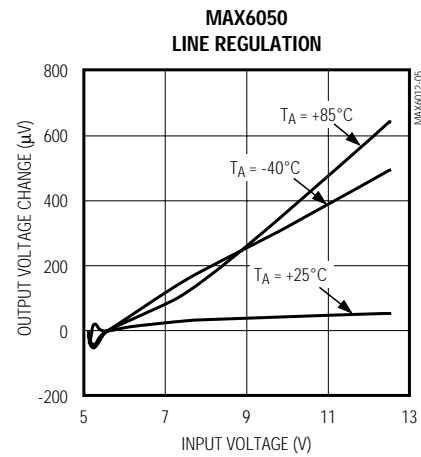
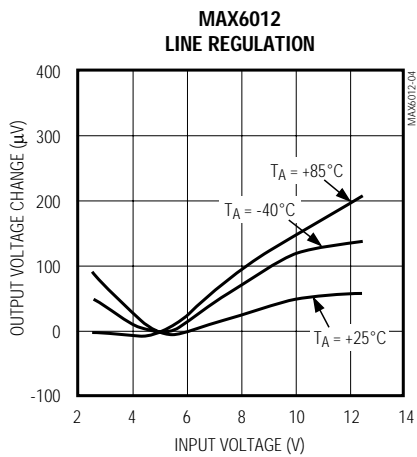
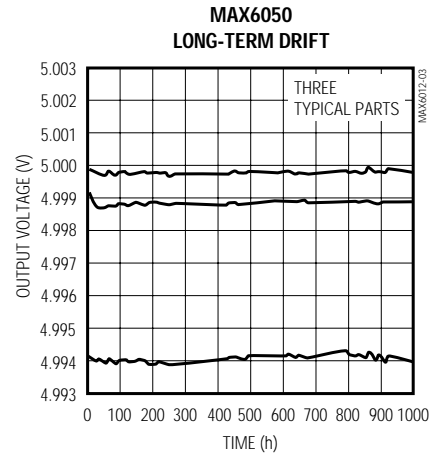
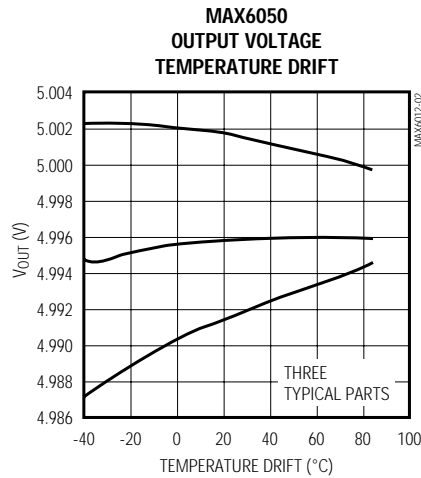
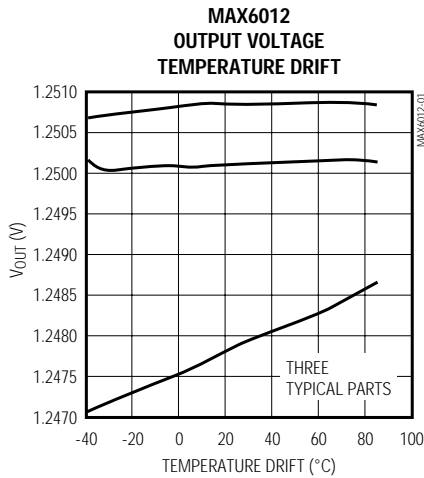

Precision, Low-Power, Low-Dropout, SOT23-3 Voltage References

Typical Operating Characteristics (continued)

($V_{IN} = +5V$ for MAX6012/21/25/30/41/45, $V_{IN} = +5.5V$ for MAX6050; $I_{OUT} = 0$; $T_A = +25^\circ C$; unless otherwise noted.) (Note 6)

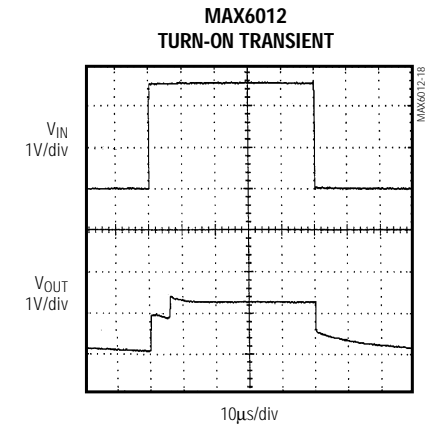
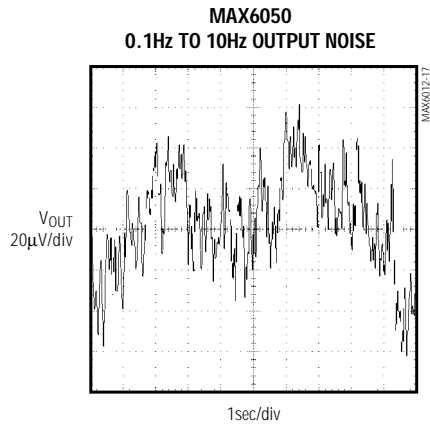
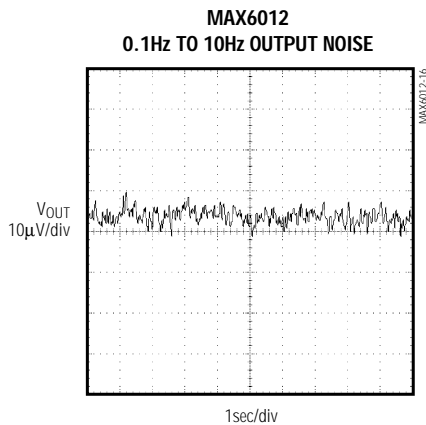
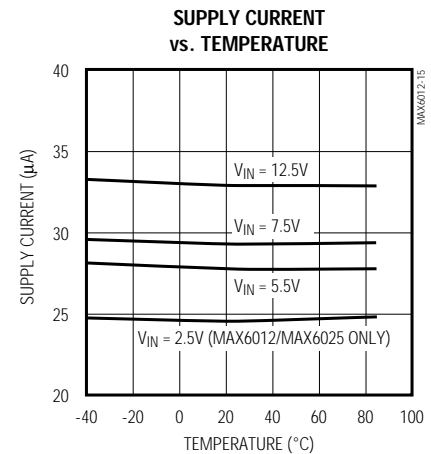
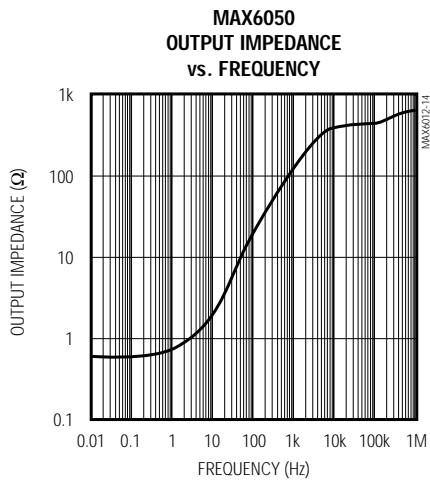
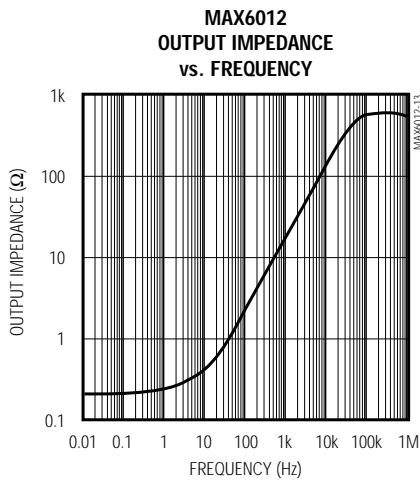
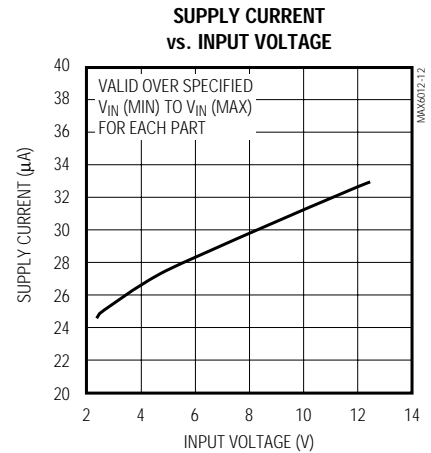
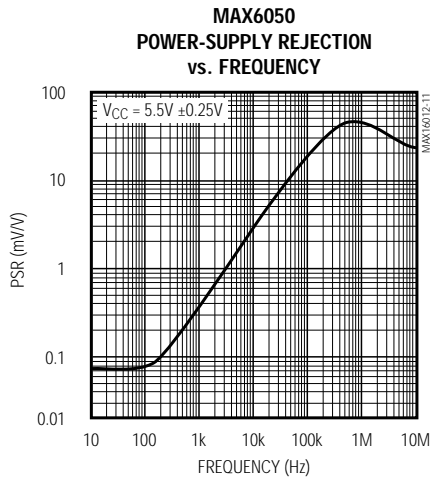
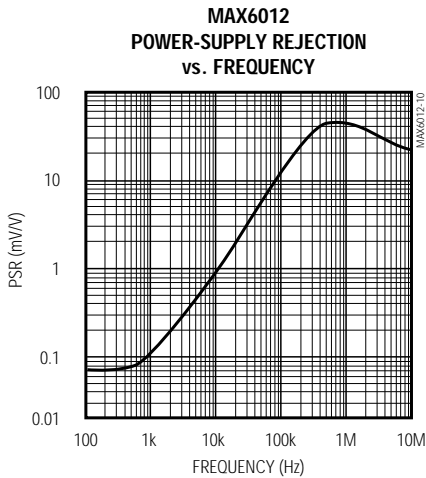

Precision, Low-Power, Low-Dropout, SOT23-3 Voltage References

Typical Operating Characteristics (continued)

($V_{IN} = +5V$ for MAX6012/21/25/30/41/45, $V_{IN} = +5.5V$ for MAX6050; $I_{OUT} = 0$; $T_A = +25^\circ C$; unless otherwise noted.) (Note 6)

MAX6012/6021/6025/6030/6041/6045/6050

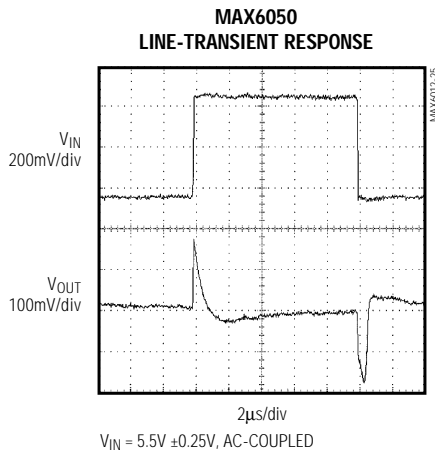
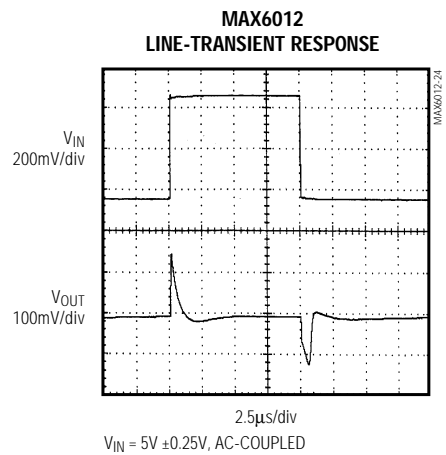
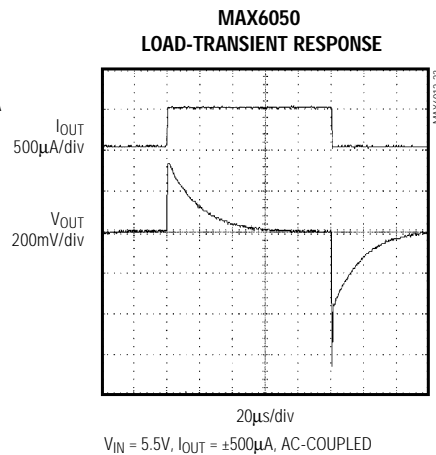
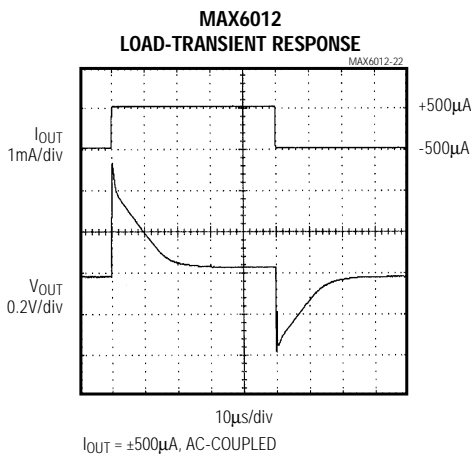
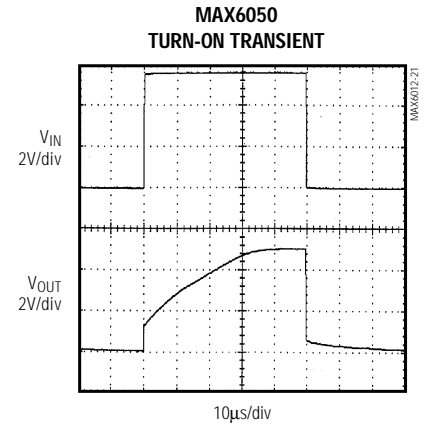
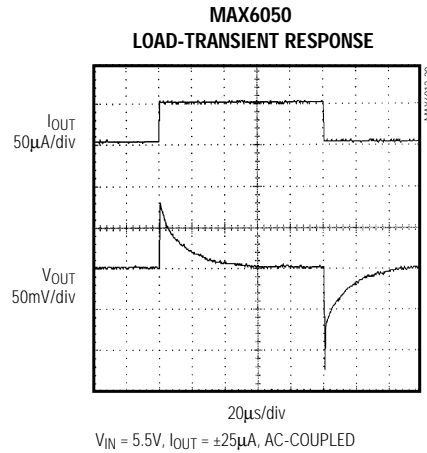
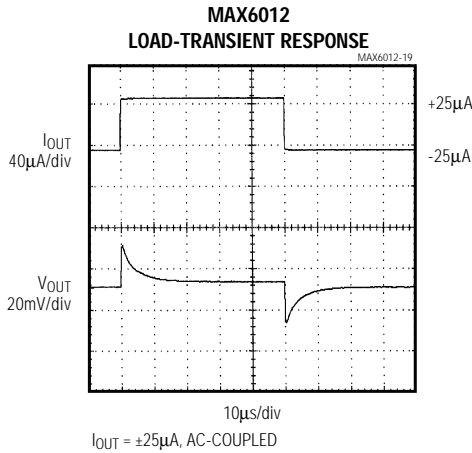

Note 6: Many of the *Typical Operating Characteristics* of the MAX6012 family are extremely similar. The extremes of these characteristics are found in the MAX6012 (1.2V output) and the MAX6050 (5.0V output). The *Typical Operating Characteristics* of the remainder of the MAX6012 family typically lie between these two extremes and can be estimated based on their output voltage.

Precision, Low-Power, Low-Dropout, SOT23-3 Voltage References

Pin Description

PIN	NAME	FUNCTION
1	IN	Supply Voltage Input
2	OUT	Reference Voltage Output
3	GND	Ground

Detailed Description

The MAX6012/MAX6021/MAX6025/MAX6030/MAX6041/MAX6045/MAX6050 precision bandgap references use a proprietary curvature-correction circuit and laser-trimmed thin-film resistors, resulting in a low temperature coefficient of <math><20\text{ppm}/^\circ\text{C}</math> and initial accuracy of better than 0.2%. These devices can sink and source up to 500 μA with <math><200\text{mV}</math> of dropout voltage, making them attractive for use in low-voltage applications.

Applications Information

Output/Load Capacitance

Devices in this family do not require an output capacitance for frequency stability. They are stable for capacitive loads from 0 to 2.2nF. However, in applications where the load or the supply can experience step changes, an output capacitor will reduce the amount of overshoot (or undershoot) and assist the circuit's transient response. Many applications do not need an external capacitor, and this family can offer a significant advantage in these applications when board space is critical.

Supply Current

The quiescent supply current of these series-mode references is a maximum of 35 μA and is virtually independent of the supply voltage, with only a 0.8 $\mu\text{A}/\text{V}$ variation with supply voltage. Unlike series references, shunt-mode references operate with a series resistor connected to the power supply. The quiescent current of a shunt-mode reference is thus a function of the input voltage. Additionally, shunt-mode references have to be biased at the maximum expected load current, even if the load current is not present all the time. The load current is drawn from the input voltage only when required, so supply current is not wasted and efficiency is maximized at all input voltages. This improved efficiency can help reduce power dissipation and extend battery life.

When the supply voltage is below the minimum specified input voltage (as during turn-on), the devices can draw up to 200 μA beyond the nominal supply current. The input voltage source must be capable of providing this current to ensure reliable turn-on.

Output Voltage Hysteresis

Output voltage hysteresis is the change in the output voltage at $T_A = +25^\circ\text{C}$ before and after the device is cycled over its entire operating temperature range. Hysteresis is caused by differential package stress appearing across the bandgap core transistors. The typical temperature hysteresis value is 130ppm.

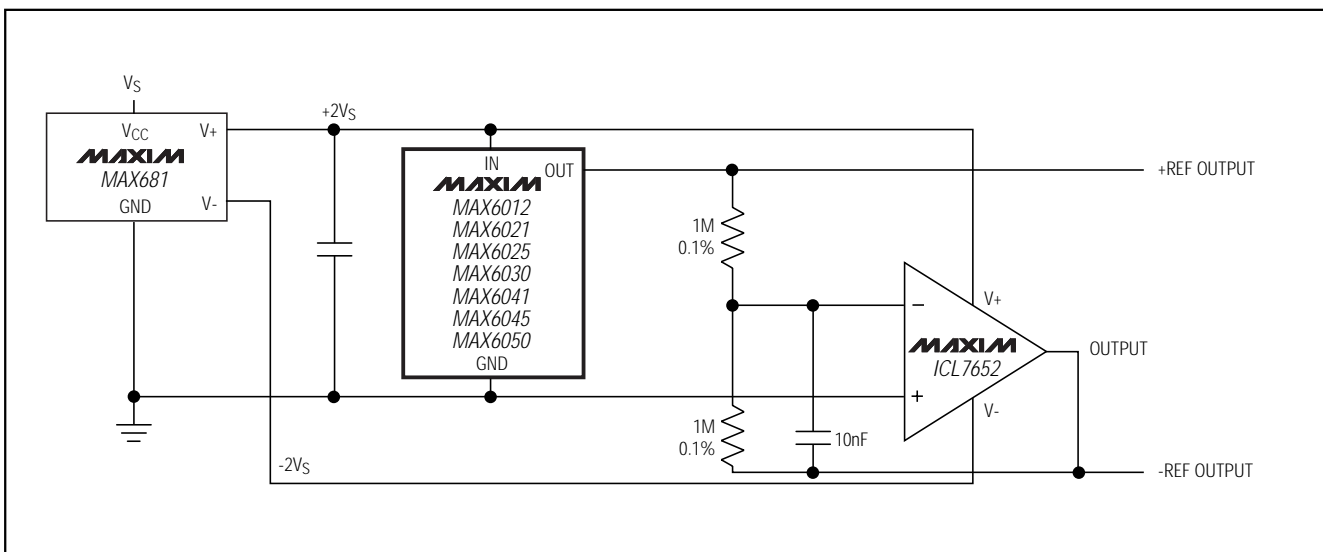

Figure 1. Positive and Negative References from Single +3V or +5V Supply

Precision, Low-Power, Low-Dropout, SOT23-3 Voltage References

Turn-On Time

These devices typically turn on and settle to within 0.1% of their final value; 30 μ s to 220 μ s depending on the device. The turn-on time can increase up to 1.5ms with the device operating at the minimum dropout voltage and the maximum load.

Positive and Negative Low-Power Voltage Reference

Figure 1 shows a typical method for developing a bipolar reference. The circuit uses a MAX681 voltage doubler/inverter charge-pump converter to power an ICL7652, thus creating a positive as well as a negative reference voltage.

Pin Configuration

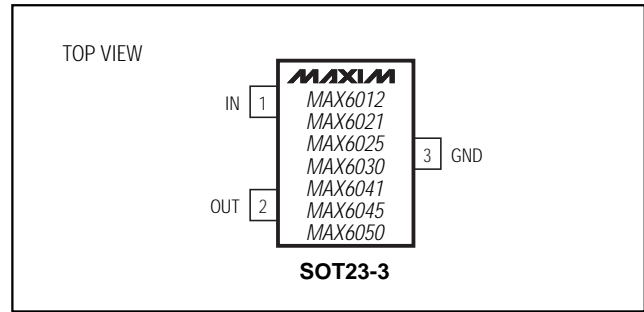

Chip Information

TRANSISTOR COUNT: 70

MAX6012/6021/6025/6030/6041/6045/6050

Precision, Low-Power, Low-Dropout, SOT23-3 Voltage References

Package Information

NOTES:
 1. DIMS DO NOT INCLUDE MOLD FLASH.
 2. MOLD FLASH OR PROTRUSIONS NOT TO EXCEED .15mm (.006")
 3. CONTROLLING DIMENSION: MILLIMETER

DIM	INCHES		MILLIMETERS	
	MIN	MAX	MIN	MAX
A	0.031	0.047	0.787	1.194
A1	0.001	0.005	0.025	0.127
B	0.014	0.022	0.356	0.559
C	0.0034	0.006	0.086	0.152
D	0.105	0.120	2.667	3.048
E	0.047	0.055	1.194	1.397
e	0.070	0.080	1.778	2.032
H	0.082	0.098	2.083	2.489
L	0.004	0.012	0.102	0.305
S	0.017	0.022	0.432	0.559
α	0°	B°	D°	8°

REFLECTIVE INFORMATION

TITLE: PACKAGE OUTLINE, SOT-23, 3L

SHEET NO.	DRAWING CONTROL NO.	REV
21-0051		C 1/1

OUTLINE

*Precision, Low-Power, Low-Dropout,
SOT23-3 Voltage References*

NOTES

MAX6012/6021/6025/6030/6041/6045/6050

Precision, Low-Power, Low-Dropout, SOT23-3 Voltage References

NOTES

MAX6012/6021/6025/6030/6041/6045/6050

Maxim cannot assume responsibility for use of any circuitry other than circuitry entirely embodied in a Maxim product. No circuit patent licenses are implied. Maxim reserves the right to change the circuitry and specifications without notice at any time.

16 _____ Maxim Integrated Products, 120 San Gabriel Drive, Sunnyvale, CA 94086 408-737-7600