

Cascadable Silicon Bipolar MMIC Amplifiers

Technical Data

MSA-0635, -0636

Features

- **Cascadable 50 Ω Gain Block**
- **Low Operating Voltage:**
3.5 V Typical V_d
- **3 dB Bandwidth:**
DC to 0.9 GHz
- **High Gain:**
19.0 dB Typical at 0.5 GHz
- **Low Noise Figure:**
2.8 dB Typical at 0.5 GHz
- **Cost Effective Ceramic Microstrip Package**

Description

The MSA-0635 is a high performance silicon bipolar Monolithic Microwave Integrated Circuit (MMIC) housed in a cost effective, microstrip package. This MMIC is

designed for use as a general purpose 50 Ω gain block. Typical applications include narrow and broad band IF and RF amplifiers in commercial and industrial applications.

The MSA-series is fabricated using HP's 10 GHz f_T , 25 GHz f_{MAX} , silicon bipolar MMIC process which uses nitride self-alignment, ion implantation, and gold metallization to achieve excellent performance, uniformity and reliability. The use of an external bias resistor for temperature and current stability also allows bias flexibility.

Available in cut lead version (package 36) as MSA-0636.

35 micro-X Package^[1]

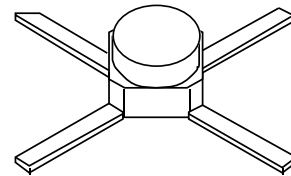

Note:

1. Short leaded 36 package available upon request.

Typical Biasing Configuration

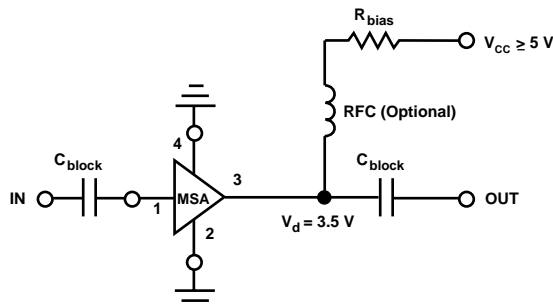

MSA-0635, -0636 Absolute Maximum Ratings

Parameter	Absolute Maximum ^[1]
Device Current	50 mA
Power Dissipation ^[2,3]	200 mW
RF Input Power	+13 dBm
Junction Temperature	200°C
Storage Temperature ^[4]	-65 to 200°C

Thermal Resistance^[2,5]:

$$\theta_{jc} = 155^{\circ}\text{C/W}$$

Notes:

1. Permanent damage may occur if any of these limits are exceeded.
2. $T_{\text{CASE}} = 25^{\circ}\text{C}$.
3. Derate at $6.5 \text{ mW}/^{\circ}\text{C}$ for $T_{\text{C}} > 169^{\circ}\text{C}$.
4. Storage above $+150^{\circ}\text{C}$ may tarnish the leads of this package making it difficult to solder into a circuit.
5. The small spot size of this technique results in a higher, though more accurate determination of θ_{jc} than do alternate methods. See MEASUREMENTS section "Thermal Resistance" for more information.

Electrical Specifications^[1], $T_{\text{A}} = 25^{\circ}\text{C}$

Symbol	Parameters and Test Conditions: $I_{\text{d}} = 16 \text{ mA}$, $Z_{\text{o}} = 50 \Omega$	Units	Min.	Typ.	Max.
G_{P}	Power Gain ($ S_{21} ^2$) $f = 0.1 \text{ GHz}$	dB	19.0	20.5	22.0
ΔG_{P}	Gain Flatness $f = 0.1 \text{ to } 2.5 \text{ GHz}$	dB		± 0.7	± 1.0
$f_{3 \text{ dB}}$	3 dB Bandwidth	GHz		0.9	
VSWR	Input VSWR $f = 0.1 \text{ to } 1.5 \text{ GHz}$			1.4:1	
	Output VSWR $f = 0.1 \text{ to } 1.5 \text{ GHz}$			1.3:1	
NF	50 Ω Noise Figure $f = 0.5 \text{ GHz}$	dB		2.8	4.0
$P_{1 \text{ dB}}$	Output Power at 1 dB Gain Compression $f = 0.5 \text{ GHz}$	dBm		2.0	
IP_3	Third Order Intercept Point $f = 0.5 \text{ GHz}$	dBm		14.5	
t_{D}	Group Delay $f = 0.5 \text{ GHz}$	psec		200	
V_{d}	Device Voltage	V	3.1	3.5	3.9
dV/dT	Device Voltage Temperature Coefficient	$\text{mV}/^{\circ}\text{C}$		-8.0	

Note:

1. The recommended operating current range for this device is 12 to 30 mA. Typical performance as a function of current is on the following page.

MSA-0635, -0636 Typical Scattering Parameters ($Z_0 = 50 \Omega$, $T_A = 25^\circ\text{C}$, $I_d = 16 \text{ mA}$)

Freq. GHz	S ₁₁		S ₂₁			S ₁₂			S ₂₂		k
	Mag	Ang	dB	Mag	Ang	dB	Mag	Ang	Mag	Ang	
0.1	.03	-178	20.5	10.59	171	-23.4	.068	5	.04	-44	1.05
0.2	.02	-177	20.3	10.31	161	-22.9	.071	8	.05	-68	1.04
0.3	.02	-164	20.0	9.96	152	-22.4	.076	14	.06	-87	1.04
0.4	.02	-116	19.6	9.55	144	-22.0	.079	19	.07	-104	1.03
0.5	.02	-100	19.2	9.08	136	-21.8	.081	21	.09	-114	1.04
0.6	.04	-89	18.7	8.59	128	-21.3	.086	24	.09	-123	1.04
0.8	.07	-96	17.7	7.66	115	-20.2	.098	29	.10	-140	1.03
1.0	.10	-108	16.6	6.79	103	-19.4	.107	31	.11	-156	1.02
1.5	.17	-134	14.2	5.13	79	-17.2	.138	30	.12	172	1.03
2.0	.24	-160	12.1	4.01	60	-15.8	.163	26	.12	148	1.04
2.5	.31	-178	10.3	3.26	48	-15.1	.175	27	.12	140	1.08
3.0	.37	166	8.7	2.72	34	-14.4	.190	24	.11	135	1.10
3.5	.42	151	7.4	2.33	21	-13.9	.203	19	.10	144	1.11
4.0	.46	139	6.2	2.04	9	-13.3	.216	16	.08	167	1.11
4.5	.48	126	5.1	1.81	-3	-12.8	.229	12	.08	-173	1.11
5.0	.52	110	4.2	1.62	-15	-12.2	.245	8	.09	-173	1.09

Note:

1. A model for this device is available in the DEVICE MODELS section.

Typical Performance, $T_A = 25^\circ\text{C}$

(unless otherwise noted)

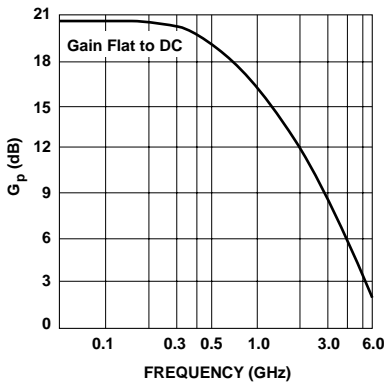

Figure 1. Typical Power Gain vs. Frequency, $I_d = 16 \text{ mA}$.

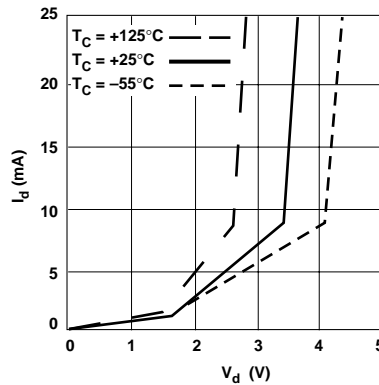

Figure 2. Device Current vs. Voltage.

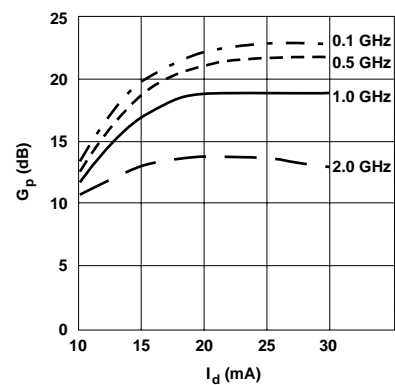

Figure 3. Power Gain vs. Current.

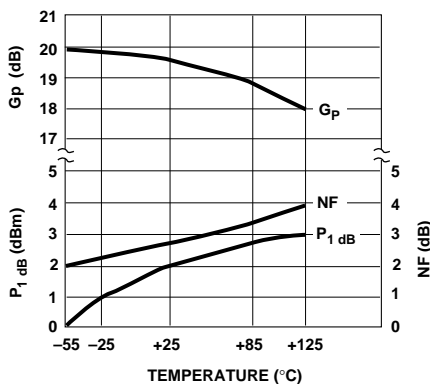

Figure 4. Output Power at 1 dB Gain Compression, NF and Power Gain vs. Case Temperature, $f = 0.5 \text{ GHz}$, $I_d = 16 \text{ mA}$.

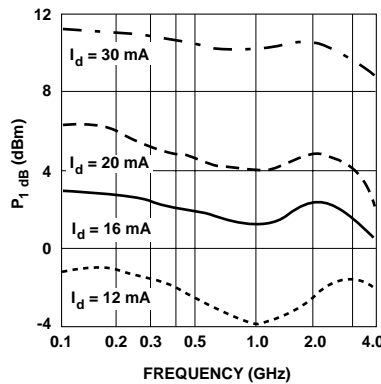

Figure 5. Output Power at 1 dB Gain Compression vs. Frequency.

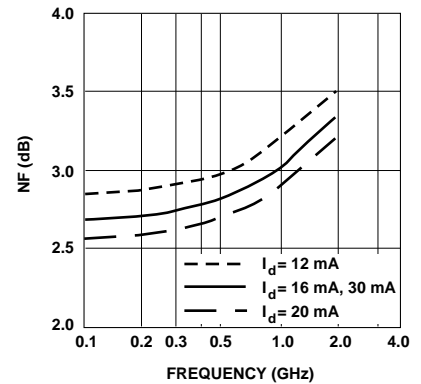

Figure 6. Noise Figure vs. Frequency.

35 micro-X Package Dimensions

