



PC Card (PCMCIA) Interface Switch—12-V Suspend Capability

FEATURES

- Programmable V_{CC} Ramp
- Smart Switching
- 12-V Sleepmode Compatible
- Extremely Low R_{ON}
- Reverse Blocking Switches
- V_{PP} Programmable to 0, 12-V or V_{CC}
- Safe Power-Up
- Low Power Consumption
- PC Card 3-V/5-V Compatible
- Logic Compatible Inputs
- Single SO-16 Package

DESCRIPTION

The Si9712 combines low on-resistance with slow ramp time and smart switching for overall best performance in integrated PC Card interface switches.

The Si9712 operates off the 5-V supply and has built-in level shifting for gate drive. Internal logic protects against an external control input error that would short 5 V to the 3.3-V supply. This protection logic also allows the Si9712 to be configured for positive or negative control logic for compatibility with a variety of PC Card controllers. These control inputs are CMOS logic compatible and can be driven to 3.3 V or 5 V.

The Si9712 complies with the release of the PC Card standard by supplying 0 V, 12 V, and V_{CC} to the V_{PP} output and 0 V, 3.3 V, and 5 V to the V_{CC} output. The V_{CC} ramp time is user programmable with an external capacitor connected to the SR pin.

The PC Card switch is packaged in a narrow body SO-16 package and is rated over the industrial temperature range -40 to 85°C .

The Si9712 is available in both standard and lead (Pb)-free packages.

FUNCTIONAL BLOCK DIAGRAM

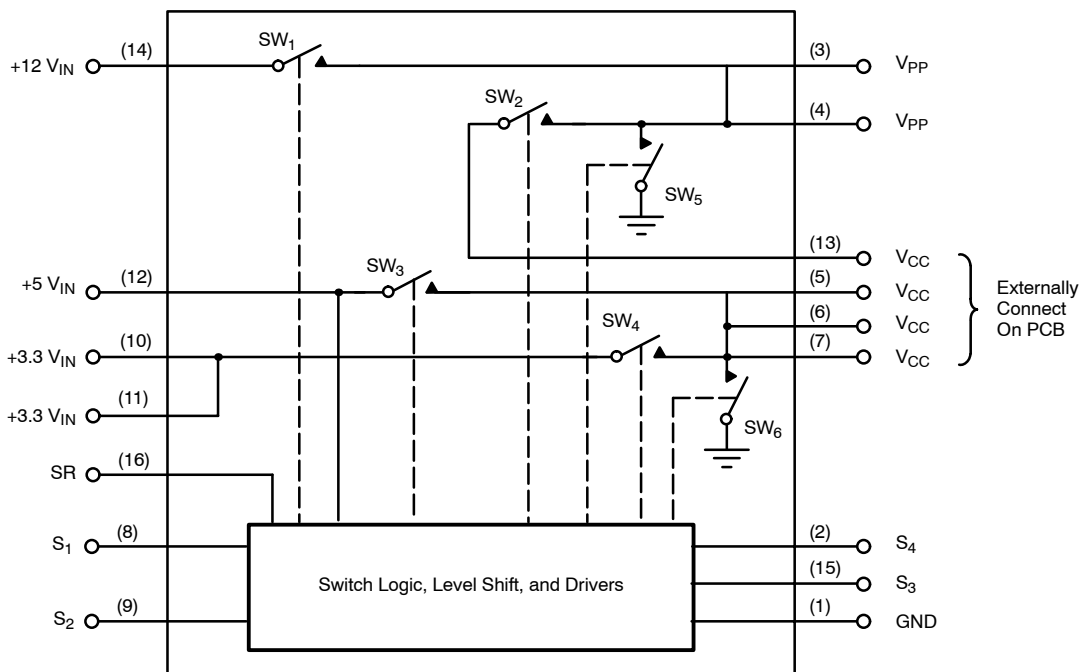



ABSOLUTE MAXIMUM RATINGS

Voltages Referenced to Ground	
+12 V _{IN}	15 V
+5 V _{IN}	7 V
+3.3 V _{IN} ^c	7 V
S ₁ through S ₄ (CMOS Inputs)	7 V
I _{OUT} V _{PP} ^a	300 mA
All Pins	-0.5 V
I _{OUT} V _{CC} ^b	4 A

PD Max: (T _A = 25°C)	2.5 W
(T _A = 85°C)	1.0 W
Junction Temperature	125°C
Thermal Rating—R _{ΘJA}	40 °C/W

Notes

- Pins 3, 4 connected together externally.
- Pins 5, 6, 7, 13 connected together externally.
- Pins 10, 11 connected together externally.

RECOMMENDED OPERATING CONDITIONS

+12 V _{IN}	0 or 12 V ± 10%
+5 V _{IN} (must be present)	5 V ± 10%
+3.3 V _{IN} ^c	3.3 V ± 10%
C _{SR}	33 nF
I _{OUT} V _{PP} ^a	150 mA
I _{OUT} V _{CC} ^b	2 A

V _{PP} Load Capacitance	10 μF Max
V _{CC} Load Capacitance	150 μF Max

Notes

- Pins 3, 4 connected together externally.
- Pins 5, 6, 7, 13 connected together externally.
- Pins 10, 11 connected together externally.

SPECIFICATIONS							
Parameter	Symbol	Test Conditions Unless Otherwise Specified		Limits -40 to 85°C			Unit
		C _{SR} = 33 nF, +12 V _{IN} = 12 V, +5 V _{IN} = 5 V +3.3 V _{IN} = 3.3 V, Low ≤ 0.8 V, High ≥ 2.2 V		Min ^a	Typ ^b	Max ^a	
Switch 1							
On-Resistance	R _{ON}	I = 120 mA, +12 V _{IN} = 11.4 V S ₃ = S ₁ = High S ₂ = S ₄ = Low	T _A = 25°C			120	mΩ
			T _A = 85°C			145	
Off Current (+12 V _{IN})	I _{OFF}	+12 V _{IN} = 12.6 V S ₁ = Low	T _A = 25°C			1	μA
			T _A = 85°C			10	
Switching Time	t _{SW1(on)}	S ₂ = S ₄ = Low, See Figure 1 S ₃ = High		50	200	350	μs
	t _{SW1(off)}				1.0	10	
Delay Time	t _{d(on)}	See Figure 3 S ₂ = S ₄ = Low		1.0	6	20	ms
	t _{d(off)}			0.1	2.9	10	
Rise Time	t _{SW1(on)}	S ₂ = S ₄ = Low, S ₃ = High, See Figure 2		50	150	300	μs
Switch 2							
On-Resistance	R _{ON}	I = 120 mA, S ₂ = S ₃ = High S ₁ = S ₄ = Low	T _A = 25°C			150	mΩ
			T _A = 85°C			180	
Switching Time	t _{SW2(on)}	S ₁ = S ₄ = Low, S ₃ = High, See Figure 1		50	200	350	μs
	t _{SW2(off)}				1.0	10	
Delay Time	t _{d(on)}	S ₁ = S ₄ = Low, See Figure 3		1.0	6	20	ms
	t _{d(off)}			0.1	1.7	10	
Rise Time	t _{SW2(on)}	S ₁ = S ₄ = Low, S ₃ = High, See Figure 2		50	150	300	μs
Switch 3							
On-Resistance	R _{ON}	I = 500 mA, S ₃ = High S ₁ = S ₂ = S ₄ = Low	T _A = 25°C			70	mΩ
			T _A = 85°C			95	
Off Current (V _{CC})	I _{OFF}	+5 V _{IN} = 5.5 V, V _{CC} = 0 V S ₁ = S ₂ = S ₃ = Low S ₄ = High +3.3 V _{IN} = Open Circuit	T _A = 25°C			1	μA
			T _A = 85°C			10	
Rise Time	t _{SW3(on)}	S ₁ = S ₂ = S ₄ = Low, See Figure 2		0.1	1.7	10	ms
Fall Time	t _{SW3(off)}			3	30	50	



SPECIFICATIONS							
Parameter	Symbol	Test Conditions Unless Otherwise Specified $C_{SR} = 33 \text{ nF}$, $+12 \text{ V}_{IN} = 12 \text{ V}$, $+5 \text{ V}_{IN} = 5 \text{ V}$ $+3.3 \text{ V}_{IN} = 3.3 \text{ V}$, Low $\leq 0.8 \text{ V}$, High $\geq 2.2 \text{ V}$		Limits -40 to 85°C			Unit
				Min ^a	Typ ^b	Max ^a	
Switch 4							
On-Resistance	R_{ON}	$I = 500 \text{ mA}$, $S_4 = \text{High}$ $S_1 = S_2 = S_3 = \text{Low}$	$T_A = 25^\circ\text{C}$			50	m Ω
			$T_A = 85^\circ\text{C}$			70	
Off Current (+3.3 V _{IN})	I_{OFF}	$+3.3 \text{ V}_{IN} = 3.6 \text{ V}$, $S_1 = S_2 = S_3 = S_4 = \text{Low}$	$T_A = 25^\circ\text{C}$			1	μA
			$T_A = 85^\circ\text{C}$			10	
Rise Time	$t_{SW4(on)}$	$S_1 = S_2 = S_3 = \text{Low}$, See Figure 2		0.1	0.9	10	ms
Fall Time	$t_{SW4(off)}$			3	20	40	
Switch 5							
On-Resistance	R_{ON}	$I = 2 \text{ mA}$, $S_1 = S_2 = \text{Low}$	$T_A = 25^\circ\text{C}$		235	400	Ω
			$T_A = 85^\circ\text{C}$		325	550	
Switch 6							
On-Resistance	R_{ON}	$I = 2 \text{ mA}$, $S_3 = S_4 = \text{Low}$	$T_A = 25^\circ\text{C}$		140	400	Ω
			$T_A = 85^\circ\text{C}$		200	500	
Power Supply							
+5 V _{IN} Current Input (on)	$I_{+5VIN(1)}$	$S_1 = S_4 = 0 \text{ V}$, $S_2 = S_3 = 3 \text{ V}$			20	50	μA
	$I_{+5VIN(2)}$	$S_1 = S_4 = 3 \text{ V}$, $S_2 = S_3 = 0 \text{ V}$			20	50	
+5 V _{IN} Current Input (off)	$I_{+5VIN(3)}$	$S_1 = S_2 = S_3 = S_4 = 0 \text{ V}$			<1	10	
Switch Control Inputs							
Input Voltage High	$V_{I(H)}$	$+5 \text{ V}_{IN} = 5.5 \text{ V}$		2.2	1.8		V
		$+5 \text{ V}_{IN} = 4.5 \text{ V}$		2.2	1.6		
Input Voltage Low	$V_{I(L)}$	$+5 \text{ V}_{IN} = 5.5 \text{ V}$			1.6	0.8	
		$+5 \text{ V}_{IN} = 4.5 \text{ V}$			1.4	0.8	
Input Current High	$I_{I(H)}$	S_1 through $S_4 = 5 \text{ V}$				1.0	μA
Input Current Low	$I_{I(L)}$	S_1 through $S_4 = \text{GND}$		-1.0			

Notes

- a. The algebraic convention whereby the most negative value is a minimum and the most positive a maximum.
- b. Typical values are for DESIGN AID ONLY, not guaranteed nor subject to production testing.

TIMING WAVEFORMS

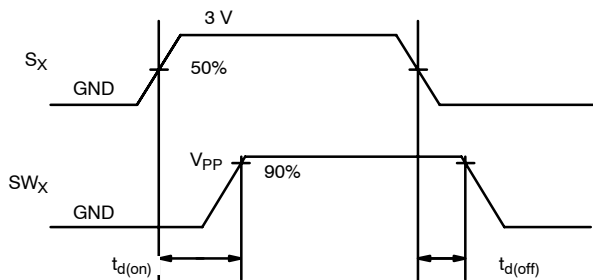

FIGURE 1. V_{PP} Switch Delay

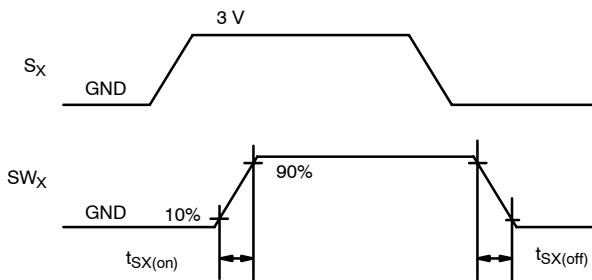

FIGURE 2. Switch Ramp

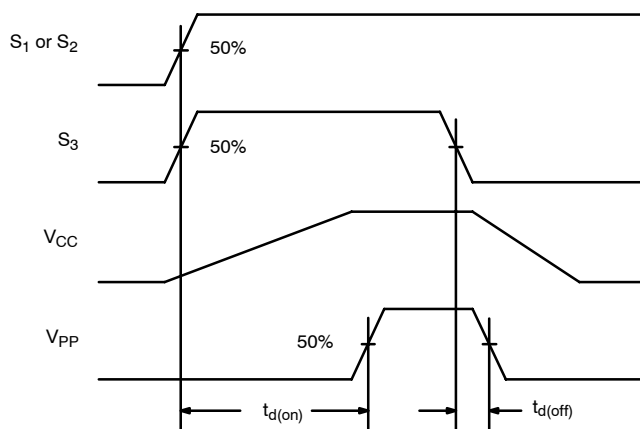
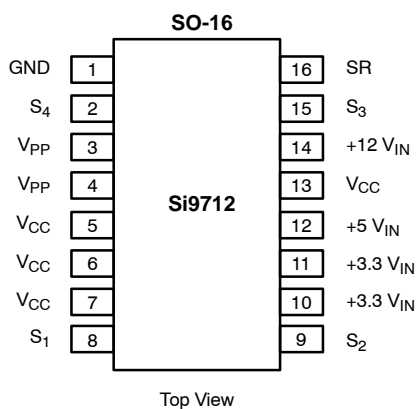

FIGURE 3. Delay from S_1 or S_2 to V_{PP} Power-up

PIN CONFIGURATION AND DESCRIPTION



Note: Pins 5, 6, 7, and 13 must be connected in the PCB for correct operation.

Pin Number	Function	Description
1.	GND	Ground connection.
2	S_4	Control input for selecting +3.3 V_{IN} to V_{CC} . The PC Card terminology for this pin is V_{CC_EN0} .
3, 4	V_{PP}	Program and peripheral voltage to PC Card slot.
5, 6, 7, 13	V_{CC}	Supply voltage to slot.
8	S_1	Control input for selecting +12 V_{IN} to V_{PP} . The PC Card terminology for this pin is V_{PP_EN1} .
9	S_2	Control input for selecting V_{CC} to V_{PP} . The PC Card terminology for this pin is V_{PP_EN0} .
10, 11	+3.3 V_{IN}	+3.3-V supply.
12	+5 V_{IN}	+5-V supply.
14	+12 V_{IN}	+12-V supply.
15	S_3	Control input for selecting +5 V_{IN} to V_{CC} . The PC Card terminology for this pin is V_{CC_EN1} .
16	SR	Slew rate control pin, capacitor to GND defines programmable ramp time.

ORDERING INFORMATION		
Part Number	Temperature Range	Package
Si9712DY	-40 to 85°C	SOIC-16
Si9712DY-T1		
Si9712DY-T1—E3		

TRUTH TABLE ^b									
S ₁	S ₂	S ₃	S ₄	Switch 1 ^a	Switch 2 ^a	Switch 3	Switch 4	Switch 5	Switch 6
0	0	0	0	Off	Off	Off	Off	On	On
0	0	0	1	Off	Off	Off	On	On	Off
0	0	1	0	Off	Off	On	Off	On	Off
0	0	1	1	Off	Off	Off	Off	On	On
0	1	0	0	Off	Off	Off	Off	On	On
0	1	0	1	Off	On	Off	On	Off	Off
0	1	1	0	Off	On	On	Off	Off	Off
0	1	1	1	Off	Off	Off	Off	On	On
1	0	0	0	Off	Off	Off	Off	On	On
1	0	0	1	On	Off	Off	On	Off	Off
1	0	1	0	On	Off	On	Off	Off	Off
1	0	1	1	Off	Off	Off	Off	On	On
1	1	0	0	Off	Off	Off	Off	On	On
1	1	0	1	On	Off	Off	On	Off	Off
1	1	1	0	On	Off	On	Off	Off	Off
1	1	1	1	Off	Off	Off	Off	On	On

Notes

- a. Turn on of switch 1 and 2 are internally delayed until after V_{CC} is valid. See Figure 3.
- b. Shaded lines are error conditions for PC Card applications, however, switches default to the states shown.

TIMING DIAGRAM

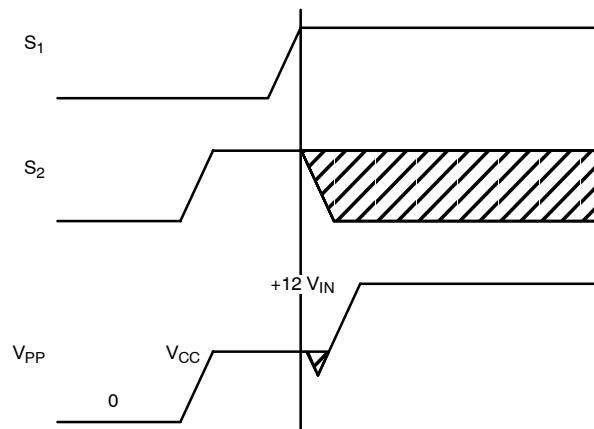
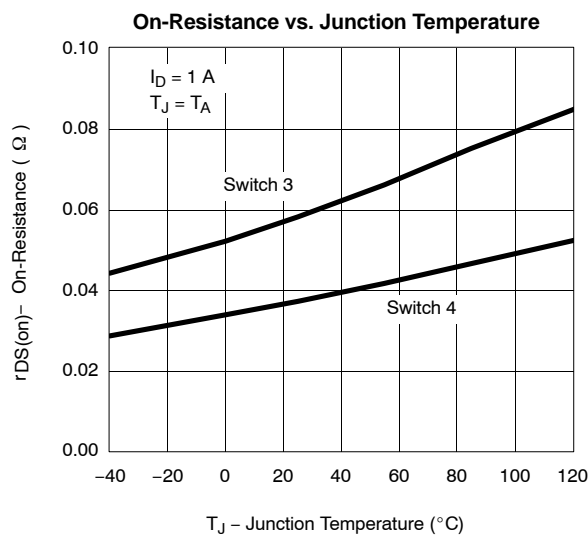
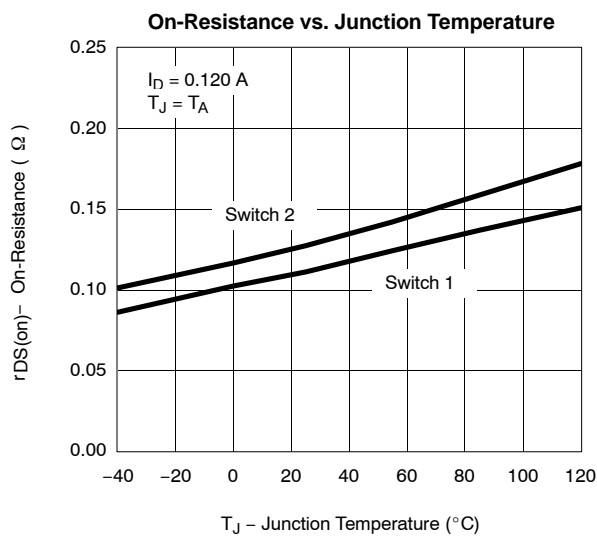
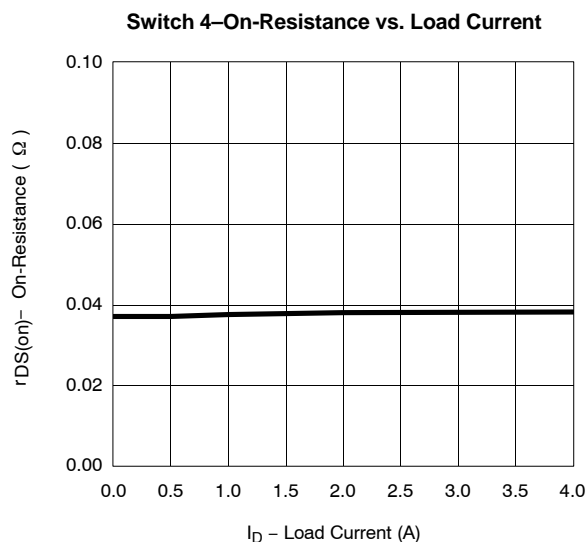
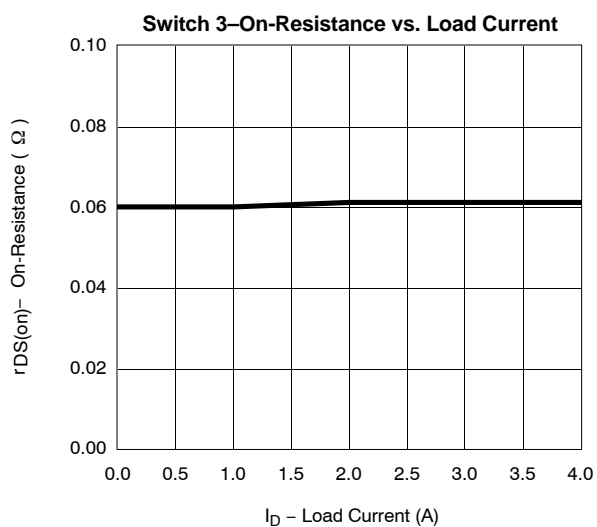
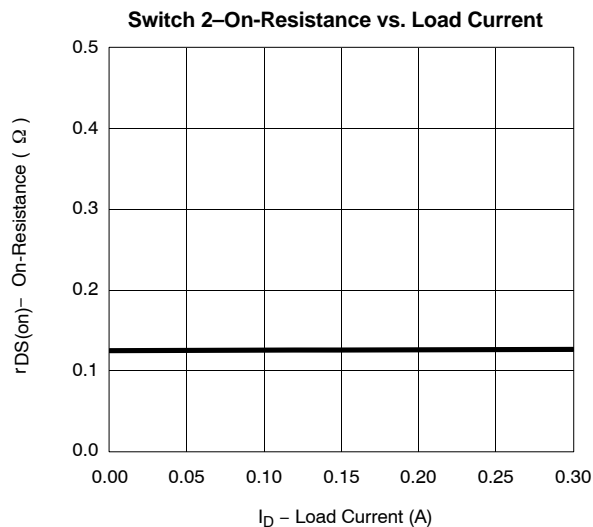
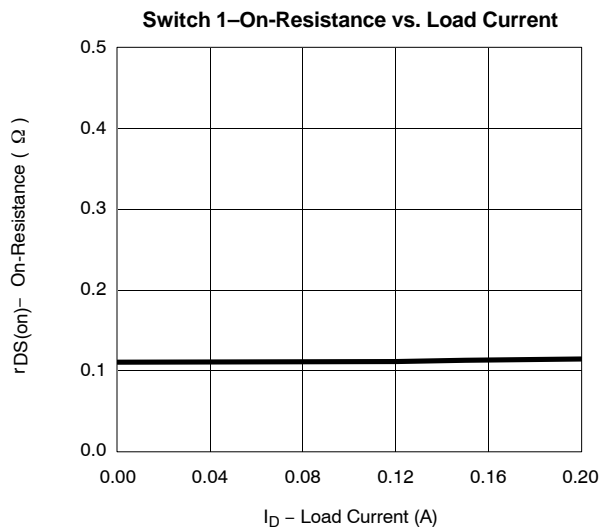

FIGURE 4. Break-Before-Make of SW₁ and SW₂



TYPICAL CHARACTERISTICS (25°C UNLESS OTHERWISE NOTED)





TYPICAL CHARACTERISTICS (25°C UNLESS OTHERWISE NOTED)

Rise Time vs. SR Capacitor Value

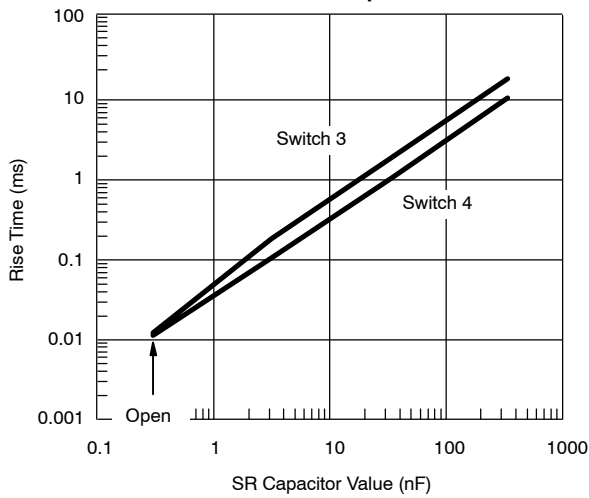

Fall Time vs. SR Capacitor Value

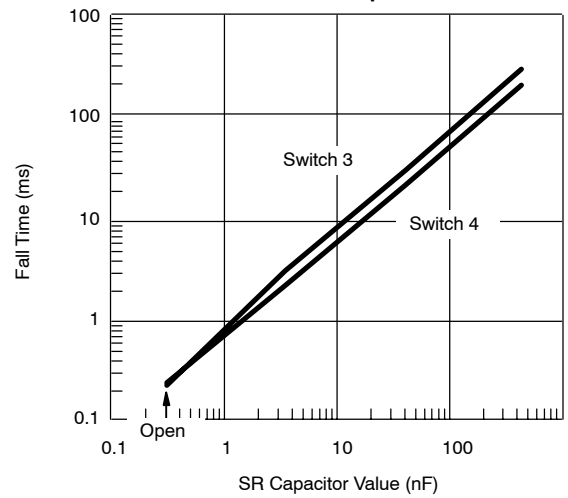

**Switch 3
Rise Time vs. Load Capacitance**

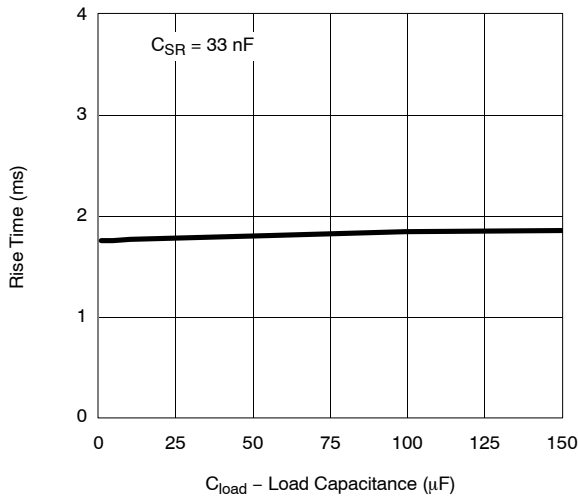

**Switch 3
Fall Time vs. Load Capacitance**

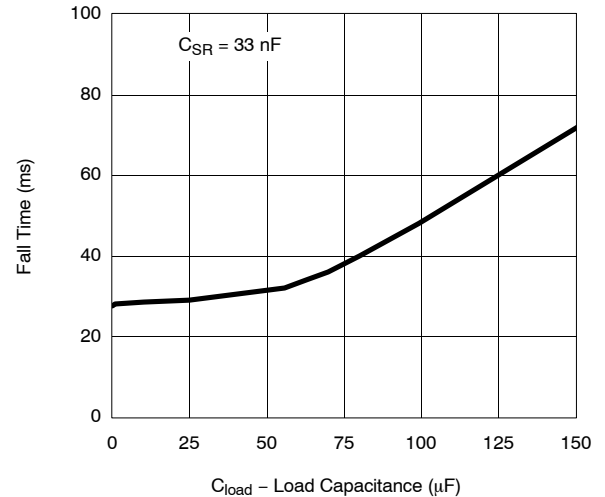

**Switch 4
Rise Time vs. Load Capacitance**

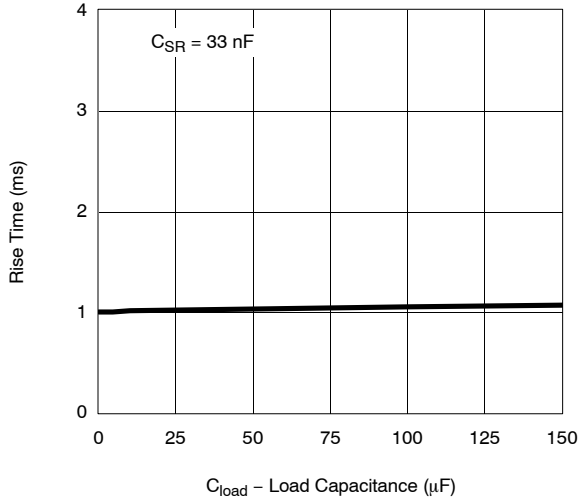

**Switch 4
Fall Time vs. Load Capacitance**

