

TOSHIBA CMOS DIGITAL INTEGRATED CIRCUIT SILICON MONOLITHIC

**TC74VCXR162500FT****LOW-VOLTAGE 18-BIT UNIVERSAL BUS TRANSCEIVER  
WITH 3.6 V TOLERANT INPUTS AND OUTPUTS**

The TC74VCXR162500FT is a high performance CMOS 18-bit UNIVERSAL BUS TRANSCEIVER. Designed for use in 1.8, 2.5 or 3.3 Volt systems, it achieves high speed operation while maintaining the CMOS low power dissipation.

It is also designed with over voltage tolerant inputs and outputs up to 3.6 V.

Data flow in each direction is controlled by output-enable ( $\overline{OEAB}$  and  $\overline{OEBA}$ ), latch-enable (LEAB and LEBA), and clock ( $\overline{CKAB}$  and  $\overline{CKBA}$ ) inputs. For A-to-B data flow, the device operates in the transparent mode when LEAB is high. When LEAB is low, the A data is latched if  $\overline{CKAB}$  is held at a high or low logic level. If LEAB is low, the A bus data is stored in the latch / flip-flop on the high-to-low transition of  $\overline{CKAB}$ .

Data flow for B to A is similar to that of A to B but uses  $\overline{OEBA}$ , LEBA, and  $\overline{CKBA}$ . When the  $\overline{OE}$  input is high, the outputs are in a high impedance state. This device is designed to be used with 3-state memory address drivers, etc.

The 26- $\Omega$  series resistor helps reducing output overshoot and undershoot without external resistor. All inputs are equipped with protection circuits against static discharge.

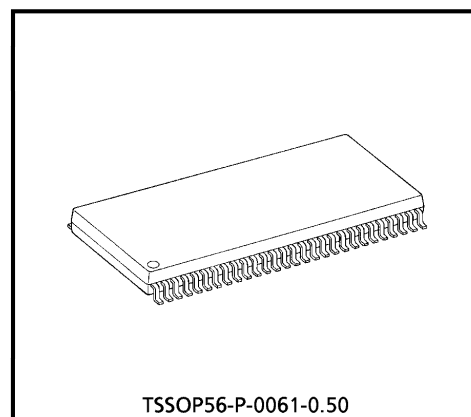

Weight : 0.25 g (Typ.)

**FEATURES**

- 26- $\Omega$  Series Resistors on Outputs.
- Low Voltage Operation :  $V_{CC} = 1.8\sim 3.6\text{ V}$
- High Speed Operation :  $t_{pd} = 3.8\text{ ns (max)}$  at  $V_{CC} = 3.0\sim 3.6\text{ V}$   
                                   :  $t_{pd} = 4.9\text{ ns (max)}$  at  $V_{CC} = 2.3\sim 2.7\text{ V}$   
                                   :  $t_{pd} = 9.8\text{ ns (max)}$  at  $V_{CC} = 1.8\text{ V}$
- 3.6 V Tolerant inputs and outputs.
- Output Current :  $I_{OH}/I_{OL} = \pm 12\text{ mA (min)}$  at  $V_{CC} = 3.0\text{ V}$   
                           :  $I_{OH}/I_{OL} = \pm 8\text{ mA (min)}$  at  $V_{CC} = 2.3\text{ V}$   
                           :  $I_{OH}/I_{OL} = \pm 4\text{ mA (min)}$  at  $V_{CC} = 1.8\text{ V}$
- Latch-up Performance :  $\pm 300\text{ mA}$
- ESD Performance : Human Body Model  $> \pm 2000\text{ V}$   
                           : Machine Model  $> \pm 200\text{ V}$
- Package : TSSOP (Thin Shrink Small Outline Package)
- Bidirectional interface between 2.5 V and 3.3 V signals.
- Power Down Protection is provided on all inputs and outputs.
- Supports live insertion / withdrawal (Note 3)

980910EBA2

● TOSHIBA is continually working to improve the quality and the reliability of its products. Nevertheless, semiconductor devices in general can malfunction or fail due to their inherent electrical sensitivity and vulnerability to physical stress. It is the responsibility of the buyer, when utilizing TOSHIBA products, to observe standards of safety, and to avoid situations in which a malfunction or failure of a TOSHIBA product could cause loss of human life, bodily injury or damage to property. In developing your designs, please ensure that TOSHIBA products are used within specified operating ranges as set forth in the most recent products specifications. Also, please keep in mind the precautions and conditions set forth in the TOSHIBA Semiconductor Reliability Handbook.

- (Note 1) : Do not apply a signal to any bus terminal when it is in the output mode. Damage may result.
- (Note 2) : All floating (high impedance) bus terminal must have their input level fixed by means of pull up or pull down resistors.
- (Note 3) : To ensure the high-impedance state during power up or power down,  $\overline{OE}$  should be tied to  $V_{CC}$  through a pullup resistor; the minimum value of the resistor is determined by the current-sourcing capability of the driver.

**PIN ASSIGNMENT**

**SYMBOL**

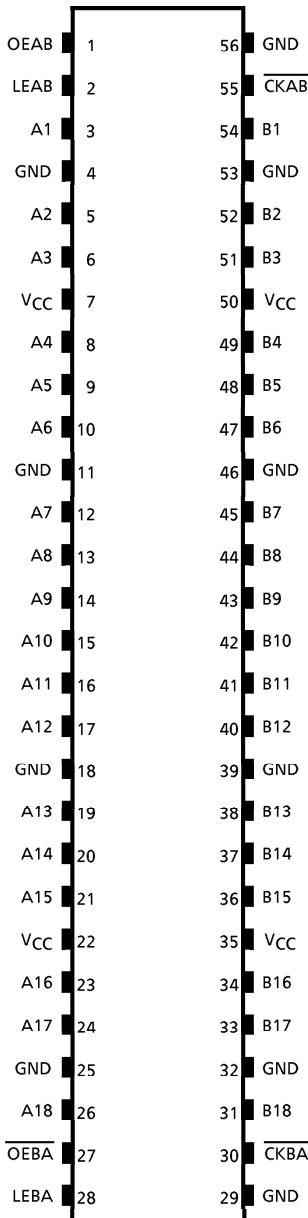

(TOP VIEW)

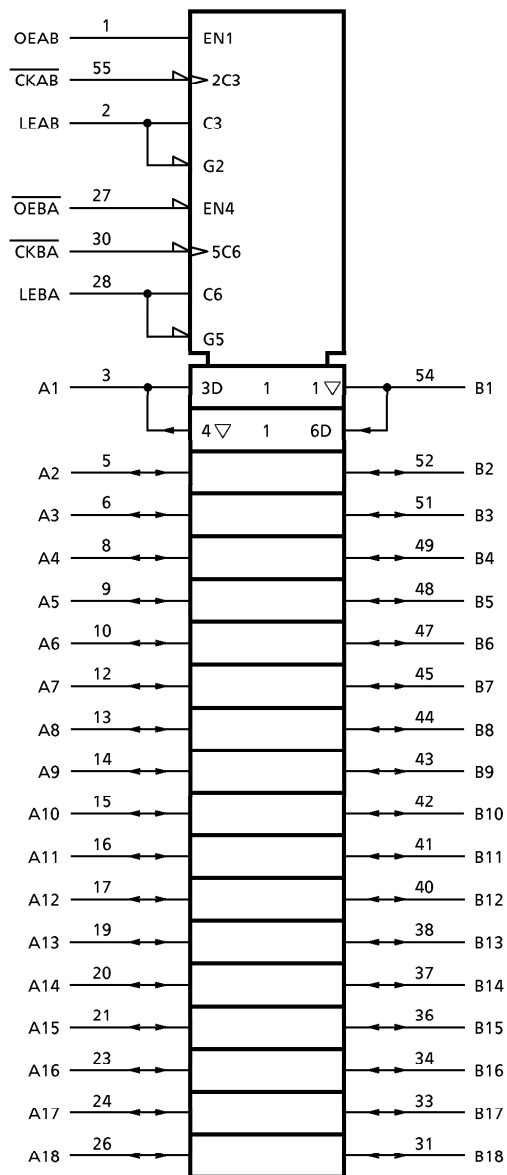

980910EBA2'

- The products described in this document are subject to the foreign exchange and foreign trade laws.
- The information contained herein is presented only as a guide for the applications of our products. No responsibility is assumed by TOSHIBA CORPORATION for any infringements of intellectual property or other rights of the third parties which may result from its use. No license is granted by implication or otherwise under any intellectual property or other rights of TOSHIBA CORPORATION or others.
- The information contained herein is subject to change without notice.

**TRUTH TABLE \***

INPUTS				OUTPUTS
OEAB	LEAB	CKAB	A	B
L	X	X	X	Z
H	H	X	L	L
H	H	X	H	H
H	L	$\downarrow$	L	L
H	L	$\downarrow$	H	H
H	L	H	X	B0**
H	L	L	X	B0**

\* A-to-B data flow is shown: B-to-A flow is similar but uses  $\overline{OEBA}$ , LEBA, and  $\overline{CKBA}$ .

\*\* Output level before the indicated steady-state input conditions were established, provided that  $\overline{CKAB}$  was low or high before LEAB went low.

**SYSTEM DIAGRAM**

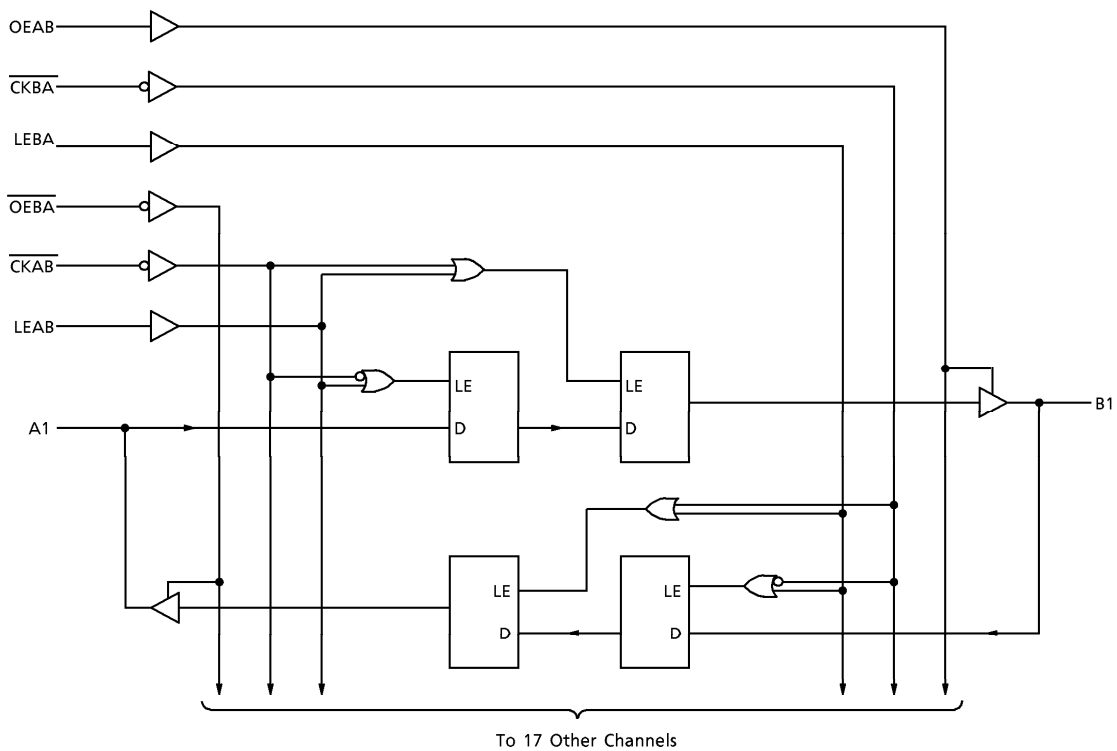

## MAXIMUM RATINGS

PARAMETER	SYMBOL	RATING	UNIT
Power Supply Voltage	$V_{CC}$	-0.5~4.6	V
DC Input Voltage (OEAB, $\overline{OEBA}$ , LEAB, LEBA, $\overline{CKAB}$ , $\overline{CKBA}$ )	$V_{IN}$	-0.5~4.6	V
DC Bus I/O Voltage	$V_{I/O}$	-0.5~4.6 (Note 1)	V
		-0.5~ $V_{CC} + 0.5$ (Note 2)	
Input Diode Current	$I_{IK}$	-50	mA
Output Diode Current	$I_{OK}$	$\pm 50$ (Note 3)	mA
DC Output Current	$I_{OUT}$	$\pm 50$	mA
Power Dissipation	$P_D$	400	mW
DC $V_{CC}$ /Ground Current Per Supply Pin	$I_{CC}/I_{GND}$	$\pm 100$	mA
Storage Temperature	$T_{stg}$	-65~150	$^{\circ}C$

(Note 1) : Off-State

(Note 2) : High or Low State.  $I_{OUT}$  absolute maximum rating must be observed.

(Note 3) :  $V_{OUT} < GND$ ,  $V_{OUT} > V_{CC}$

## RECOMMENDED OPERATING RANGE

PARAMETER	SYMBOL	RATING	UNIT
Supply Voltage	$V_{CC}$	1.8~3.6	V
		1.2~3.6 (Note 4)	
Input Voltage (OEAB, $\overline{OEBA}$ , LEAB, LEBA, $\overline{CKAB}$ , $\overline{CKBA}$ )	$V_{IN}$	-0.3~3.6	V
Bus I/O Voltage	$V_{I/O}$	0~3.6 (Note 5)	V
		0~ $V_{CC}$ (Note 6)	
Output Current	$I_{OH}/I_{OL}$	$\pm 12$ (Note 7)	mA
		$\pm 8$ (Note 8)	
		$\pm 4$ (Note 9)	
Operating Temperature	$T_{opr}$	-40~85	$^{\circ}C$
Input Rise And Fall Time	$dt/dv$	0~10 (Note 10)	ns/V

(Note 4) : Data Retention Only

(Note 5) : Off-State

(Note 6) : High or Low State

(Note 7) :  $V_{CC} = 3.0\sim 3.6$  V

(Note 8) :  $V_{CC} = 2.3\sim 2.7$  V

(Note 9) :  $V_{CC} = 1.8$  V

(Note 10) :  $V_{IN} = 0.8\sim 2.0$  V,  $V_{CC} = 3.0$  V

**ELECTRICAL CHARACTERISTICS**

DC characteristics (Ta = -40~85°C, 2.7 V < VCC ≤ 3.6 V)

PARAMETER		SYMBOL	TEST CONDITION	VCC (V)	MIN	MAX	UNIT	
Input Voltage	"H" Level	V <sub>IH</sub>		2.7~3.6	2.0	—	V	
	"L" Level	V <sub>IL</sub>		2.7~3.6	—	0.8		
Output Voltage	"H" Level	V <sub>OH</sub>	V <sub>IN</sub> = V <sub>IH</sub> or V <sub>IL</sub>	I <sub>OH</sub> = -100 μA	2.7~3.6	V <sub>CC</sub> - 0.2	—	V
				I <sub>OH</sub> = -6 mA	2.7	2.2	—	
				I <sub>OH</sub> = -8 mA	3.0	2.4	—	
				I <sub>OH</sub> = -12 mA	3.0	2.2	—	
	"L" Level	V <sub>OL</sub>	V <sub>IN</sub> = V <sub>IH</sub> or V <sub>IL</sub>	I <sub>OL</sub> = 100 μA	2.7~3.6	—	0.2	
				I <sub>OL</sub> = 6 mA	2.7	—	0.4	
				I <sub>OL</sub> = 8 mA	3.0	—	0.55	
				I <sub>OL</sub> = 12 mA	3.0	—	0.8	
Input Leakage Current		I <sub>IN</sub>	V <sub>IN</sub> = 0~3.6 V	2.7~3.6	—	± 5.0	μA	
3-State Output Off-State Current		I <sub>OZ</sub>	V <sub>IN</sub> = V <sub>IH</sub> or V <sub>IL</sub> V <sub>OUT</sub> = 0~3.6 V	2.7~3.6	—	± 10.0	μA	
Power Off Leakage Current		I <sub>OFF</sub>	V <sub>IN</sub> , V <sub>OUT</sub> = 0~3.6 V	0	—	10.0	μA	
Quiescent Supply Current		I <sub>CC</sub>	V <sub>IN</sub> = V <sub>CC</sub> or GND	2.7~3.6	—	20.0	μA	
			V <sub>CC</sub> ≤ (V <sub>IN</sub> , V <sub>OUT</sub> ) ≤ 3.6 V	2.7~3.6	—	± 20.0		
Increase In I <sub>CC</sub> Per Input		ΔI <sub>CC</sub>	V <sub>IH</sub> = V <sub>CC</sub> - 0.6 V	2.7~3.6	—	750	μA	

**ELECTRICAL CHARACTERISTICS**

DC characteristics (Ta = -40~85°C, 2.3 V ≤ VCC ≤ 2.7 V)

PARAMETER		SYMBOL	TEST CONDITION	VCC (V)	MIN	MAX	UNIT	
Input Voltage	"H" Level	V <sub>IH</sub>		2.3~2.7	1.6	—	V	
	"L" Level	V <sub>IL</sub>		2.3~2.7	—	0.7		
Output Voltage	"H" Level	V <sub>OH</sub>	V <sub>IN</sub> = V <sub>IH</sub> or V <sub>IL</sub>	I <sub>OH</sub> = -100 μA	2.3~2.7	V <sub>CC</sub> - 0.2	—	V
				I <sub>OH</sub> = -4 mA	2.3	2.0	—	
				I <sub>OH</sub> = -6 mA	2.3	1.8	—	
				I <sub>OH</sub> = -8 mA	2.3	1.7	—	
	"L" Level	V <sub>OL</sub>	V <sub>IN</sub> = V <sub>IH</sub> or V <sub>IL</sub>	I <sub>OL</sub> = 100 μA	2.3~2.7	—	0.2	
				I <sub>OL</sub> = 6 mA	2.3	—	0.4	
				I <sub>OL</sub> = 8 mA	2.3	—	0.6	
Input Leakage Current		I <sub>IN</sub>	V <sub>IN</sub> = 0~3.6 V	2.3~2.7	—	± 5.0	μA	
3-State Output Off-State Current		I <sub>OZ</sub>	V <sub>IN</sub> = V <sub>IH</sub> or V <sub>IL</sub> V <sub>OUT</sub> = 0~3.6 V	2.3~2.7	—	± 10.0	μA	
Power Off Leakage Current		I <sub>OFF</sub>	V <sub>IN</sub> , V <sub>OUT</sub> = 0~3.6 V	0	—	10.0	μA	
Quiescent Supply Current		I <sub>CC</sub>	V <sub>IN</sub> = V <sub>CC</sub> or GND	2.3~2.7	—	20.0	μA	
			V <sub>CC</sub> ≤ (V <sub>IN</sub> , V <sub>OUT</sub> ) ≤ 3.6 V	2.3~2.7	—	± 20.0		

## ELECTRICAL CHARACTERISTICS

DC characteristics ( $T_a = -40\sim 85^\circ\text{C}$ ,  $1.8\text{ V} \leq V_{CC} < 2.3\text{ V}$ )

PARAMETER		SYMBOL	TEST CONDITION		V <sub>CC</sub> (V)	MIN	MAX	UNIT
					1.8~2.3			
Input Voltage	"H" Level	V <sub>IH</sub>			1.8~2.3	$0.7 \times V_{CC}$	—	V
	"L" Level	V <sub>IL</sub>			1.8~2.3	—	$0.2 \times V_{CC}$	
Output Voltage	"H" Level	V <sub>OH</sub>	V <sub>IN</sub> = V <sub>IH</sub> or V <sub>IL</sub>	I <sub>OH</sub> = -100 μA	1.8	V <sub>CC</sub> - 0.2	—	V
				I <sub>OH</sub> = -4 mA	1.8	1.4	—	
	"L" Level	V <sub>OL</sub>	V <sub>IN</sub> = V <sub>IH</sub> or V <sub>IL</sub>	I <sub>OL</sub> = 100 μA	1.8	—	0.2	
				I <sub>OL</sub> = 4 mA	1.8	—	0.3	
Input Leakage Current		I <sub>IN</sub>	V <sub>IN</sub> = 0~3.6 V		1.8	—	± 5.0	μA
3-State Output Off-State Current		I <sub>OZ</sub>	V <sub>IN</sub> = V <sub>IH</sub> or V <sub>IL</sub> V <sub>OUT</sub> = 0~3.6 V		1.8	—	± 10.0	μA
Power Off Leakage Current		I <sub>OFF</sub>	V <sub>IN</sub> , V <sub>OUT</sub> = 0~3.6 V		0	—	10.0	μA
Quiescent Supply Current		I <sub>CC</sub>	V <sub>IN</sub> = V <sub>CC</sub> or GND		1.8	—	20.0	μA
			V <sub>CC</sub> ≤ (V <sub>IN</sub> , V <sub>OUT</sub> ) ≤ 3.6 V		1.8	—	± 20.0	

AC characteristics (Ta = -40~85°C, Input tr = tf = 2.0 ns, CL = 30 pF, RL = 500 Ω)

PARAMETER	SYMBOL	TEST CONDITION	VCC (V)	MIN	MAX	UNIT
Maximum Clock Frequency	fMAX	(Fig.1, 3)	1.8	100	—	MHz
			2.5 ± 0.2	200	—	
			3.3 ± 0.3	250	—	
Propagation Delay Time (An, Bn-Bn, An)	tpLH tpHL	(Fig.1, 2)	1.8	1.5	9.8	ns
			2.5 ± 0.2	0.8	4.9	
			3.3 ± 0.3	0.6	3.8	
Propagation Delay Time (CKAB, CLKBA-Bn, An)	tpLH tpHL	(Fig.1, 3)	1.8	1.5	9.8	ns
			2.5 ± 0.2	0.8	6.7	
			3.3 ± 0.3	0.6	5.1	
Propagation Delay Time (LEAB, LEBA-Bn, An)	tpLH tpHL	(Fig.1, 4)	1.8	1.5	9.8	ns
			2.5 ± 0.2	0.8	6.3	
			3.3 ± 0.3	0.6	4.7	
Output Enable Time (OEAB, OEBA-Bn, An)	tpZL tpZH	(Fig.1, 5, 6)	1.8	1.5	9.8	ns
			2.5 ± 0.2	0.8	5.9	
			3.3 ± 0.3	0.6	4.3	
Output Disable Time (OEAB, OEBA-Bn, An)	tpLZ tpHZ	(Fig.1, 5, 6)	1.8	1.5	8.8	ns
			2.5 ± 0.2	0.8	4.9	
			3.3 ± 0.3	0.6	4.3	
Minimum Pulse Width	tw (H) tw (L)	(Fig.1, 3, 4)	1.8	4.0	—	ns
			2.5 ± 0.2	1.5	—	
			3.3 ± 0.3	1.5	—	
Minimum Set-up Time	ts	(Fig.1, 3, 4)	1.8	2.5	—	ns
			2.5 ± 0.2	1.5	—	
			3.3 ± 0.3	1.5	—	
Minimum Hold Time	th	(Fig.1, 3, 4)	1.8	1.0	—	ns
			2.5 ± 0.2	1.0	—	
			3.3 ± 0.3	1.0	—	
Output to Output Skew	tosLH tosHL	(Note 11)	1.8	—	0.5	ns
			2.5 ± 0.2	—	0.5	
			3.3 ± 0.3	—	0.5	

For CL = 50 pF, add approximately 300 ps to the AC maximum specification.

(Note 11) : Parameter guaranteed by design.

$$(tosLH = |tpLHm - tpLHn|, tosHL = |tpHLm - tpHLn|)$$

Dynamic switching characteristics (Ta = 25°C, Input t<sub>r</sub> = t<sub>f</sub> = 2.0 ns, C<sub>L</sub> = 30 pF)

PARAMETER	SYMBOL	TEST CONDITION	V <sub>CC</sub> (V)	TYP.	UNIT
Quiet Output Maximum Dynamic V <sub>OL</sub>	V <sub>OLP</sub>	V <sub>IH</sub> = 1.8 V, V <sub>IL</sub> = 0 V (Note 12)	1.8	0.15	V
		V <sub>IH</sub> = 2.5 V, V <sub>IL</sub> = 0 V (Note 12)	2.5	0.25	
		V <sub>IH</sub> = 3.3 V, V <sub>IL</sub> = 0 V (Note 12)	3.3	0.35	
Quiet Output Minimum Dynamic V <sub>OL</sub>	V <sub>OLV</sub>	V <sub>IH</sub> = 1.8 V, V <sub>IL</sub> = 0 V (Note 12)	1.8	-0.15	V
		V <sub>IH</sub> = 2.5 V, V <sub>IL</sub> = 0 V (Note 12)	2.5	-0.25	
		V <sub>IH</sub> = 3.3 V, V <sub>IL</sub> = 0 V (Note 12)	3.3	-0.35	
Quiet Output Minimum Dynamic V <sub>OH</sub>	V <sub>OHV</sub>	V <sub>IH</sub> = 1.8 V, V <sub>IL</sub> = 0 V (Note 12)	1.8	1.55	V
		V <sub>IH</sub> = 2.5 V, V <sub>IL</sub> = 0 V (Note 12)	2.5	2.05	
		V <sub>IH</sub> = 3.3 V, V <sub>IL</sub> = 0 V (Note 12)	3.3	2.65	

(Note 12) : Parameter guaranteed by design.

Capacitive characteristics (Ta = 25°C)

PARAMETER	SYMBOL	TEST CONDITION	V <sub>CC</sub> (V)	TYP.	UNIT
Input Capacitance	C <sub>IN</sub>	—	1.8, 2.5, 3.3	6	pF
Bus I/O Capacitance	C <sub>I/O</sub>		1.8, 2.5, 3.3	7	pF
Power Dissipation Capacitance	C <sub>PD</sub>	f <sub>IN</sub> = 10 MHz (Note 13)	1.8, 2.5, 3.3	20	pF

(Note 13) : C<sub>PD</sub> is defined as the value of the internal equivalent capacitance which is calculated from the operating current consumption without load.

Average operating current can be obtained by the equation :

$$I_{CC}(\text{opr.}) = C_{PD} \cdot V_{CC} \cdot f_{IN} + I_{CC} / 18 (\text{per bit})$$



**TEST CIRCUIT**

Fig.1

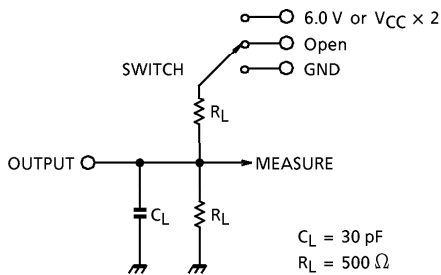

PARAMETER	SWITCH
$t_{pLH}, t_{pHL}$	Open
$t_{pLZ}, t_{pZL}$	6.0 V @ $V_{CC} = 3.3 \pm 0.3 \text{ V}$ $V_{CC} \times 2$ @ $V_{CC} = 2.5 \pm 0.2 \text{ V}$ @ $V_{CC} = 1.8 \text{ V}$
$t_{pHZ}, t_{pZH}$	GND

**AC WAVEFORM**

Fig.2  $t_{pLH}, t_{pHL}$

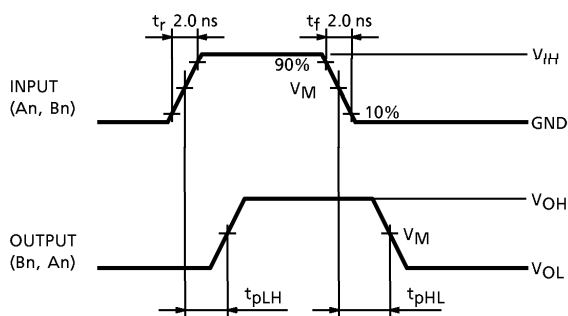

SYMBOL	$V_{CC}$		
	$3.3 \pm 0.3 \text{ V}$	$2.5 \pm 0.2 \text{ V}$	$1.8 \text{ V}$
$V_{IH}$	2.7 V	$V_{CC}$	$V_{CC}$
$V_M$	1.5 V	$V_{CC} / 2$	$V_{CC} / 2$
$V_X$	$V_{OL} + 0.3 \text{ V}$	$V_{OL} + 0.15 \text{ V}$	$V_{OL} + 0.15 \text{ V}$
$V_Y$	$V_{OH} - 0.3 \text{ V}$	$V_{OH} - 0.15 \text{ V}$	$V_{OH} - 0.15 \text{ V}$

Fig.3  $t_{pLH}, t_{pHL}, t_w, t_s, t_h$

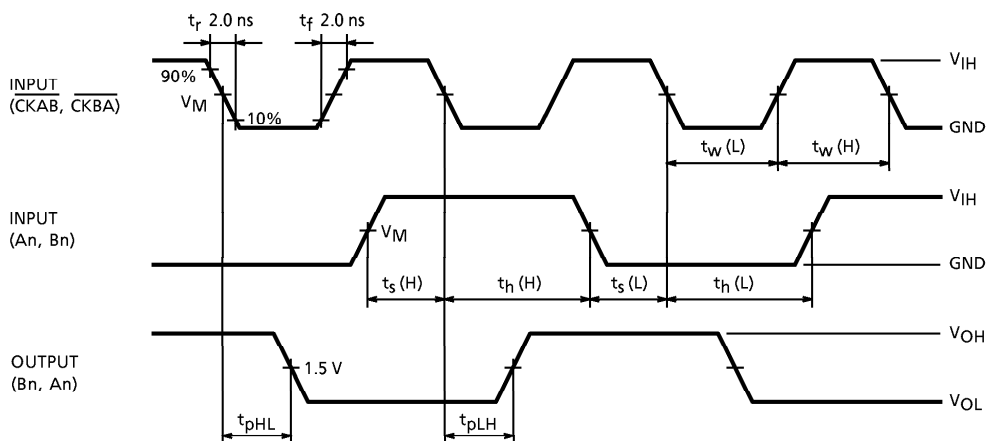

Fig.4  $t_{pLH}$ ,  $t_{pHL}$ ,  $t_w$ ,  $t_s$ ,  $t_h$

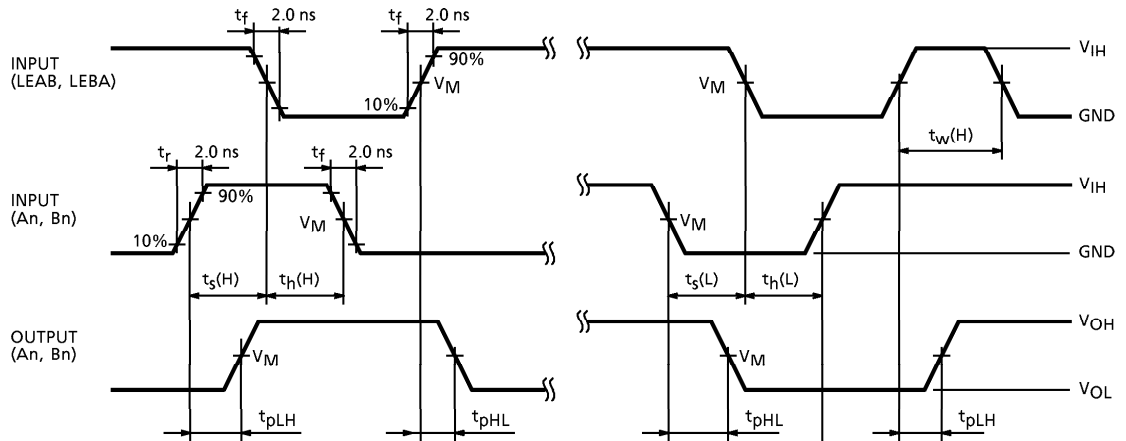

Fig.5  $t_{pLZ}$ ,  $t_{pHZ}$ ,  $t_{pZL}$ ,  $t_{pZH}$

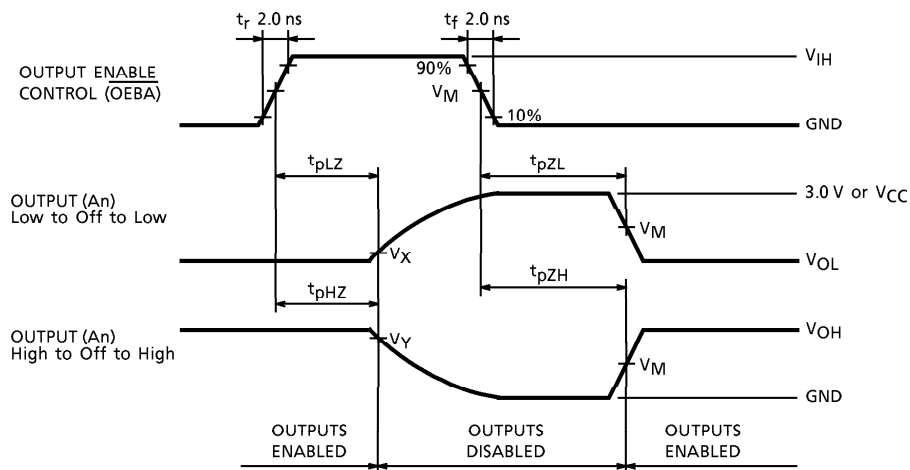
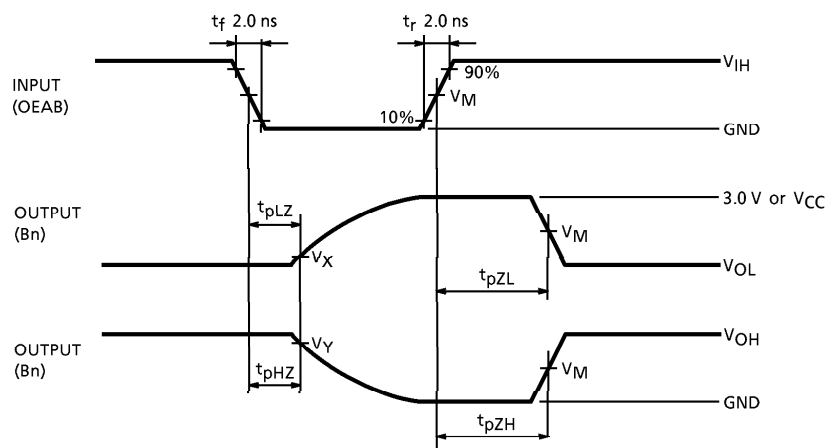

Fig.6  $t_{pLZ}$ ,  $t_{pHZ}$ ,  $t_{pZL}$ ,  $t_{pZH}$



OUTLINE DRAWING

TSSOP56-P-0061-0.50

Unit : mm

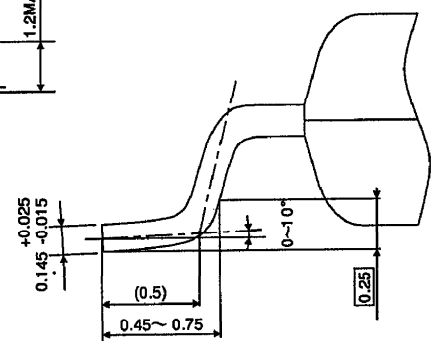
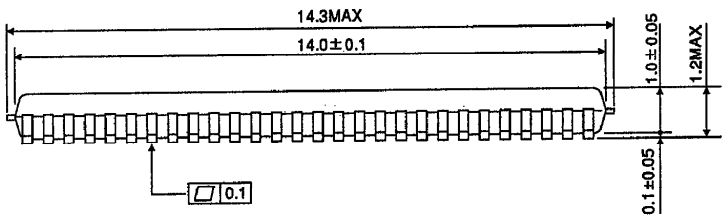
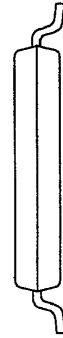
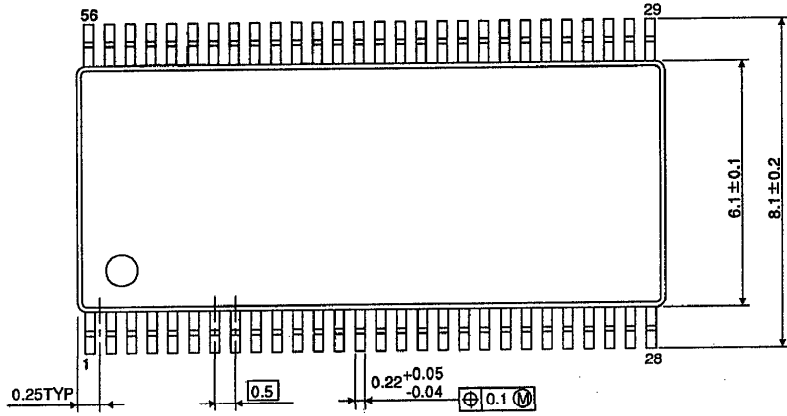

Weight : 0.25 g (Typ.)