

# GaAs IC 5 Bit Digital Attenuator 1 dB LSB DC–2 GHz



**AA260-85**  
(Previously AD260-85)\*

## Features

- Attenuation 1.0 dB Steps to 31 dB with High Accuracy
- Low DC Power Consumption
- Low Cost SSOP-20 Plastic Package

## SSOP-20

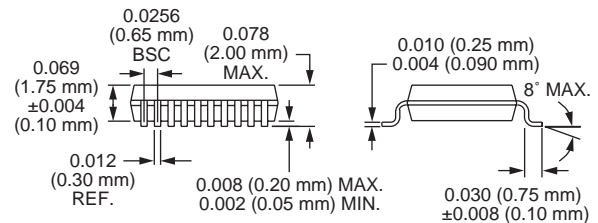
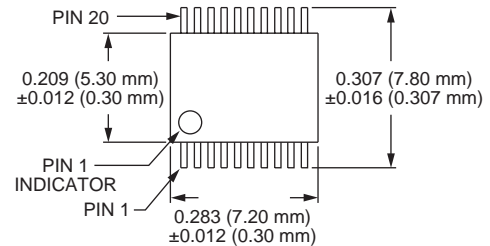

## Description

The AA260-85 is a 5 bit, GaAs IC FET digital attenuator in a low cost SSOP-20 package. This attenuator has an LSB of 1 dB and a total attenuation of 31 dB. The AA260-85 is particularly suited where high attenuation accuracy, low insertion loss and low intermodulation products are required. Typical applications include cellular radio, wireless data, wireless local loop and other gain level control circuits.

## Electrical Specifications at -40°C to +85°C (0, -5 V)

Parameter <sup>1</sup>	Condition	Frequency <sup>2</sup>	Min.	Typ.	Max.	Unit
Insertion Loss		DC–0.5 GHz		1.4	1.7	dB
		DC–1.0 GHz		1.6	2.0	dB
		DC–2.0 GHz		2.0	2.3	dB
Attenuation Range				31		dB
Attenuation Accuracy <sup>3</sup>		DC–1.0 GHz	± (0.2 + 3% of Attenuation Setting in dB)			dB
		DC–1.8 GHz	± (0.4 + 5% of Attenuation Setting in dB)			dB
		DC–2.0 GHz	± (0.5 + 6% of Attenuation Setting in dB)			dB
VSWR (I/O)		DC–2.0 GHz		1.4:1	1.7:1	
Switching Characteristics <sup>4</sup>	Rise, Fall (10/90% or 90%/10% RF) On, Off (50% CTL to 90%/10% RF) Video Feedthru			15		nS
				25		nS
				25		mV
Input Power for 1 dB Compression	V <sub>High</sub> = -5 V	0.5–2.0 GHz	+25	+29		dBm
		0.05 GHz	+18	+22		dBm
Intermodulation Intercept Point (IP3)	For Two-tone Input Power +5 dBm V <sub>High</sub> = -5 V	0.5–2.0 GHz	+42	+48		dBm
		0.05 GHz	+30	+36		dBm
Control Voltages	V <sub>Low</sub> = 0 to 0.2 V @ 20 μA Max. V <sub>High</sub> = -5 V @ 300 μA Max.					

1. All measurements made in a 50 Ω system, unless otherwise specified.  
2. DC = 300 kHz.

3. Attenuation referenced to insertion loss.  
4. Video feedthru measured with 1 ns risetime pulse and 500 MHz bandwidth.

\*Due to conflict with another company's product numbering system, Alpha's attenuator products starting with the letters "AD" are being changed to "AA".

**Typical Performance Data (0, -5 V)**

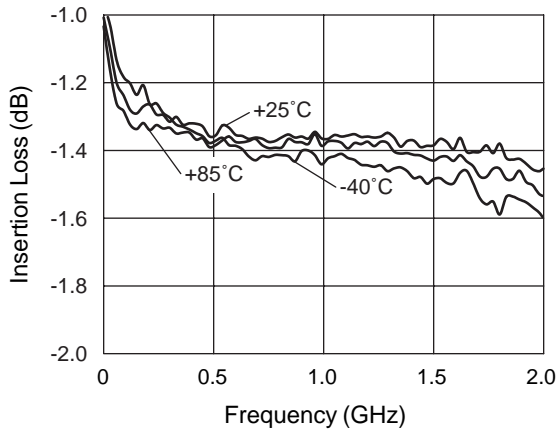

**Insertion Loss vs. Frequency**

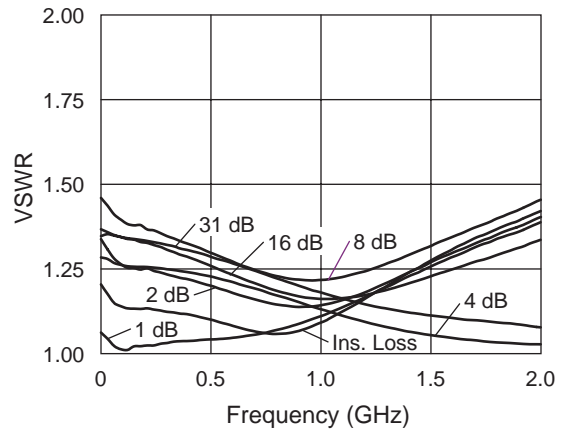

**VSWR vs. Frequency (25°C)**

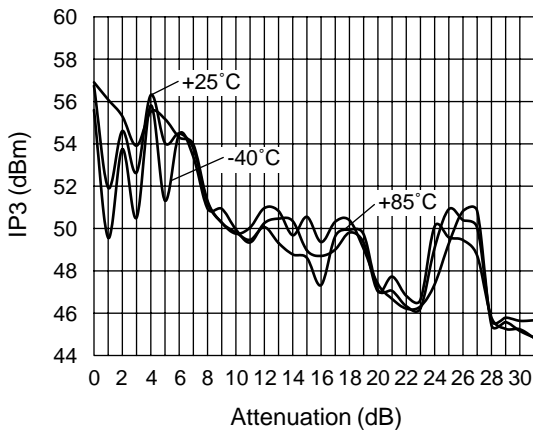

**IP3 vs. Attenuation and Temperature (500 MHz)**

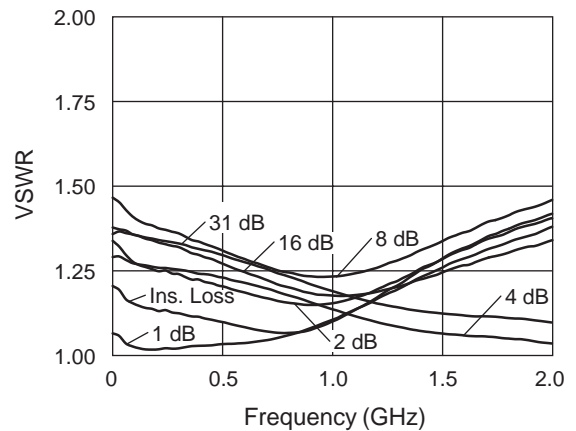

**VSWR vs. Frequency (85°C)**

**Compression Point vs. Attenuation, Voltage, and Temperature**

Attenuation State	Control Voltage (V)	Input Power @ 1 dB Compression		
		+25°C (dBm)	+85°C (dBm)	-40°C (dBm)
Ins. Loss	-5	29.6	29.4	29.9
1 dB	-5	30.1	29.8	30.5
2 dB	-5	29.5	29.4	29.6
4 dB	-5	34.0	32.7	32.9
8 dB	-5	29.5	29.3	29.8
16 dB	-5	28.6	28.6	28.3
31 dB	-5	32.1	31.6	31.3

Frequency = 0.5–2.0 GHz

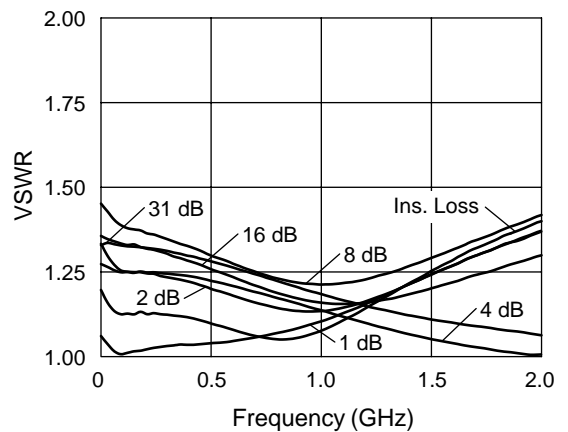

**VSWR vs. Frequency (-40°C)**

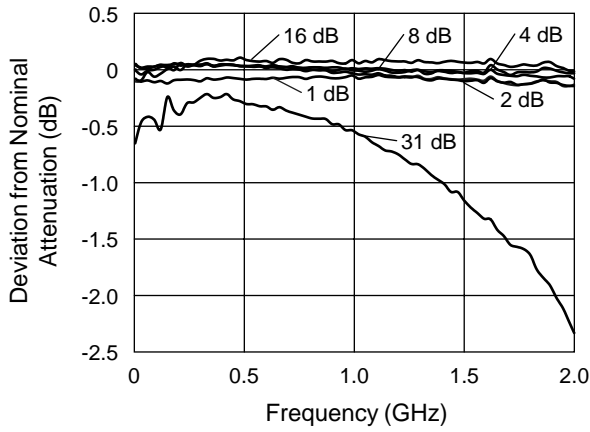

**Attenuation Accuracy vs. Frequency (25°C)**

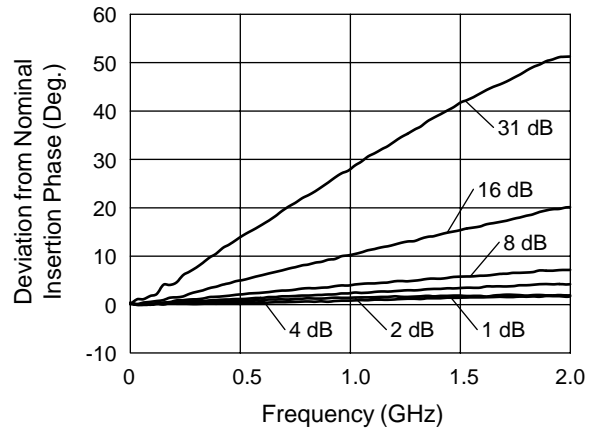

**Attenuation Phase Accuracy vs. Frequency (25°C)**

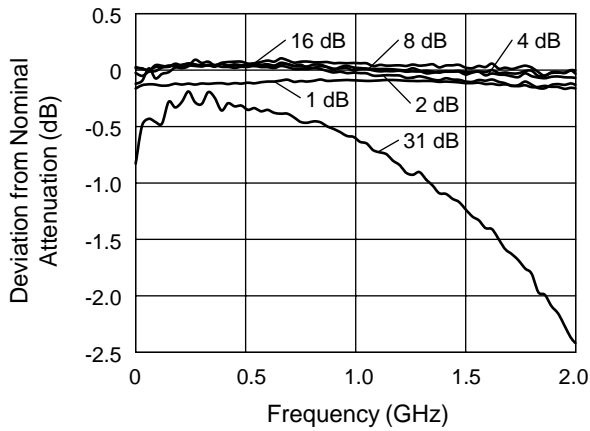

**Attenuation Accuracy vs. Frequency (85°C)**

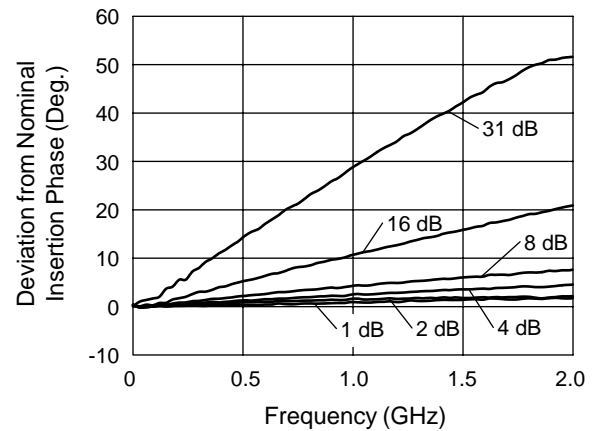

**Attenuation Phase Accuracy vs. Frequency (85°C)**

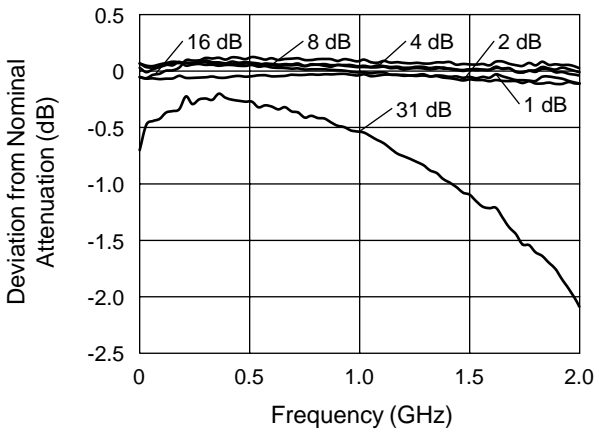

**Attenuation Accuracy vs. Frequency (-40°C)**

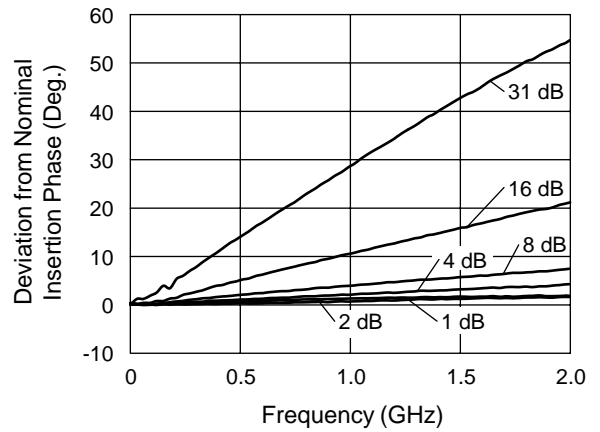

**Attenuation Phase Accuracy vs. Frequency (-40°C)**

Typical Performance Data (0, -3 V)

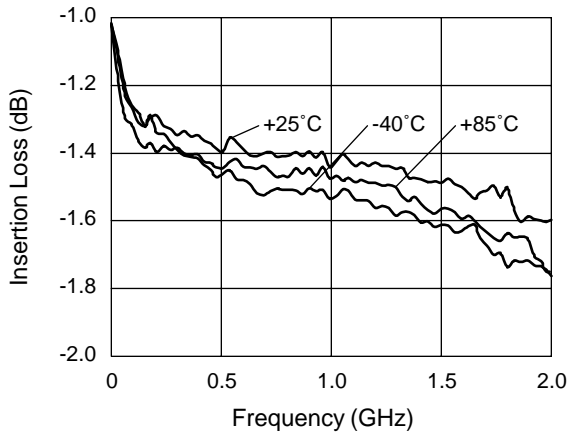

Insertion Loss vs. Frequency

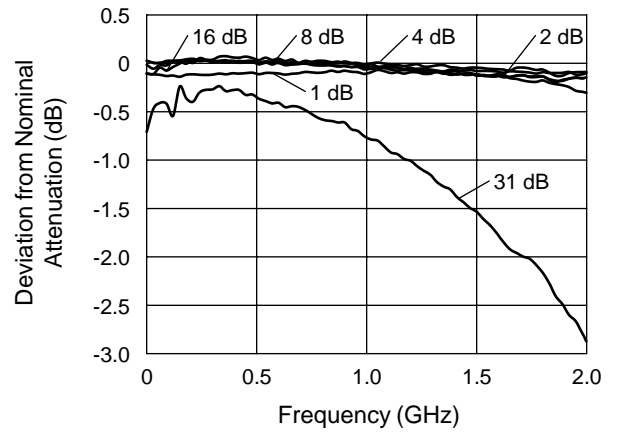

Attenuation Accuracy vs. Frequency (25°C)

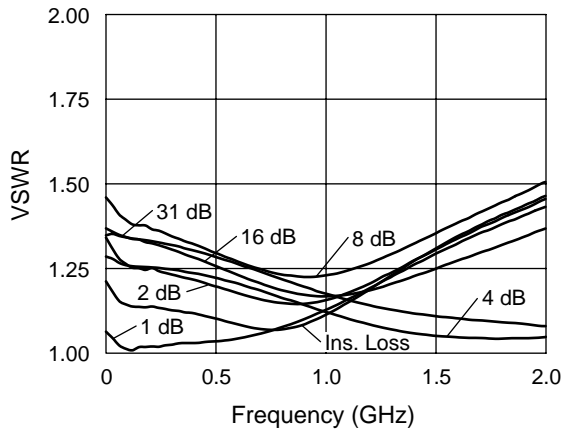

VSWR vs. Frequency (25°C)

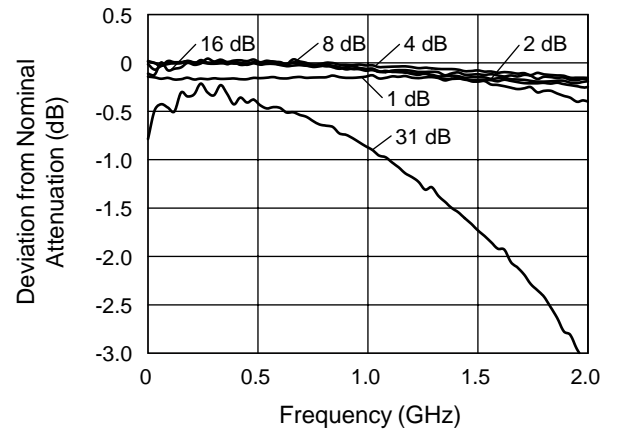

Attenuation Accuracy vs. Frequency (85°C)

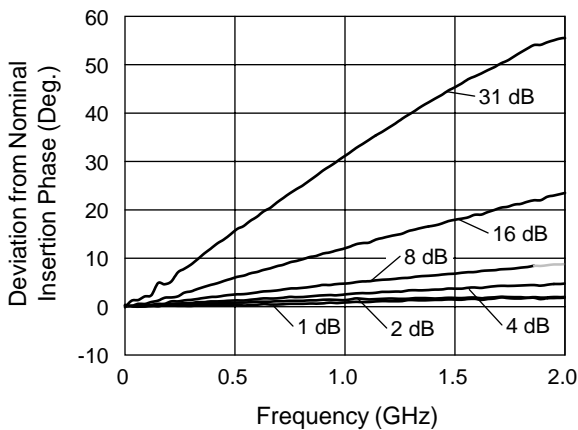

Attenuation Phase Accuracy vs. Frequency (25°C)

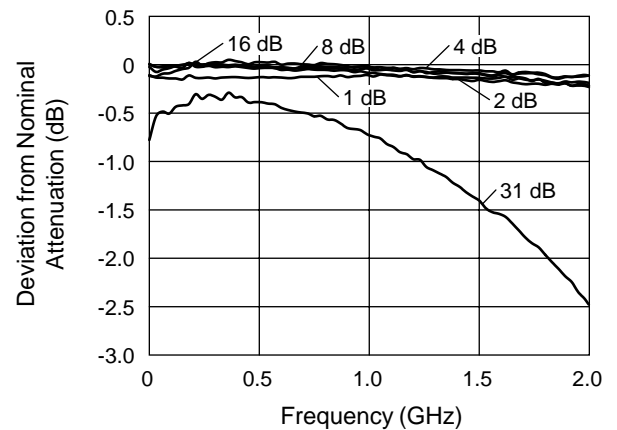

Attenuation Accuracy vs. Frequency (-40°C)

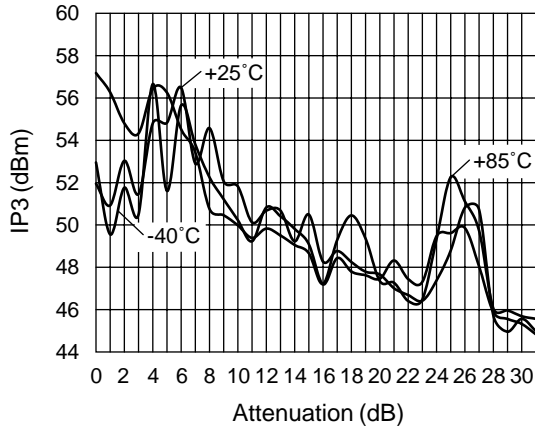

**IP3 vs. Attenuation and Temperature (500 MHz)**

**Compression Point vs. Attenuation, Voltage, and Temperature**

Attenuation State	Control Voltage (V)	Input Power @ 1 dB Compression		
		+25°C (dBm)	+85°C (dBm)	-40°C (dBm)
Ins. Loss	-3	24.8	24.7	24.7
1 dB	-3	26.2	25.9	25.7
2 dB	-3	24.7	24.5	24.6
4 dB	-3	29.3	28.7	29.0
8 dB	-3	32.3	31.7	32.3
16 dB	-3	21.6	21.2	21.7
31 dB	-3	24.5	24.4	24.9

Frequency = 0.5–2.0 GHz

**Truth Table**

V <sub>1</sub>	V <sub>2</sub>	V <sub>3</sub>	V <sub>4</sub>	V <sub>5</sub>	V <sub>6</sub>	V <sub>7</sub>	V <sub>8</sub>	V <sub>9</sub>	Attenuation J <sub>1</sub> -J <sub>2</sub>
1 dB Bit	2 dB Bit	4 dB Bit	8 dB Bit	16 dB Bit					
-5	-5	0	-5	0	-5	0	-5	0	Reference I.L.
0	-5	0	-5	0	-5	0	-5	0	1 dB
-5	0	-5	-5	0	-5	0	-5	0	2 dB
-5	-5	0	0	-5	-5	0	-5	0	4 dB
-5	-5	0	-5	0	0	-5	-5	0	8 dB
-5	-5	0	-5	0	-5	0	0	-5	16 dB
0	0	-5	0	-5	0	-5	0	-5	31 dB Max. Atten.

**Pin Out**

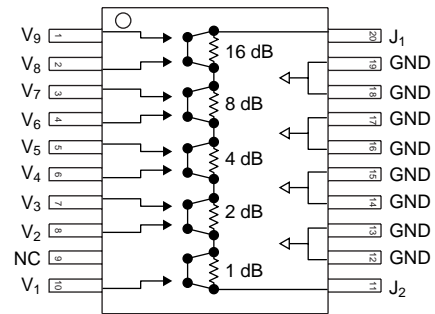

**Absolute Maximum Ratings**

Characteristic	Value
RF Input Power	2.0 W > 500 MHz 0/-8 V 0.5 W > 50 MHz 0/-8 V
Control Voltage	+0.2 V, -8 V
Operating Temperature	-40°C to +85°C
Storage Temperature	-65°C to +150°C
Θ <sub>JC</sub>	85°C/W

Note: Exceeding these ratings may cause irreversible damage.