

# Low Noise, Cascadable Silicon Bipolar MMIC Amplifier

## Technical Data

**INA-03170**

### Features

- **Cascadable 50 Ω Gain Block**
- **Low Noise Figure:**  
2.5 dB Typical at 1.5 GHz
- **High Gain:**  
26.0 dB Typical at 1.5 GHz
- **3 dB Bandwidth:**  
DC to 2.8 GHz
- **Unconditionally Stable**  
( $k > 1$ )
- **Low Power Dissipation**
- **Hermetic Gold-Ceramic Surface Mount Package**

### Description

The INA-03170 is a low-noise silicon bipolar Monolithic Microwave Integrated Circuit (MMIC)

feedback amplifier housed in a hermetic, high reliability package. It is designed for narrow or wide bandwidth commercial, industrial and military applications that require high gain and low noise IF or RF amplification with minimum power consumption.

The INA series of MMICs is fabricated using HP's 10 GHz  $f_T$ , 25 GHz  $f_{MAX}$ , ISOSAT™-I silicon bipolar process which uses nitride self-alignment, submicrometer lithography, trench isolation, ion implantation, gold metallization and polyimide intermetal dielectric and scratch protection to achieve excellent performance, uniformity and reliability.

### 70 mil Package

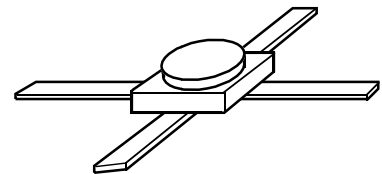

### Typical Biasing Configuration

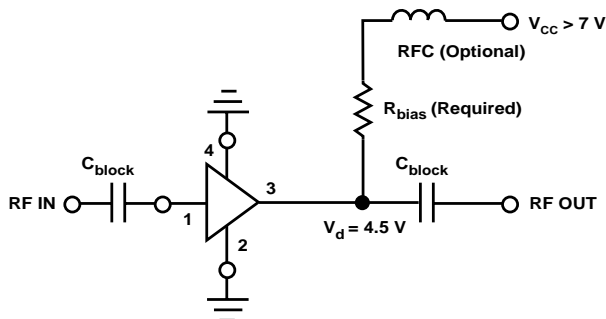

## INA-03170 Absolute Maximum Ratings

Parameter	Absolute Maximum <sup>[1]</sup>
Device Current	25 mA
Power Dissipation <sup>[2,3]</sup>	200 mW
RF Input Power	+13 dBm
Junction Temperature	200°C
Storage Temperature	-65 to 200°C

### Thermal Resistance<sup>[2,4]:</sup>

$$\theta_{jc} = 150^{\circ}\text{C}/\text{W}$$

#### Notes:

1. Permanent damage may occur if any of these limits are exceeded.
2.  $T_{\text{CASE}} = 25^{\circ}\text{C}$ .
3. Derate at  $6.7 \text{ mW}/^{\circ}\text{C}$  for  $T_{\text{C}} > 170^{\circ}\text{C}$ .
4. See MEASUREMENTS section "Thermal Resistance" for more information.

## INA-03170 Electrical Specifications<sup>[1]</sup>, $T_{\text{A}} = 25^{\circ}\text{C}$

Symbol	Parameters and Test Conditions: $I_{\text{d}} = 12 \text{ mA}$ , $Z_{\text{O}} = 50 \Omega$	Units	Min.	Typ.	Max.
$G_{\text{P}}$	Power Gain ( $ S_{21} ^2$ ) $f = 1.5 \text{ GHz}$	dB	24.5	28.0	30.0
$\Delta G_{\text{P}}$	Gain Flatness $f = 0.01 \text{ to } 2.0 \text{ GHz}$	dB		$\pm 0.5$	
$f_{3 \text{ dB}}$	3 dB Bandwidth <sup>[2]</sup>	GHz		2.8	
ISO	Reverse Isolation ( $ S_{12} ^2$ ) $f = 0.01 \text{ to } 2.0 \text{ GHz}$	dB		37	
VSWR	Input VSWR $f = 0.01 \text{ to } 2.0 \text{ GHz}$			2.0 <sup>[3]</sup>	
	Output VSWR $f = 0.01 \text{ to } 2.0 \text{ GHz}$			3.0 <sup>[3]</sup>	
NF	50 $\Omega$ Noise Figure $f = 1.5 \text{ GHz}$	dB		2.5	3.0
$P_{1 \text{ dB}}$	Output Power at 1 dB Gain Compression $f = 1.5 \text{ GHz}$	dBm		1.0	
$\text{IP}_3$	Third Order Intercept Point $f = 1.5 \text{ GHz}$	dBm		10	
$t_{\text{D}}$	Group Delay $f = 1.5 \text{ GHz}$	psec		200	
$V_{\text{d}}$	Device Voltage $f = 1.5 \text{ GHz}$	V	4.0	5.3	6.0
dV/dT	Device Voltage Temperature Coefficient	mV/ $^{\circ}\text{C}$		+5	

#### Notes:

1. The recommended operating current range for this device is 8 to 20 mA. Typical performance as a function of current is on the following page.
2. Referenced from 10 MHz Gain ( $G_{\text{P}}$ ).
3. VSWR can be improved by bypassing the bias directly to ground.

## INA-03170 Typical Scattering Parameters ( $Z_{\text{O}} = 50 \Omega$ , $T_{\text{A}} = 25^{\circ}\text{C}$ , $I_{\text{d}} = 12 \text{ mA}$ )

Freq. GHz	$S_{11}$		$S_{21}$			$S_{12}$			$S_{22}$		k
	Mag	Ang	dB	Mag	Ang	dB	Mag	Ang	Mag	Ang	
0.05	.35	178	26.6	21.48	-4	-35.9	.016	9	.56	-1	1.24
0.10	.35	176	26.6	21.42	-7	-36.5	.015	6	.56	-4	1.29
0.20	.34	172	26.6	21.37	-14	-36.5	.015	-1	.56	-7	1.30
0.40	.34	164	26.5	21.19	-28	-36.5	.015	-5	.54	-13	1.33
0.60	.33	158	26.4	20.91	-41	-38.4	.012	2	.53	-18	1.58
0.80	.32	152	26.3	20.69	-54	-37.1	.014	5	.51	-22	1.46
1.00	.32	147	26.2	20.48	-67	-36.5	.015	4	.50	-27	1.41
1.20	.32	141	26.2	20.40	-80	-39.2	.011	13	.49	-32	1.79
1.40	.31	133	26.3	20.73	-93	-37.7	.013	25	.48	-38	1.57
1.60	.31	125	26.5	21.15	-106	-37.1	.014	28	.47	-45	1.47
1.80	.30	117	26.8	21.84	-121	-35.4	.017	30	.46	-52	1.28
2.00	.27	106	26.9	22.20	-138	-37.1	.014	33	.42	-62	1.48
2.50	.15	94	26.6	21.48	-177	-35.4	.017	23	.31	-79	1.44
3.00	.16	159	23.7	15.32	133	-34.4	.019	42	.16	-72	1.78
3.50	.28	150	19.8	9.81	99	-35.4	.017	28	.19	-60	2.71

# INA-03170 Typical Performance, $T_A = 25^\circ\text{C}$

(unless otherwise noted)

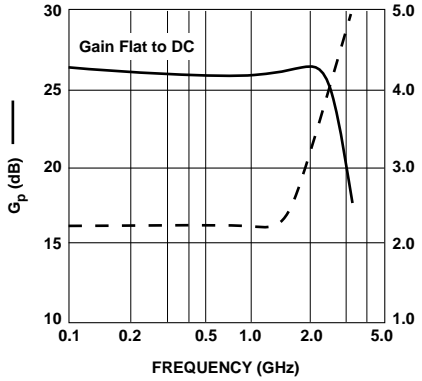

Figure 1. Typical Gain and Noise Figure vs. Frequency,  $T_A = 25^\circ\text{C}$ ,  $I_d = 12\text{ mA}$ .

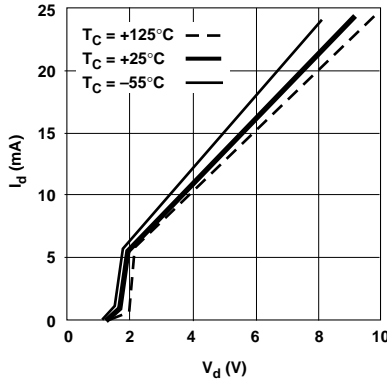

Figure 2. Device Current vs. Voltage.

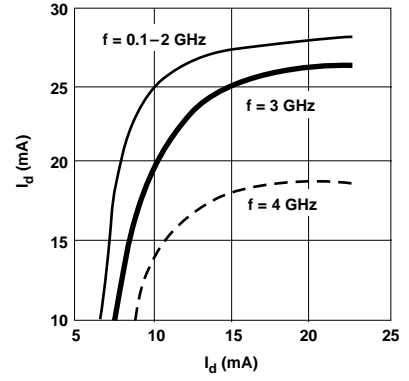

Figure 3. Power Gain vs. Current.

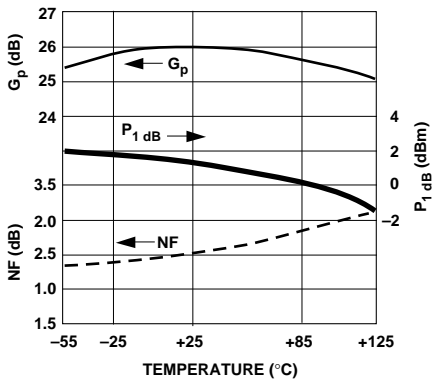

Figure 4. Output Power and 1 dB Gain Compression, NF and Power Gain vs. Case Temperature,  $f = 1.5\text{ GHz}$ ,  $I_d = 12\text{ mA}$ .

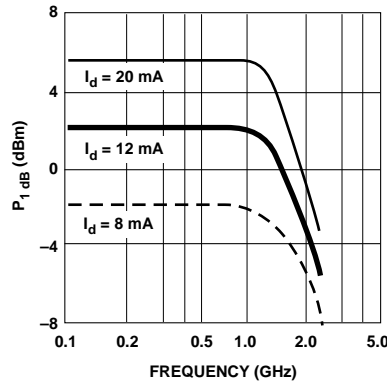

Figure 5. Output Power at 1 dB Gain Compression vs. Frequency.

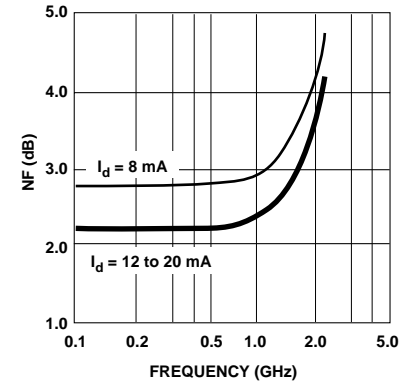

Figure 6. Noise Figure vs. Frequency.

## 70 mil Package Dimensions

