

Powerex, Inc., 200 Hillis Street, Youngwood, Pennsylvania 15697-1800 (412) 925-7272  
 Powerex, Europe, S.A. 428 Avenue G. Durand, BP107, 72003 Le Mans, France (43) 41.14.14

**Fast Recovery Rectifier**  
 700 Amperes Average  
 2600 Volts

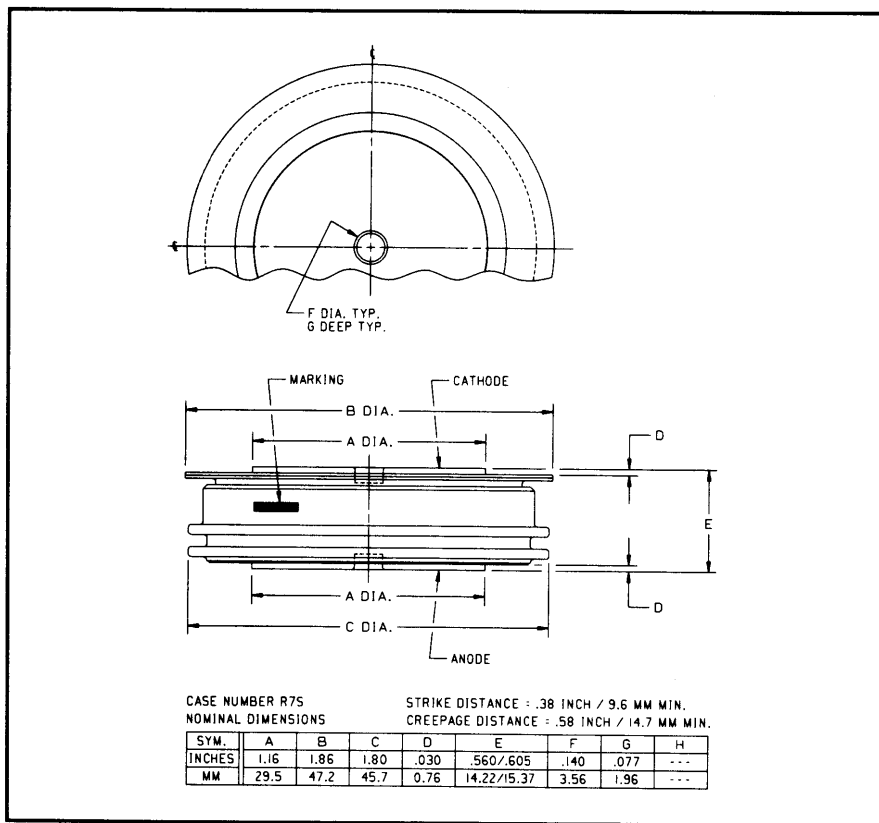

R7S2\_07 (Outline Drawing)

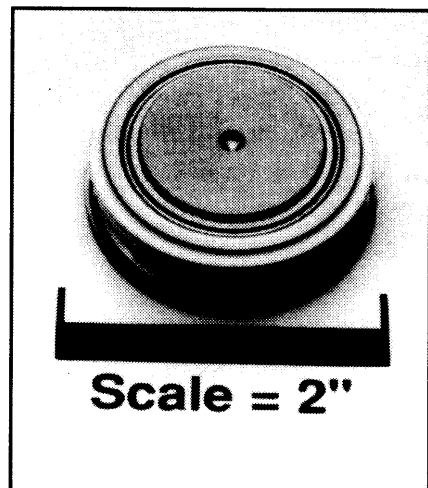

R7S2\_07  
 Fast Recovery Rectifier  
 700 Amperes Average, 2600 Volts

### Ordering Information:

Select the complete part number you desire from the following table:

Type	Voltage		Current		Recovery Time		Leads	
	V <sub>RRM</sub> (Volts)	Code	I <sub>F(av)</sub> (A)	Code	t <sub>rr</sub> (μsec)	Code	Case	Code
R7S2	400	04	700	07	2.0	ES	R7S	00
	600	06						
	800	08						
	1000	10						
	1200	12						
	1400	14						
	1600	16						
	1800	18						
	2000	20						
	2200	22						
	2600	26						

**Example:** Type R7S2 rated at 700A average with V<sub>RRM</sub> = 2600V,  
 Recovery Time = 2.0 μsec, order as:

Type	Voltage	Current	Time	Leads
R 7 S 2	2 6	0 7	ES	0 0

### Features:

- Fast Recovery Times
- Soft Recovery Characteristics
- High Surge Current Ratings
- Special Selection of t<sub>rr</sub> and Q<sub>rr</sub> Available
- Low Thermal Impedance
- Low Profile Package

### Applications:

- Inverters
- Choppers
- Transmitters
- Free Wheeling Diode



Powerex, Inc., 200 Hillis Street, Youngwood, Pennsylvania 15697-1800 (412) 925-7272  
 Powerex, Europe, S.A. 428 Avenue G. Durand, BP107, 72003 Le Mans, France (43) 41.14.14

R7S2\_07

Fast Recovery Rectifier

700 Amperes Average, 2600 Volts

### Absolute Maximum Ratings

Characteristics	Symbol	R7S2_07	Units
RMS Forward Current	$I_{F(rms)}$	1100	Amperes
Average Forward Current	$I_{F(av)}$	700	Amperes
One-half Cycle Surge Current	$I_{FSM}$	6500	Amperes
$I^2t$ (for Fusing), Times = 8.3 milliseconds	$I^2t$	176000	$A^2sec$
Max. $I^2t$ Package (for Times = 8.3 milliseconds)	$I^2t$	$50 \times 10^6$	$A^2sec$
Storage Temperature	$T_{stg}$	-40 to +190	$^{\circ}C$
Operating Temperature	$T_j$	-40 to +150	$^{\circ}C$
Mounting Force		2000 to 2400	lbs

### Electrical and Thermal Characteristics

Characteristics	Symbol	Test Conditions	R7S2_07	Units
<b>Current - Conducting State Maximums</b>				
Forward Voltage Drop	$V_{FM}$	$T_j = 25^{\circ}C, I_{FM} = 1500A$	2.25	Volts
<b>Voltage - Blocking State Maximums</b>				
Repetitive Peak Reverse Voltage (Rated Limit)	$V_{RRM}$		2600	Volts
Non-rep. Trans. Peak Rev. Voltage (Rated Limit)	$V_{RSM}$	$t \leq 5.0msec$	2800	Volts
Reverse Leakage Current, mA peak	$I_{RRM}$	$T_j$ at max., $V_{RRM} = \text{Rated}$	50	mA
<b>Switching</b>				
Maximum Reverse Recovery Time	$t_{rr}$	$I_{FM} = 1500, t_p = 190 \mu sec,$ $di_F/dt = 25A/\mu sec, T_C = 25^{\circ}C$	2.0	$\mu sec$
<b>Thermal</b>				
Maximum Resistance, Junction to Case	$R_{\theta(j-c)}$		0.035	$^{\circ}C/Watt$
Maximum Resistance, Case to Sink (Lubricated)	$R_{\theta(c-s)}$		0.025	$^{\circ}C/Watt$

Powerex, Inc., 200 Hillis Street, Youngwood, Pennsylvania 15697-1800 (412) 925-7272  
 Powerex, Europe, S.A. 428 Avenue G. Durand, BP107, 72003 Le Mans, France (43) 41.14.14

**R7S2\_\_07**  
**Fast Recovery Rectifier**  
 700 Amperes Average, 2600 Volts

Reverse Recovery Wave Form

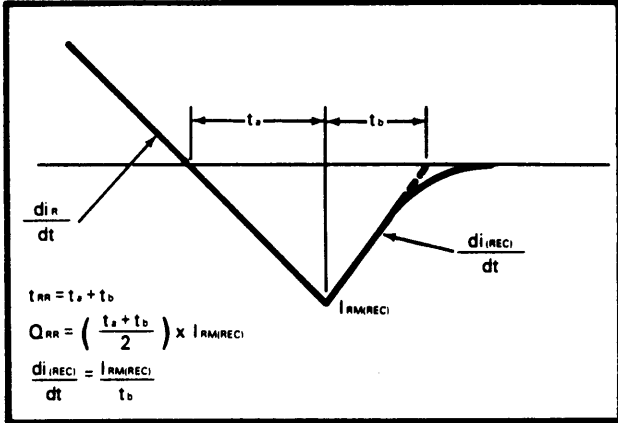

Typical Reverse Recovery Time vs. Rate of Current Fall

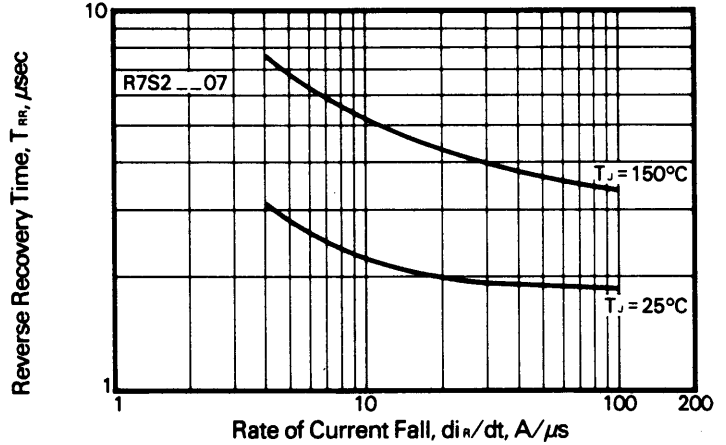

Forward Voltage Drop vs. Forward Current

Forward Voltage Drop,  $V_{FM}$ , Volts

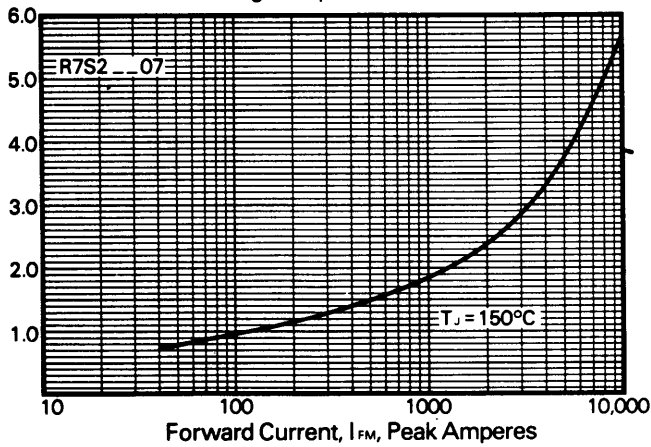

Transient Thermal Impedance Vs. Time

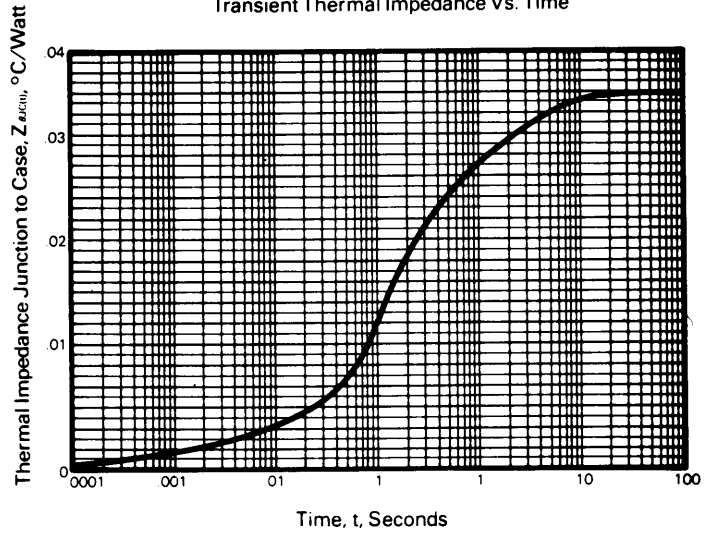

**R7S2\_07**

**Fast Recovery Rectifier**

700 Amperes Average, 2600 Volts

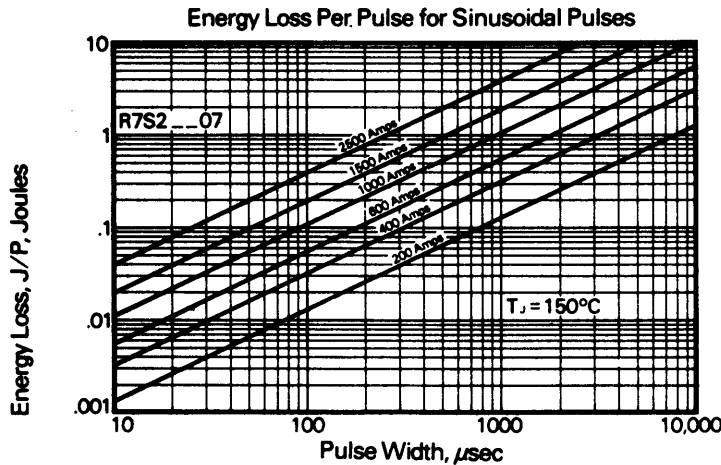
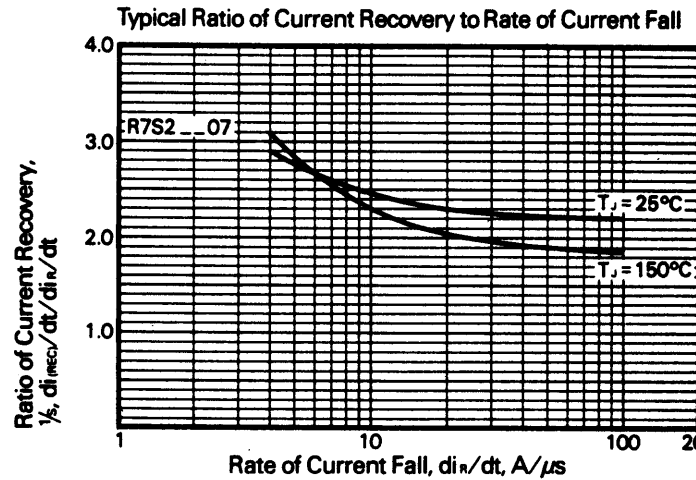
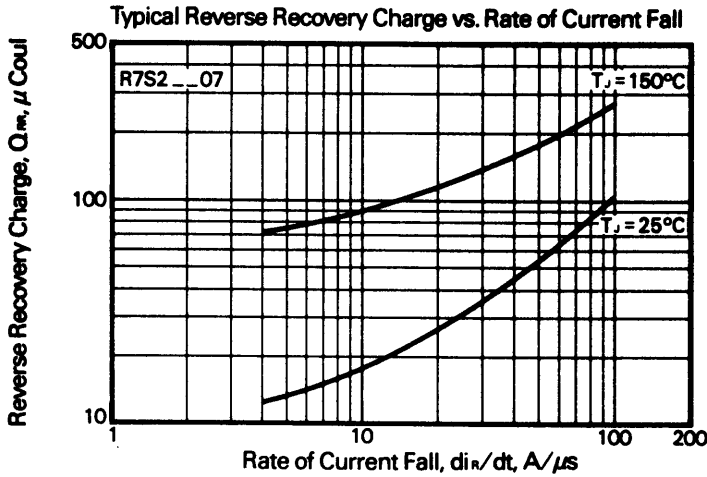

### Calculation of Fast Recovery Diodes and Allowable Case Temperature

1. Conduction Losses

$$P_{av(cond)} = J/P \times F$$

2. Reverse Recovery Losses (Approximate)

$$P_{av(sw)} = 1/4 \times V_R \times \frac{di_R}{dt} \times T_{rr}^2 \times \left( \frac{1/s}{1 + 1/s} \right)^2 \times F \times 1 \times 10^{-6}$$

3. Maximum Allowable Case Temperature

$$T_{C(max)} = T_j - (P_{av(cond)} + P_{av(sw)} \times R_{\theta(j-c)})$$

Where:

$P_{av(cond)}$  = Forward Conduction Power Loss in Watts

$P_{av(sw)}$  = Reverse Recovery Power Loss in Watts

J/P = Energy Loss per Pulse in Joules

F = Frequency in Hertz

$V_R$  = Steady State Reverse Operating Voltage in Volts

$di_R/dt$  = Rate of Decay of Forward Current in Amperes/ $\mu$ sec

$T_{rr}$  = Reverse Recovery Time in Microseconds

$\frac{1}{5}$  = Ratio of Recovery  $di/dt$  ( $\frac{di_F/dt}{di_R/dt}$ )

F = Operating Frequency in Hertz

$T_{C(max)}$  = Maximum Allowable Case Temperature in  $^{\circ}$ C.

$T_j$  = Maximum Operating Junction Temperature in  $^{\circ}$ C.

$R_{\theta(j-c)}$  = DC Junction to Case Thermal Impedance in  $^{\circ}$ C/Watt.