

Damper-Modulator fast, high-voltage

BYM357DX

FEATURES

- Low forward volt drop
- Fast switching
- Soft recovery characteristic
- High thermal cycling performance
- Isolated mounting tab

SYMBOL

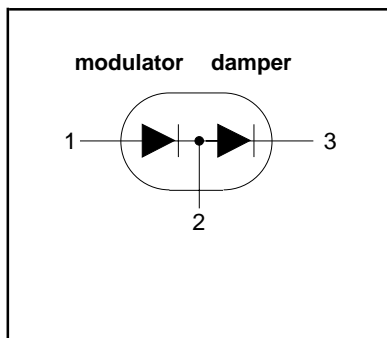

QUICK REFERENCE DATA

DAMPER	MODULATOR
$V_R = 1500\text{ V}$	$V_R = 600\text{ V}$
$V_F \leq 1.3\text{ V}$	$V_F \leq 1.03\text{ V}$
$I_{F(RMS)} = 15.7\text{ A}$	$I_{F(peak)} = 7\text{ A}$
$I_{FSM} \leq 60\text{ A}$	$I_{FSM} \leq 70\text{ A}$
$t_{rr} \leq 300\text{ ns}$	$t_{rr} \leq 60\text{ ns}$

GENERAL DESCRIPTION

Combined damper and modulator diodes in an isolated plastic envelope for horizontal deflection in colour TV and PC monitors. The BYM357DX contains diodes with performance characteristics designed specifically for applications from 16kHz to 70kHz

The BYM357DX series is supplied in the conventional leaded SOT399 package.

PINNING

PIN	DESCRIPTION
1	modulator anode.
2	common anode/cathode
3	damper cathode

SOT399

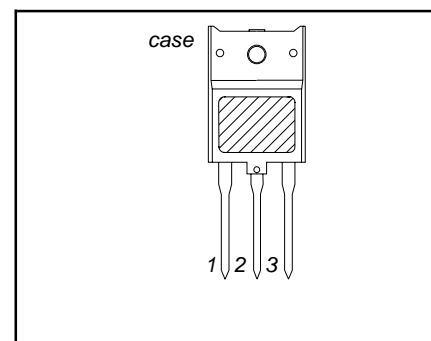

LIMITING VALUES

$T_j = 25\text{ }^\circ\text{C}$ unless otherwise stated

SYMBOL	PARAMETER	CONDITIONS	DAMPER		MODULATOR		UNIT
			MIN	MAX	MIN	MAX	
V_{RSM}	Peak non-repetitive reverse voltage.		-	1500	-	600	V
V_{RRM}	Peak repetitive reverse voltage		-	1500	-	600	V
V_{RWM}	Crest working reverse voltage		-	1300	-	600	V
$I_{F(peak)}$	Peak forward current	31-70kHz monitor	-	7	-	7	A
$I_{F(RMS)}$	RMS forward current	sinusoidal; a=1.57	-	15.7	-	14.1	A
I_{FSM}	Peak non-repetitive forward current	$t = 10\text{ ms}$	-	60	-	70	A
		$t = 8.3\text{ ms}$ sinusoidal; with reapplied $V_{RWM(MAX)}$	-	66	-	77	A
T_{stg}	Storage temperature		-40	150	-40	150	$^\circ\text{C}$
T_j	Operating junction temperature		-	150	-	150	$^\circ\text{C}$

Damper-Modulator fast, high-voltage

BYM357DX

ISOLATION LIMITING VALUE & CHARACTERISTIC

 $T_{hs} = 25\text{ °C}$ unless otherwise specified

SYMBOL	PARAMETER	CONDITIONS	MIN.	TYP.	MAX.	UNIT
V_{isol}	Repetitive peak voltage from all three terminals to external heatsink	R.H. \leq 65 % ; clean and dustfree	-	-	2500	V
C_{isol}	Capacitance from T2 to external heatsink	$f = 1\text{ MHz}$	-	22	-	pF

THERMAL RESISTANCES

SYMBOL	PARAMETER	CONDITIONS	DAMPER		MODULATOR		UNIT
			TYP.	MAX.	TYP.	MAX.	
$R_{th\ j-hs}$	Thermal resistance junction to heatsink	with heatsink compound	-	3.5	-	4	K/W
$R_{th\ j-a}$	Thermal resistance junction to ambient	in free air.	32	-	32	-	K/W

STATIC CHARACTERISTICS OF DAMPER

 $T_j = 25\text{ °C}$ unless otherwise stated

SYMBOL	PARAMETER	CONDITIONS	TYP	MAX.	UNIT
V_F	Forward voltage	$I_F = 6.5\text{ A}$	1.1	1.45	V
I_R	Reverse current	$I_F = 6.5\text{ A}; T_j = 125\text{ °C}$	1.05	1.3	V
		$V_R = V_{RWM}$	10	250	μA
		$V_R = V_{RWM}$ $T_j = 100\text{ °C}$	50	500	μA

STATIC CHARACTERISTICS OF MODULATOR

 $T_j = 25\text{ °C}$ unless otherwise stated

SYMBOL	PARAMETER	CONDITIONS	TYP	MAX.	UNIT
V_F	Forward voltage	$I_F = 8\text{ A}$	1.05	1.25	V
		$I_F = 8\text{ A}; T_j = 125\text{ °C}$	0.9	1.03	V
		$I_F = 20\text{ A}$	1.3	1.45	V
I_R	Reverse current.	$V_R = V_{RWM}$	10	50	μA
		$V_R = V_{RWM}$	100	350	μA
		$T_j = 100\text{ °C}$			

Damper-Modulator fast, high-voltage

BYM357DX

ELECTRICAL CHARACTERISTICS OF DAMPER

$T_j = 25\text{ }^\circ\text{C}$ unless otherwise stated

SYMBOL	PARAMETER	CONDITIONS	TYP.	MAX.	UNIT
t_{rr}	Reverse recovery time	$I_F = 1\text{ A}$; $V_R \geq 30\text{ V}$; $-di_F/dt = 50\text{ A}/\mu\text{s}$	200	300	ns
Q_s	Reverse recovery charge	2 A , 30 V , $20\text{ A}/\mu\text{s}$	1.2	2.0	μC
V_{fr}	Peak forward recovery voltage	$I_F = 6.5\text{ A}$; $di_F/dt = 50\text{ A}/\mu\text{s}$	27	-	V

ELECTRICAL CHARACTERISTICS OF MODULATOR

$T_j = 25\text{ }^\circ\text{C}$ unless otherwise stated

SYMBOL	PARAMETER	CONDITIONS	TYP.	MAX.	UNIT
t_{rr}	Reverse recovery time	$I_F = 1\text{ A}$; $V_R \geq 30\text{ V}$; $-di_F/dt = 100\text{ A}/\mu\text{s}$	35	60	ns
I_{rrm}	Peak reverse recovery current	$I_F = 10\text{ A}$ to $V_R \geq 30\text{ V}$; $di_F/dt = 50\text{ A}/\mu\text{s}$; $T_j = 100\text{ }^\circ\text{C}$	3.0	5.5	A
Q_s	Reverse recovery charge	2 A , 30 V , $20\text{ A}/\mu\text{s}$	40	70	nC
V_{fr}	Peak forward recovery voltage	$I_F = 10\text{ A}$; $di_F/dt = 10\text{ A}/\mu\text{s}$	3.2	-	V

Damper-Modulator
fast, high-voltage

BYM357DX

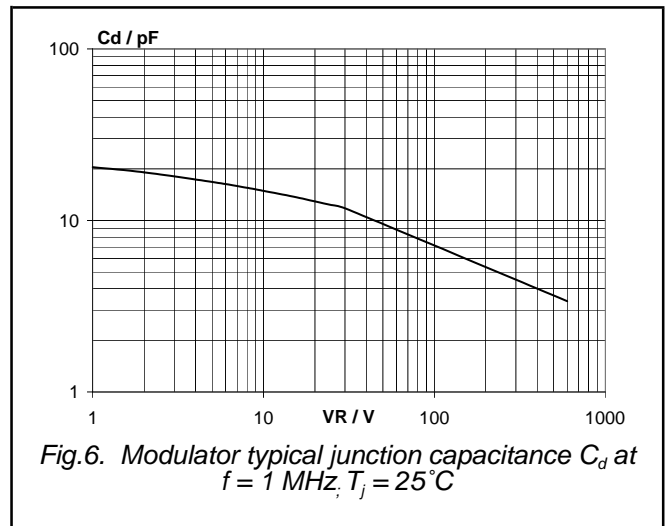
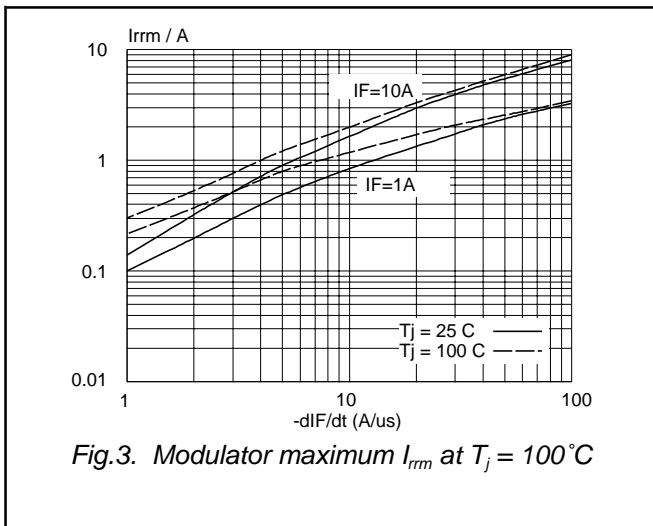
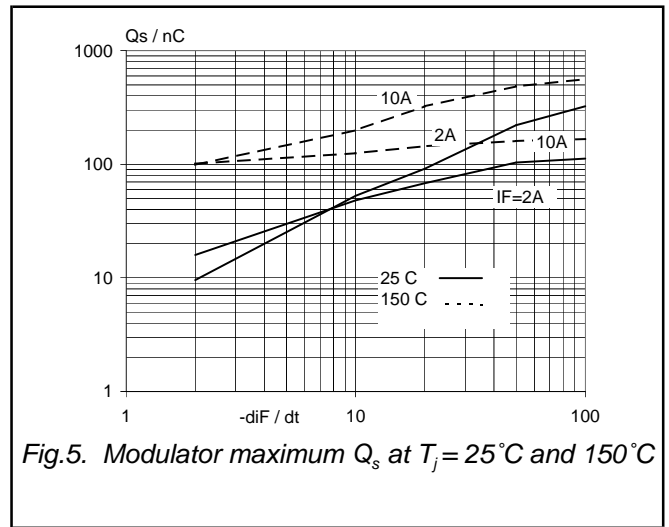
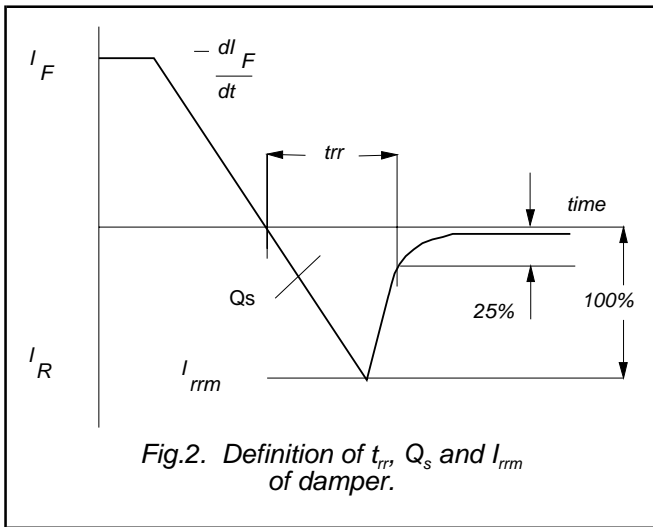
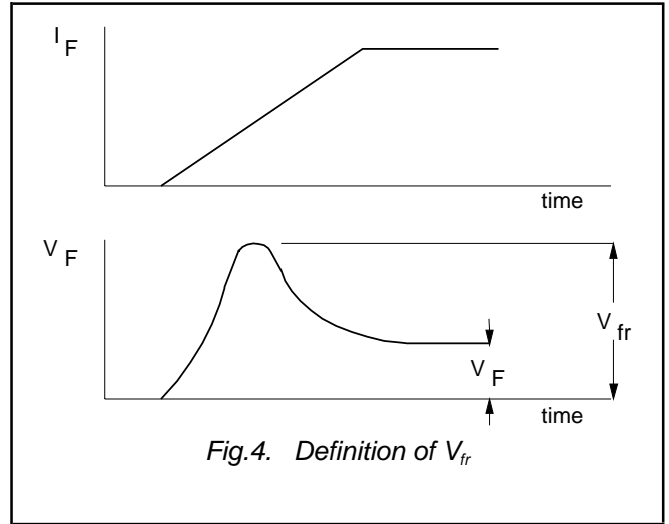
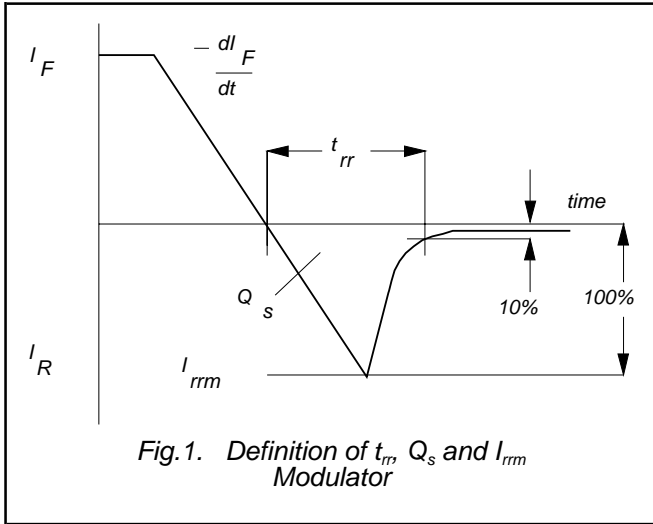

Damper-Modulator
fast, high-voltage

BYM357DX

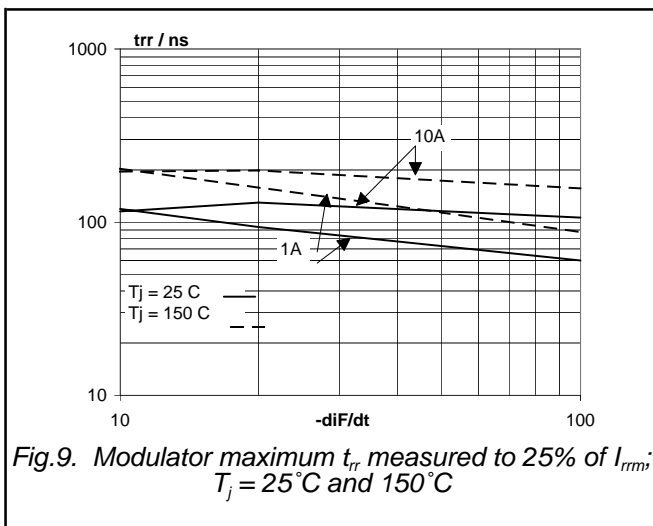
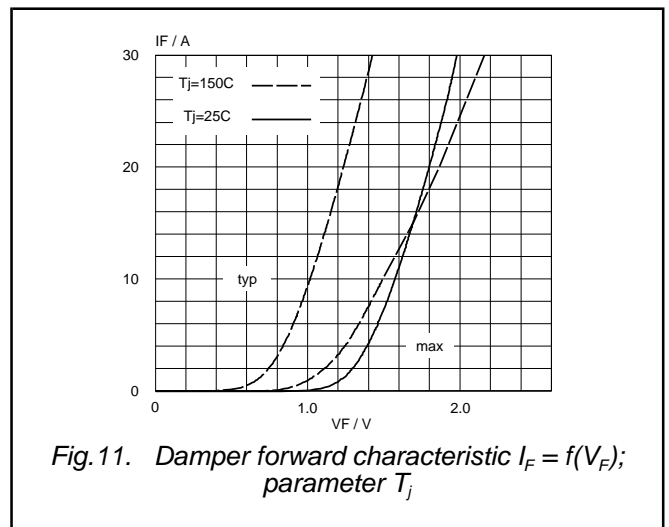
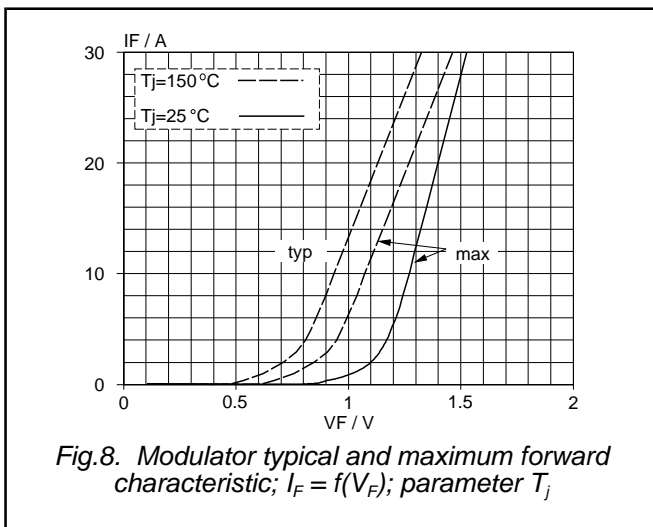
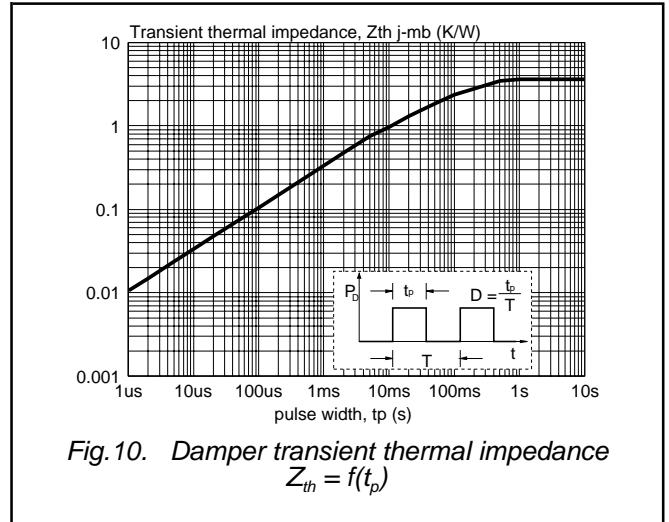
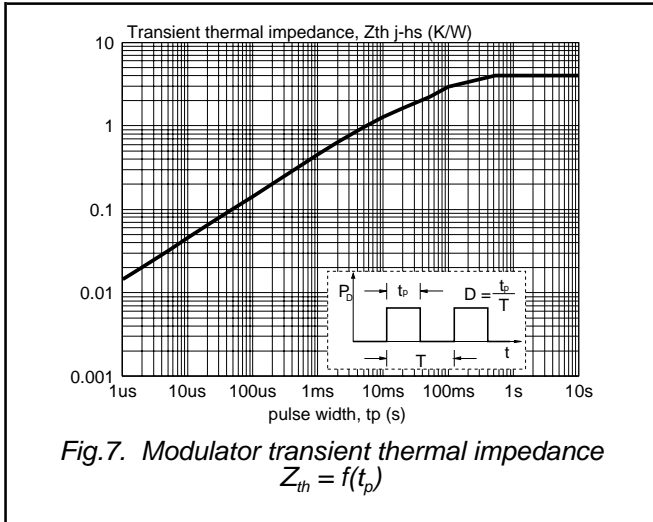

Damper-Modulator
fast, high-voltage

BYM357DX

MECHANICAL DATA

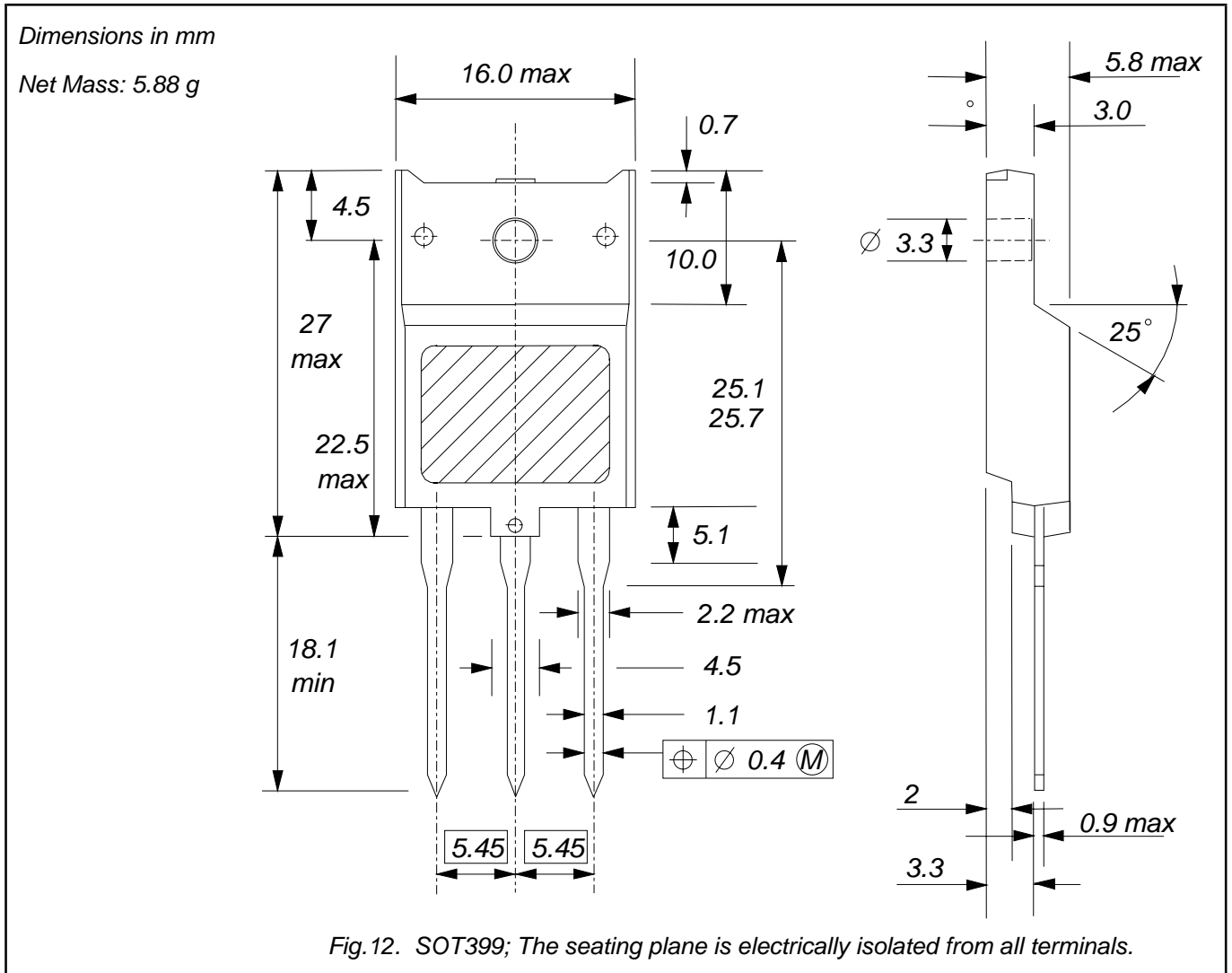

Notes

1. Refer to mounting instructions for F-pack envelopes.
2. Epoxy meets UL94 V0 at 1/8".

Damper-Modulator fast, high-voltage

BYM357DX

DEFINITIONS

Data sheet status	
Objective specification	This data sheet contains target or goal specifications for product development.
Preliminary specification	This data sheet contains preliminary data; supplementary data may be published later.
Product specification	This data sheet contains final product specifications.
Limiting values	
Limiting values are given in accordance with the Absolute Maximum Rating System (IEC 134). Stress above one or more of the limiting values may cause permanent damage to the device. These are stress ratings only and operation of the device at these or at any other conditions above those given in the Characteristics sections of this specification is not implied. Exposure to limiting values for extended periods may affect device reliability.	
Application information	
Where application information is given, it is advisory and does not form part of the specification.	
© Philips Electronics N.V. 2000	
All rights are reserved. Reproduction in whole or in part is prohibited without the prior written consent of the copyright owner.	
The information presented in this document does not form part of any quotation or contract, it is believed to be accurate and reliable and may be changed without notice. No liability will be accepted by the publisher for any consequence of its use. Publication thereof does not convey nor imply any license under patent or other industrial or intellectual property rights.	

LIFE SUPPORT APPLICATIONS

These products are not designed for use in life support appliances, devices or systems where malfunction of these products can be reasonably expected to result in personal injury. Philips customers using or selling these products for use in such applications do so at their own risk and agree to fully indemnify Philips for any damages resulting from such improper use or sale.