

# Silicon Double Balanced HMIC™ Mixer, 700 - 1200 MHz

MA4EX950M-1225T

## Features

- SOT-25 Low Cost Miniature Plastic Package
- 7.0 dB Typical Conversion Loss
- +7 to +13 dBm LO Drive
- HMIC™ Patented Process
- Silicon Medium Barrier Schottky Diodes
- DC - 400 MHz IF Bandwidth

## Description

M/A-COM's MA4EX950M-1225T is a silicon monolithic 700-1200 MHz double balanced mixer in a low cost miniature surface mount SOT-25 package. The die uses M/A-COM's unique HMIC™ silicon/glass process to achieve low loss passive elements while retaining the advantages of medium barrier silicon Schottky diodes.

## Applications

These mixers are well suited for high volume wireless and cellular applications where small size and repeatability are required. Typical applications include frequency conversion, modulation, and demodulation in wireless receivers and transmitters.

## Absolute Maximum Ratings<sup>1</sup>

Parameter	Absolute Maximum
Operating Temperature	-65 °C to +125 °C
Storage Temperature	-65 °C to +150 °C
Incident LO Power	+20 dBm
Incident RF Power	+20 dBm
Mounting Temperature	+235 °C for 10 seconds

1. Exceeding these limits may cause permanent damage.

## SOT-25 Package Outline (Topview)

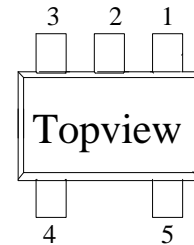

## PIN Configuration

PIN	Function	PIN	Function
1	RF	4	GND
2	GND	5	IF
3	LO		

## Functional Schematic

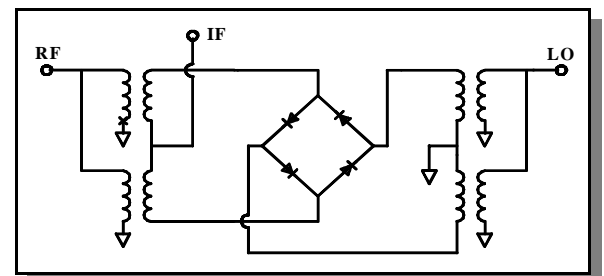

Electrical Specifications:  $T_A = + 25\text{ }^\circ\text{C}$

Parameter	Frequency Range	Test Conditions	Units	Min.	Typ.	Max.
Conversion Loss	850 MHz 0.7—1.2 GHz	LO Drive = +10 dBm RF = -10 dBm, IF = 60 MHz	dB		7.0 8.1	8.0 10.5
L - R Isolation	850 MHz 0.7—1.2 GHz	LO Drive = +5 dBm RF Level = -10 dBm	dB		26.0 20.5	
L - I Isolation	850 MHz 0.7—1.2 GHz	LO Drive = +5 dBm RF Level = -10 dBm	dB		26.5 27.0	
R - I Isolation	850 MHz 0.7—1.2 GHz	LO Drive = +5 dBm RF Level = -10 dBm	dB		27.5 24.0	
LO VSWR	850 MHz 0.7—1.2 GHz	LO Drive = +5 dBm RF Level = -10 dBm			1.8:1 1.8:1	- -
RF VSWR	850 MHz 0.7—1.2 GHz	LO Drive = +5 dBm RF Level = -10 dBm			1.6:1 2.5:1	- -
IF VSWR	DC - 400 MHz	LO Drive = +5 dBm RF Level = -10 dBm			1.05:1	-
Input IP3	850 MHz 0.7—1.2 GHz	LO Drive = +3 → +7 dBm RF = -10 dBm, IF = 60 MHz	dBm	18.5 13.0	20.5 18.0	
Input 1 dB Compression	850 MHz 0.7—1.2 GHz	LO Drive = +3 → +7 dBm RF = -10 dBm, IF = 60 MHz	dBm		4.3 5.6	
IF 1 dB Bandwidth	DC - 400 MHz	LO = 4650 MHz @ =5 dBm	MHz	0		400.0

Typical Performance Curves (LO Drive = +10 dBm, RF = -10 dBm, IF = 60 MHz)

Conversion Loss

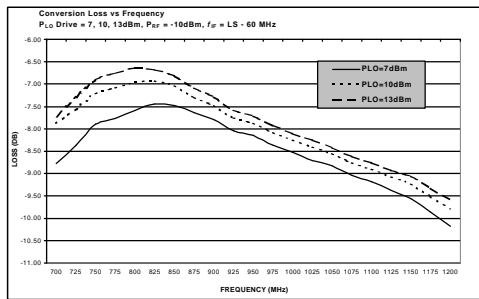

Isolation

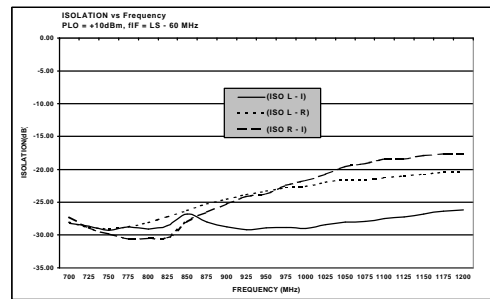

RF and IF VSWR

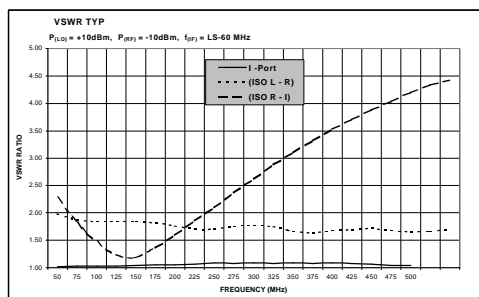

Third Order Intercept and Input 1 dB Compression Power

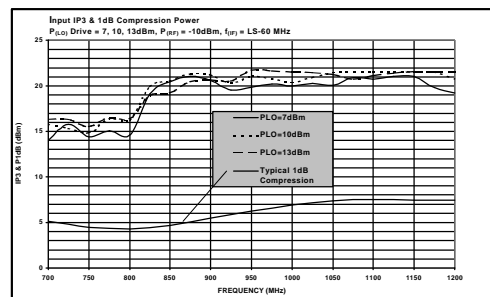

Specifications subject to change without notice.

- North America: Tel. (800) 366-2266
- Asia/Pacific: Tel. +81-44-844-8296, Fax +81-44-844-8298
- Europe: Tel. +44 (1344) 869 595, Fax +44 (1344) 300 020

Visit [www.macom.com](http://www.macom.com) for additional data sheets and product information.

SOT-25 Package Outline<sup>1,2</sup>

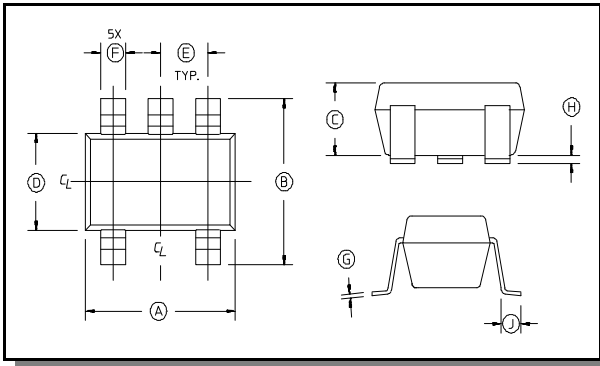

1. Dimensions do not include mold flash, protrusion or gate burrs which shall not exceed 0.0098 in (.25mm) per side.
2. Lead Coplanarity is 0.003 (0.08) max.

SOT-25 Dimensions

Dim	Inches		Millimeters	
	Min.	Max.	Min.	Max.
A		.122	2.70	3.10
B	.100	.118	2.54	3.00
C	b	.051	b	1.30
D	.063 REF.		1.60 REF.	
E	.032	.043	.80	1.10
F	.014	.020	.35	.50
G	.003	b	.08	—
H	.000	.006	.00	.15
J	.018 REF.		.45 REF.	

Ordering Information

Part Number	Package
MA4EX950M-1225T	Tape and Reel

Specifications subject to change without notice.

- North America: Tel. (800) 366-2266
- Asia/Pacific: Tel.+81-44-844-8296, Fax +81-44-844-8298
- Europe: Tel. +44 (1344) 869 595, Fax+44 (1344) 300 020

Visit [www.macom.com](http://www.macom.com) for additional data sheets and product information.