

EVALUATION KIT
AVAILABLE

MAXIM

Low-Cost Downconverter with Low-Noise Amplifier

MAX2406

General Description

The MAX2406 low-noise amplifier (LNA)/downconverter mixer is designed for use over a wide range of frequencies and is optimized for communications systems operating at a frequency of 1.9GHz. Applications include PWT1900/DCT1900, DCS1800/PCS1900, PHS, and DECT. This device includes an LNA, a downconverter mixer, and a local-oscillator (LO) buffer in a low-cost, plastic surface-mount package. At 1.9GHz, the LNA has 2.5dB typical noise figure and a -9.5dBm input third-order intercept point (IP3). The downconverter mixer has a low 9.1dB noise figure and a 4.5dBm input IP3. Image and LO filtering are implemented off-chip for maximum flexibility.

The MAX2406 has a differential IF port that can be used in a single-ended configuration by tying the unused side to V_{CC}. The LO buffer can be driven differentially or in a single-ended configuration with only -10dBm of LO power. Power consumption is 60mW in receive mode, and typically drops to less than 1μW in shutdown mode.

For transceiver applications, the MAX2410 or MAX2411A both offer a transmitter along with a similar receiver.

Applications

PWT1900/DCT1900

DCS1800/PCS1900

PHS/PACS

DECT

Functional Diagram

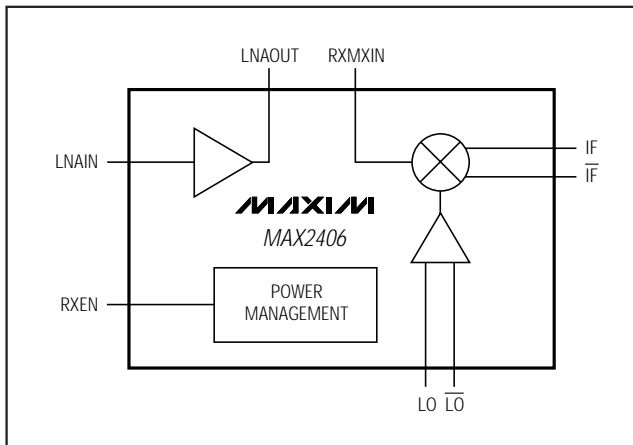

Typical Application Functional Diagram appears at end of data sheet.

MAXIM

Features

- ◆ Integrated LNA/Downconverter
- ◆ 3.2dB Combined Receiver Noise Figure:
 - 2.5dB (LNA)
 - 9.1dB (mixer)
- ◆ -12.5dBm Combined Receiver Input IP3:
 - 9.5dBm (LNA)
 - 4.5dBm (mixer)
- ◆ LO Buffer
- ◆ +2.7V to +5.5V Single-Supply Operation
- ◆ 60mW Power Consumption
- ◆ Low-Power Shutdown Mode

Ordering Information

PART	TEMP. RANGE	PIN-PACKAGE
MAX2406EEP	-40°C to +85°C	20 QSOP

Pin Configuration

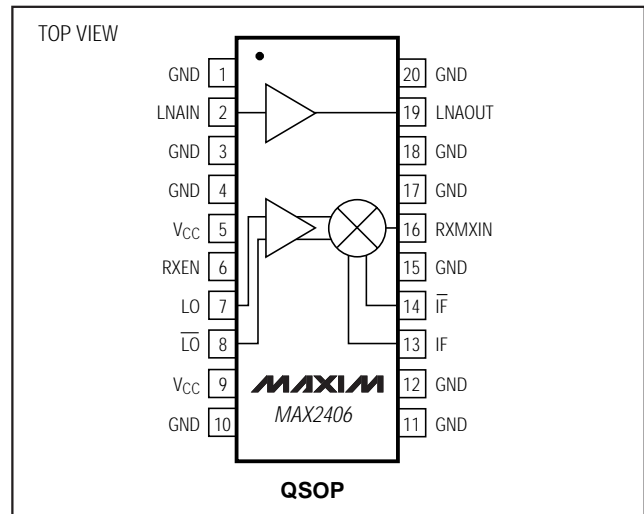

Maxim Integrated Products 1

For free samples & the latest literature: <http://www.maxim-ic.com>, or phone 1-800-998-8800.
For small orders, phone 408-737-7600 ext. 3468.

Low-Cost Downconverter with Low-Noise Amplifier

ABSOLUTE MAXIMUM RATINGS

V _{CC} to GND	-0.3V to 6V	Continuous Power Dissipation (T _A = +70°C)	
LNAIN Input Power	15dBm	QSOP (derate 9.1mW/°C above +70°C)	727mW
LO, $\overline{\text{LO}}$ Input Power	10dBm	Junction Temperature	+150°C
RXMXIN Input Power	10dBm	Operating Temperature Range	-40°C to +85°C
RXEN Voltage to GND	-0.3V to (V _{CC} + 0.3V)	Storage Temperature	-65°C to +165°C
RXEN Current	5mA	Lead Temperature (soldering, 10sec)	+300°C

Stresses beyond those listed under "Absolute Maximum Ratings" may cause permanent damage to the device. These are stress ratings only, and functional operation of the device at these or any other conditions beyond those indicated in the operational sections of the specifications is not implied. Exposure to absolute maximum rating conditions for extended periods may affect device reliability.

DC ELECTRICAL CHARACTERISTICS

(V_{CC} = 2.7V to 5.5V, RXEN = 2V, LNAIN = RXMXIN = open, LNAOUT pulled up with 100Ω to V_{CC}, IF and $\overline{\text{IF}}$ pulled up with 50Ω to V_{CC}, T_A = -40°C to +85°C. Typical values are at T_A = +25°C and V_{CC} = 3.0V, unless otherwise noted.)

PARAMETER	CONDITIONS	MIN	TYP	MAX	UNITS
Supply-Voltage Range		2.7		5.5	V
RXEN Input Voltage High		2.0			V
RXEN Input Voltage Low				0.6	V
RXEN Input Bias Current	RXEN = 2.0V		0.1	1.0	μA
Supply Current, Receive Mode			20	30	mA
Supply Current, Shutdown Mode	RXEN = GND, V _{CC} = 3.0V		0.1	10	μA

AC ELECTRICAL CHARACTERISTICS

(MAX2406EVKIT, Rev. B, V_{CC} = 3.0V, RXEN = V_{CC}, f_{LO} = 1.5GHz, f_{LNAIN} = f_{RXMXIN} = 1.9GHz, P_{LNAIN} = -30dBm, P_{RXMXIN} = -21.5dBm, P_{LO} = -10dBm, differential IF operation, 50Ω system, T_A = +25°C, unless otherwise noted.)

PARAMETER	CONDITIONS	MIN	TYP	MAX	UNITS
LNA Gain (Note 1)	T _A = +25°C	13.6	16	17.6	dB
	T _A = T _{MIN} to T _{MAX}	12.2		18.8	
LNA Noise Figure			2.5		dB
LNA Input IP3	(Note 2)		-9.5		dBm
LNA Output 1dB Compression			-5.6		dBm
Mixer Conversion Gain (Note 1)	T _A = +25°C	7.4	8.4	9.0	dB
	T _A = T _{MIN} to T _{MAX}	6.2		10.2	
Mixer Noise Figure	Single sideband		9.1		dB
Mixer Input IP3	(Note 3)		4.5		dBm
Mixer Input 1dB Compression			-7		dBm
Mixer Output Frequency	(Notes 1 and 4)			450	MHz
Receiver Turn-On Time	(Notes 1 and 5)		0.5	2.5	μs
Minimum LO Drive Level	(Note 6)		-17		dBm
LO to LNAIN Leakage	RXEN = high or low		-49		dBm

Note 1: Guaranteed by design and characterization.

Note 2: 1.9GHz and 1.901GHz tones at -30dBm per tone.

Note 3: 1.9GHz and 1.901GHz tones at -21.5dBm per tone.

Note 4: Mixer operation is guaranteed to this frequency. For optimum gain, adjust IF output match. See the IF Output Impedance (single ended) vs. Frequency graph in the *Typical Operating Characteristics*.

Note 5: Time from RXEN = low to RXEN = high, until the combined receive gain is within 1dB of its final value. Measured with 47pF blocking capacitors on LNAIN and LNAOUT.

Note 6: At this LO drive level, the mixer conversion gain is typically 1dB lower than with -10dBm LO drive.

Low-Cost Downconverter with Low-Noise Amplifier

Typical Operating Characteristics

(MAX2406EVKIT, Rev. B, $V_{CC} = 3.3V$, $R_{XEN} = V_{CC}$, $f_{LO} = 1.5GHz$, $f_{LNAIN} = f_{RXMXIN} = 1.9GHz$, $P_{LNAIN} = -30dBm$, $P_{RXMXIN} = -21.5dBm$, $P_{LO} = -10dBm$, differential IF operation, 50Ω system, $T_A = +25^\circ C$, unless otherwise noted.)

MAX2406

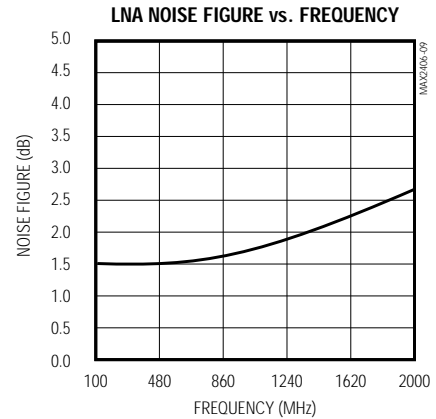
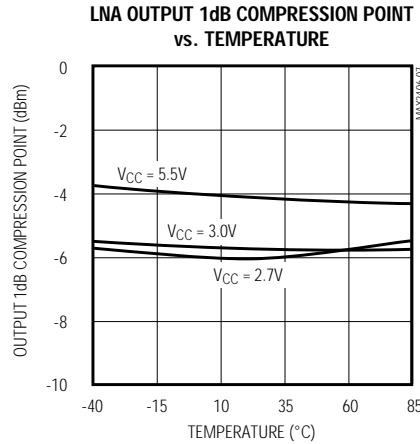
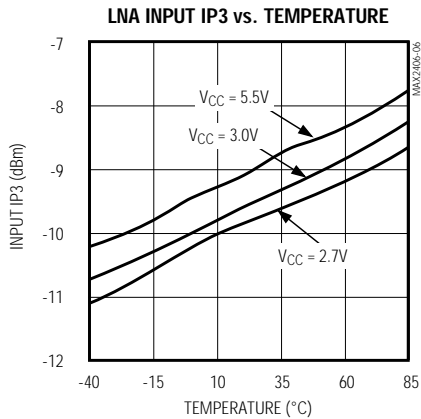
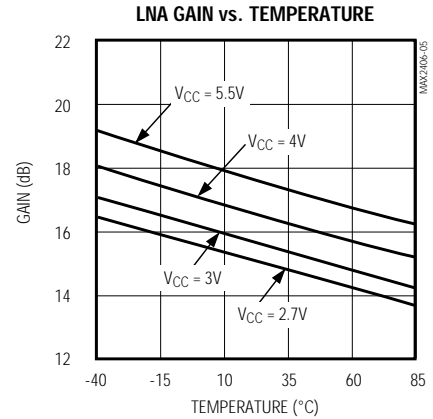
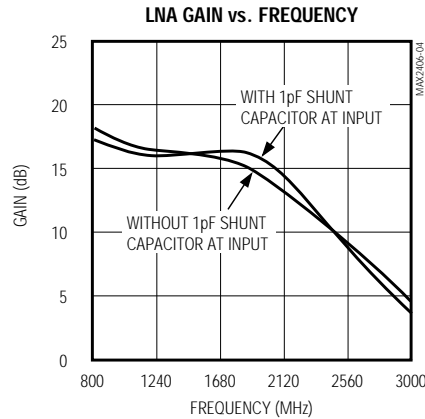
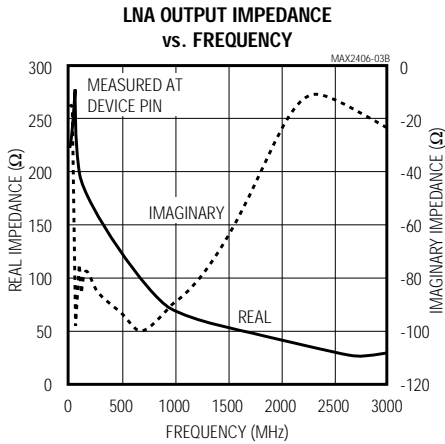
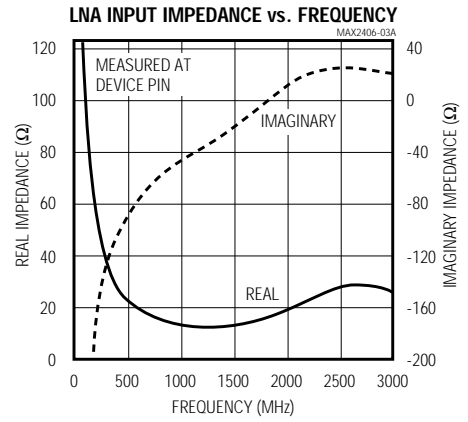
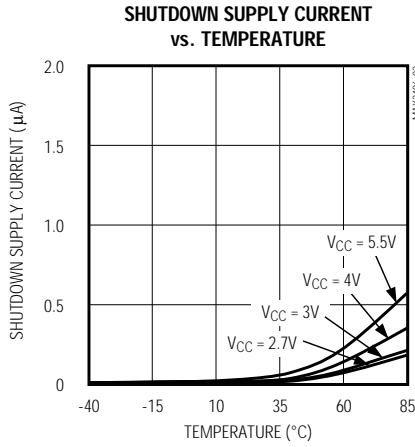
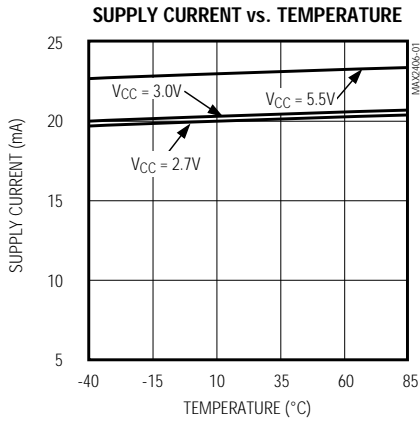

Low-Cost Downconverter with Low-Noise Amplifier

Typical Operating Characteristics (continued)

(MAX2406EVKIT, Rev. B, $V_{CC} = 3.3V$, $R_{XEN} = V_{CC}$, $f_{LO} = 1.5GHz$, $f_{LNAIN} = f_{RXMXIN} = 1.9GHz$, $P_{LNAIN} = -30dBm$, $P_{RXMXIN} = -21.5dBm$, $P_{LO} = -10dBm$, differential IF operation, 50Ω system, $T_A = +25^\circ C$, unless otherwise noted.)

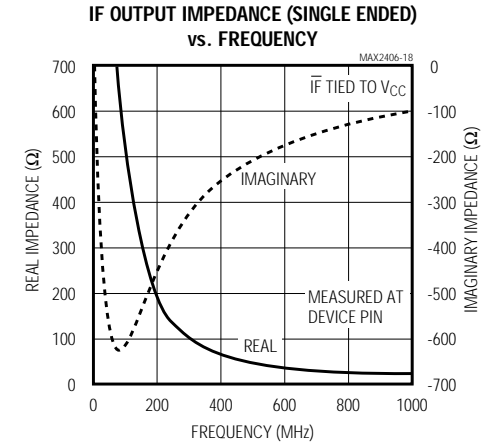
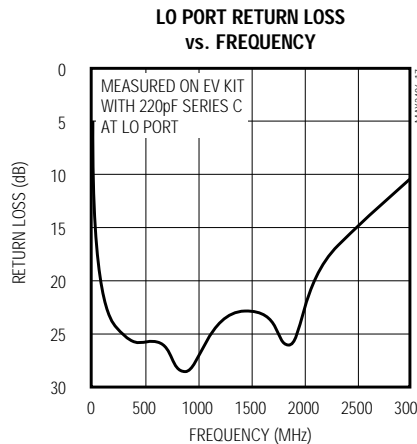
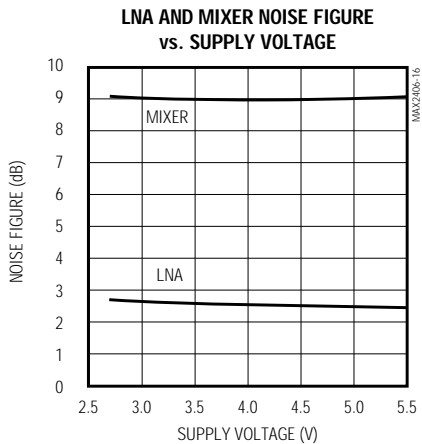
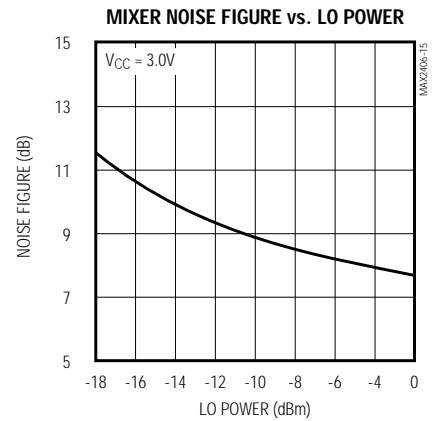
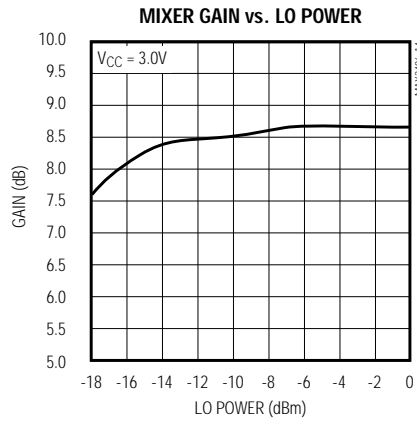
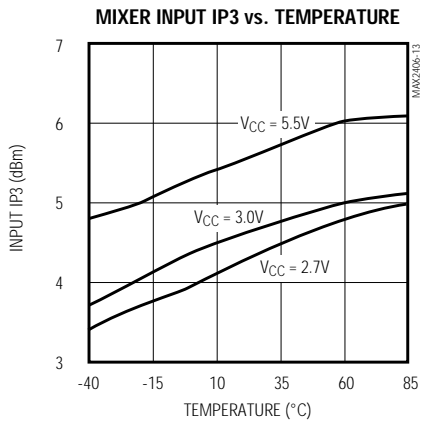
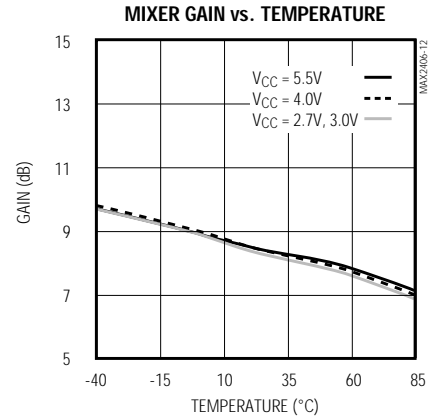
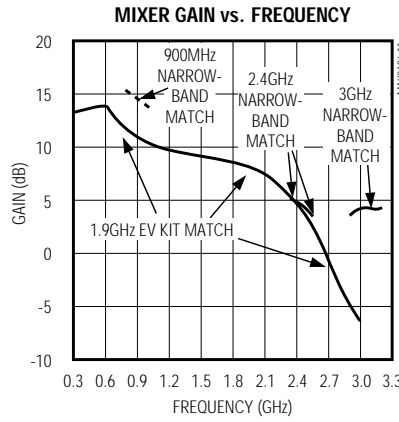
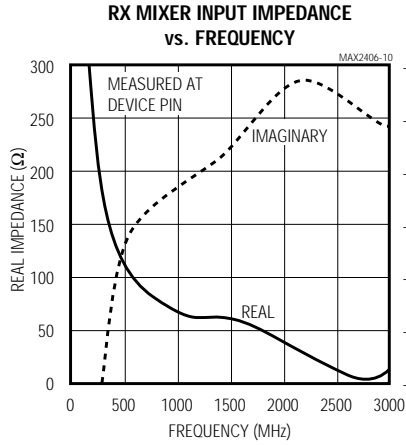

Low-Cost Downconverter with Low-Noise Amplifier

Pin Description

MAX2406

PIN	NAME	FUNCTION
1, 3, 4, 10, 11, 12, 15, 20	GND	Ground. Connect to ground plane with minimal inductance.
2	LNAIN	RF Input to the LNA. At 1.9GHz, LNAIN can be easily matched to 50Ω with one external shunt 1pF capacitor. AC couple to this pin. See the LNA Input Impedance vs. Frequency plot in the <i>Typical Operating Characteristics</i> .
5, 9	V _{CC}	Supply Voltage (+2.7V to +5.5V). Bypass V _{CC} to GND at each pin with a 47pF capacitor as close to each pin as possible.
6	RXEN	Enable Control Input, active high. Logic high activates all part functions. A logic low places the device in shutdown mode.
7	LO	50Ω Local-Oscillator Input Port. AC couple to this pin.
8	$\overline{\text{LO}}$	50Ω Inverting Local-Oscillator Input Port. For single-ended LO operation, connect $\overline{\text{LO}}$ directly to GND. If a differential LO signal is available, AC couple the inverted LO signal to this pin.
13	IF	Noninverting Side of Downconverter's Differential Open-Collector IF Output. Pull IF up to V _{CC} with an inductor. This inductor can be part of the matching network to the desired IF impedance. Alternatively, a resistor can be placed in parallel to set a terminating impedance.
14	$\overline{\text{IF}}$	Inverting Side of Downconverter's Differential Open-Collector IF Output. Follow recommendations for IF output above. If single-ended operation is desired, connect $\overline{\text{IF}}$ directly to V _{CC} .
16	RXXIN	RF Input of Downconverter Mixer. AC couple to this pin. A matching network may be required to match RXXIN to an external filter. Consult the Rx Mixer Input Impedance vs. Frequency plot in the <i>Typical Operating Characteristics</i> .
17	GND	LNA Output Ground. Connect to ground plane with minimal inductance.
18	GND	Downconverter Mixer Input Ground. Connect to ground plane with minimal inductance.
19	LNAOUT	LNA Output. This output typically provides a VSWR of better than 2:1 at frequencies from 1.8GHz to 2.5GHz with no external matching components. At other frequencies, a matching network may be required to match this pin to an external filter. Consult the LNA Output Impedance vs. Frequency plot in the <i>Typical Operating Characteristics</i> .

Detailed Description

The following sections describe each of the blocks in the MAX2406 Functional Diagram.

The MAX2406 consists of four major components: a low-noise amplifier (LNA), a downconverter mixer, a local-oscillator (LO) buffer, and a power-management block.

Low-Noise Amplifier

The LNA is a wideband, single-ended cascode amplifier that can be used over a wide range of frequencies. Refer to the LNA Gain vs. Frequency graph in the *Typical Operating Characteristics*. Its port impedances are optimized for operation around 1.9GHz, requiring only a 1pF shunt capacitor at the LNA input for a VSWR

of better than 2:1 at the input and output. As with every LNA, the input match can be traded off for better noise figure.

Receive Mixer

The receive mixer is a wideband, double-balanced design with excellent noise figure and linearity.

RF Inputs

The RXXIN input is typically connected to the LNA output through an off-chip filter providing enhanced flexibility. This input is externally matched to 50Ω. See Figure 1 for an example matching network for 1.9GHz, and the Rx Mixer Input Impedance vs. Frequency graph in the *Typical Operating Characteristics*.

Low-Cost Downconverter with Low-Noise Amplifier

LO Inputs

The LO and $\overline{\text{LO}}$ pins are internally terminated with 50Ω resistors. See the *Typical Operating Characteristics* for a plot of LO Port Return Loss vs. Frequency. AC couple the local-oscillator signal to these pins. If a single-ended LO source is used, connect $\overline{\text{LO}}$ to ground.

IF Output Port

The receive mixer output appears on the differential IF and $\overline{\text{IF}}$ pins. These open-collector outputs each require an external inductor to V_{CC} for DC biasing. This port typically requires a matching network for coupling to an external IF filter. For single-ended operation, connect the unused side (typically $\overline{\text{IF}}$) to V_{CC} , and decouple it to ground with a 1000pF capacitor. Figure 1 shows examples of single-ended and differential IF port connections. Refer to the IF and $\overline{\text{IF}}$ Output Impedance vs. Frequency plot in the *Typical Operating Characteristics*. At lower IF frequencies, a shunt resistor across the pull-up inductor (in single-ended applications) or across IF and $\overline{\text{IF}}$ (in differential applications) can be used to set the IF impedance.

Power-Down Control

Pulling RXEN low places the MAX2406 in shutdown mode. Power-down is guaranteed with a control voltage at or below 0.6V. The device exits shutdown in 0.5μs typical.

Applications Information

Extended Frequency Range

The MAX2406 has been characterized at 1.9GHz for use in PCS applications; however, it operates over a much wider frequency range. The LNA gain and noise figure, as well as receive mixer conversion gain, are plotted over a wide frequency range in the *Typical Operating Characteristics*. When operating the device at frequencies other than those specified in the specification table, it may be necessary to design or alter the matching networks on LNAIN, RXMIXIN, IF, and (if used) $\overline{\text{IF}}$. In some cases, the internal broadband output match on LNAOUT may have to be supplemented by an external matching circuit. The *Typical Operating Characteristics* provide port-impedance data vs. frequency for use in designing a matching network. The

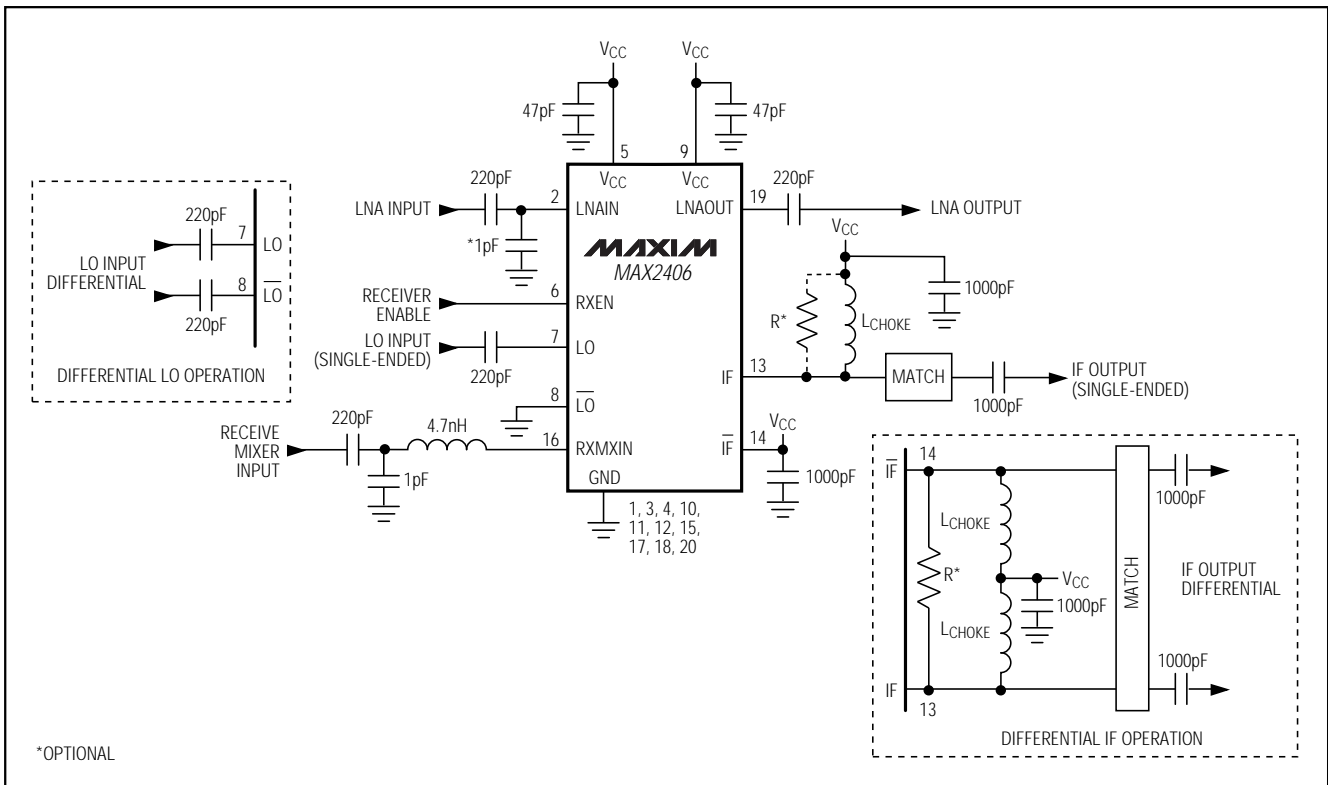
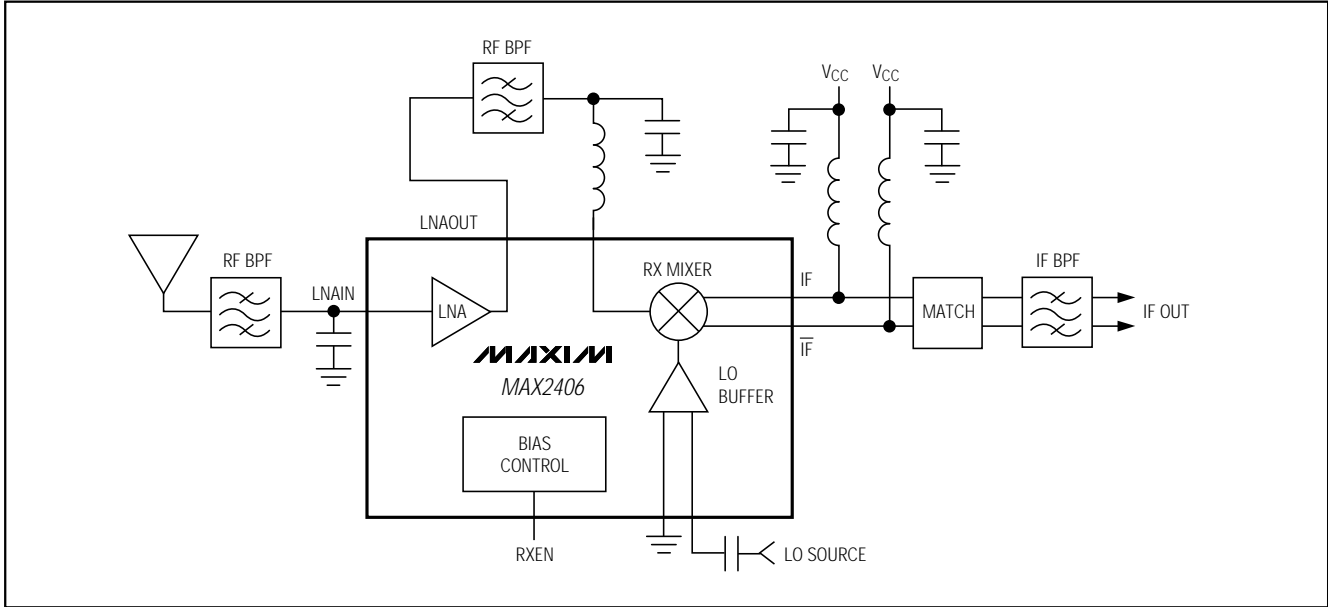

Figure 1. MAX2406 Typical Operating Circuit

Low-Cost Downconverter with Low-Noise Amplifier

Typical Application Functional Diagram

MAX2406



LO port is internally terminated to 50Ω and provides a good match (a VSWR of approximately 1.2:1 to 2GHz, and a VSWR of approximately 2:1 to 3GHz).

Layout

A properly designed PC board is an essential part of any RF/microwave circuit. Be sure to use controlled impedance lines on all high-frequency inputs and outputs, use low-inductance connections to ground on all GND pins, and place decoupling capacitors close to all VCC connections.

For the power supplies, a star topology works well. Each VCC node in the circuit has its own path to a central VCC and a decoupling capacitor that provides low impedance at the RF frequency of interest. The central VCC node has a large decoupling capacitor as well. This provides good isolation between the different sections of the MAX2406. The MAX2406 EV kit layout can be used as a guide to integrating the MAX2406 into your design.

Low-Cost Downconverter with Low-Noise Amplifier

Package Information

QSDP.EPS

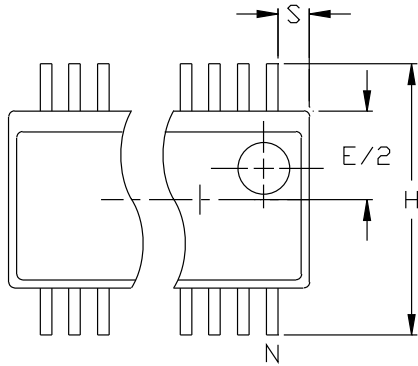

DIM	INCHES		MILLIMETERS	
	MIN	MAX	MIN	MAX
A	.061	.068	1.55	1.73
A1	.004	.0098	0.127	0.25
A2	.055	.061	1.40	1.55
B	.008	.012	0.20	0.31
C	.0075	.0098	0.19	0.25
D	SEE VARIATIONS			
E	.150	.157	3.81	3.99
e	.025 BSC		0.635 BSC	
H	.230	.244	5.84	6.20
h	.010	.016	0.25	0.41
L	.016	.035	0.41	0.89
N	SEE VARIATIONS			
S	SEE VARIATIONS			
?	0°	8°	0°	8°

VARIATIONS:

DIM	INCHES		MILLIMETERS		N
	MIN.	MAX.	MIN.	MAX.	
D	.189	.196	4.80	4.98	16
S	.0020	.0070	0.05	0.18	
D	.337	.344	8.56	8.74	20
S	.0500	.0550	1.27	1.40	
D	.337	.344	8.56	8.74	24
S	.0250	.0300	0.64	0.76	
D	.386	.393	9.80	9.98	28
S	.0250	.0300	0.64	0.76	

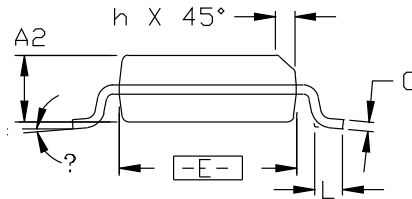
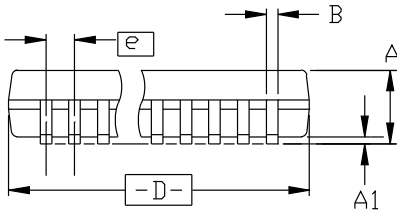

NOTES:

1. D & E DO NOT INCLUDE MOLD FLASH OR PROTRUSIONS
2. MOLD FLASH OR PROTRUSIONS NOT TO EXCEED .006"
3. CONTROLLING DIMENSIONS: INCHES

MAXIM
 PROPRIETARY INFORMATION
 TITLE:
 PACKAGE OUTLINE, QSDP, .150 INCH, .025° LEAD PITCH
 APPROVAL: _____ DOCUMENT CONTROL NO. 21-0055 REV A 1/1