

PNP Silicon AF Transistors

SMBTA 55
SMBTA 56

- High breakdown voltage
- Low collector-emitter saturation voltage
- Complementary types: SMBTA 05, SMBTA 06 (NPN)

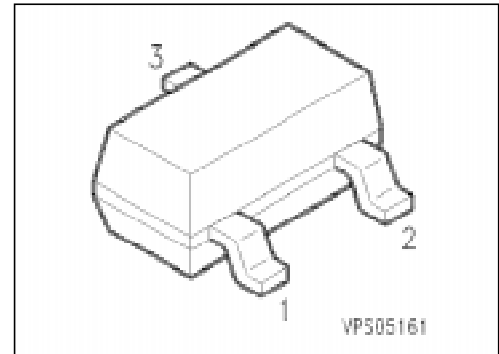

Type	Marking	Ordering Code (tape and reel)	Pin Configuration			Package ¹⁾
			1	2	3	
SMBTA 55 SMBTA 56	s2H s2G	Q68000-A3386 Q68000-A2882	B	E	C	SOT-23

Maximum Ratings

Parameter	Symbol	Values		Unit
		SMBTA 55	SMBTA 56	
Collector-emitter voltage	V_{CE0}	60	80	V
Collector-base voltage	V_{CB0}	60	80	
Emitter-base voltage	V_{EB0}	4		
Collector current	I_C	500		mA
Peak collector current	I_{CM}	1		A
Base current	I_B	100		mA
Peak base current	I_{BM}	200		
Total power dissipation, $T_s = 79\text{ °C}$	P_{tot}	330		mW
Junction temperature	T_j	150		°C
Storage temperature range	T_{stg}	- 65 ... + 150		

Thermal Resistance

Junction - ambient ²⁾	$R_{th\ JA}$	≤ 285	K/W
Junction - soldering point	$R_{th\ JS}$	≤ 215	

¹⁾ For detailed information see chapter Package Outlines.

²⁾ Package mounted on epoxy pcb 40 mm × 40 mm × 1.5 mm/6 cm² Cu.

Electrical Characteristics

at $T_A = 25\text{ °C}$, unless otherwise specified.

Parameter	Symbol	Values			Unit
		min.	typ.	max.	

DC characteristics

Collector-emitter breakdown voltage $I_C = 1\text{ mA}$	$V_{(BR)CE0}$	60 80	– –	– –	V
Collector-base breakdown voltage $I_C = 100\text{ }\mu\text{A}$	$V_{(BR)CB0}$	60 80	– –	– –	
Emitter-base breakdown voltage $I_E = 10\text{ }\mu\text{A}$	$V_{(BR)EB0}$	4	–	–	
Collector-base cutoff current $V_{CB} = 60\text{ V}$ $V_{CB} = 80\text{ V}$ $V_{CB} = 60\text{ V}, T_A = 150\text{ °C}$ $V_{CB} = 80\text{ V}, T_A = 150\text{ °C}$	I_{CB0}	– – – –	– – – –	100 100 20 20	nA nA μA μA
Collector cutoff current $V_{CE} = 60\text{ V}$	I_{CE0}	–	–	100	nA
DC current gain ¹⁾ $I_C = 10\text{ mA}, V_{CE} = 1\text{ V}$ $I_C = 100\text{ mA}, V_{CE} = 1\text{ V}$	h_{FE}	100 100	– 130	– 170	–
Collector-emitter saturation voltage ¹⁾ $I_C = 100\text{ mA}, I_B = 10\text{ mA}$	V_{CEsat}	–	–	0.25	V
Base-emitter saturation voltage ¹⁾ $I_C = 100\text{ mA}, V_{CE} = 1\text{ V}$	V_{BE}	–	–	1.2	

AC characteristics

Transition frequency $I_C = 20\text{ mA}, V_{CE} = 5\text{ V}, f = 20\text{ MHz}$	f_T	–	100	–	MHz
Output capacitance $V_{CB} = 10\text{ V}, f = 1\text{ MHz}$	C_{obo}	–	12	–	pF

¹⁾ Pulse test conditions: $t \leq 300\text{ }\mu\text{s}, D = 2\text{ %}$.

Total power dissipation $P_{tot} = f(T_A^*; T_S)$

* Package mounted on epoxy

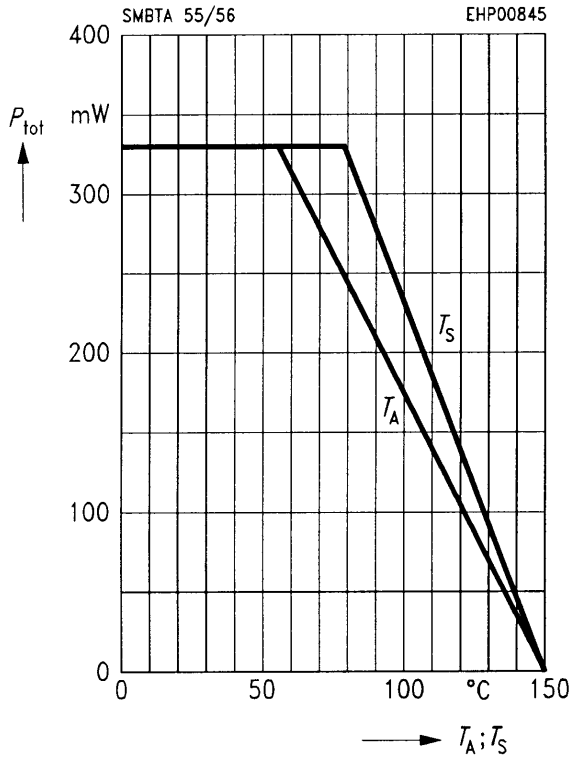

Collector current $I_C = f(V_{BE})$

$V_{CE} = 1\text{ V}$

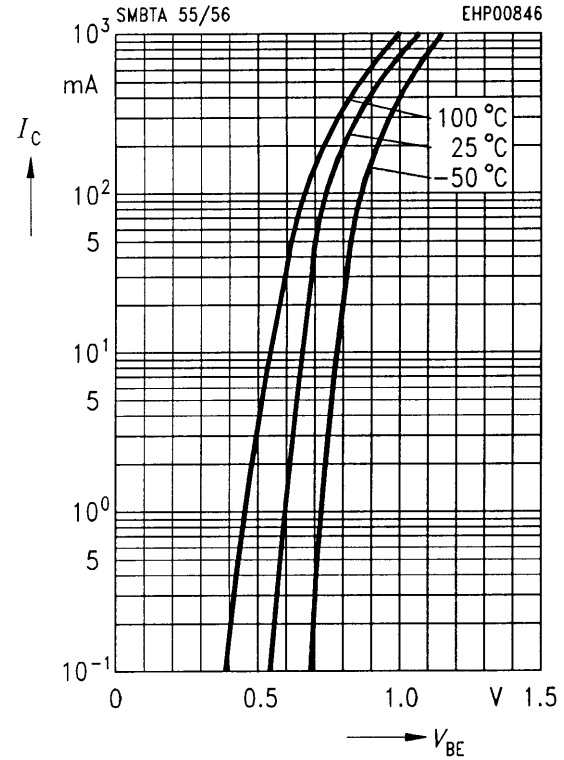

Permissible pulse load $P_{tot\ max}/P_{tot\ DC} = f(t_p)$

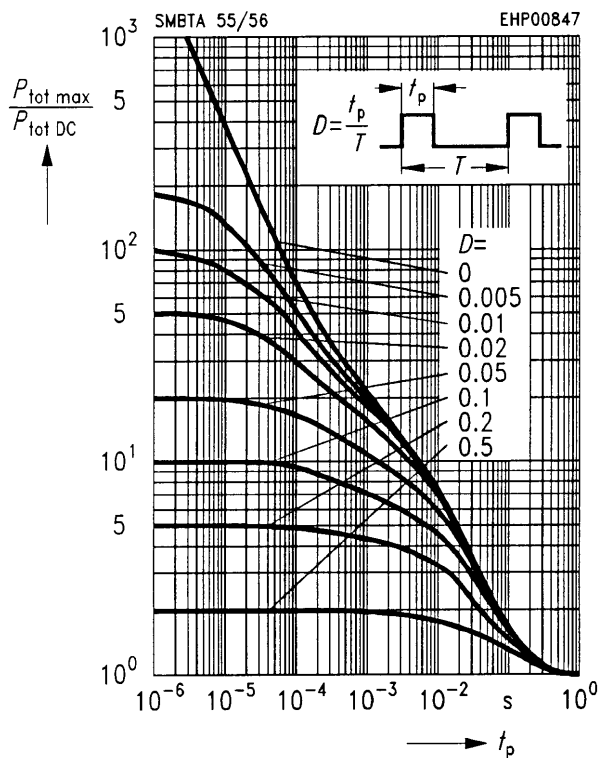

Transition frequency $f_T = f(I_C)$

$V_{CE} = 5\text{ V}$

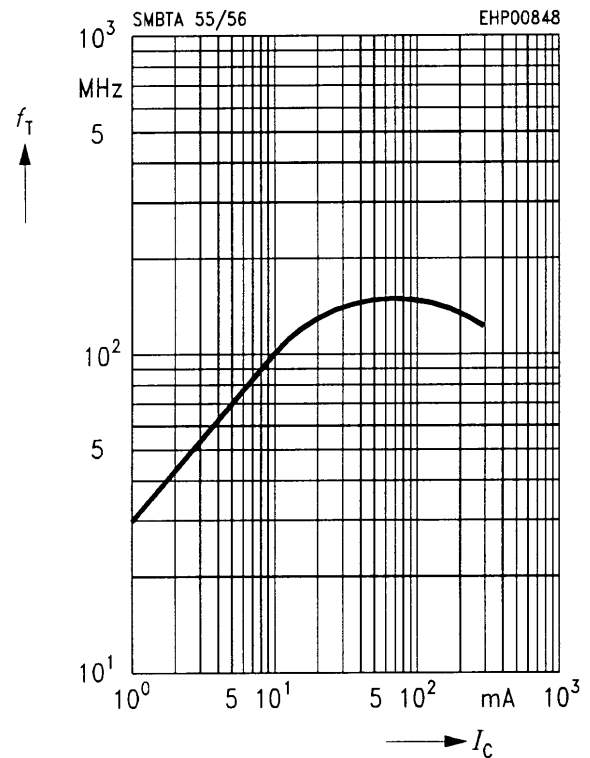

Base-emitter saturation voltage

$$I_C = f(V_{BE\ sat}), h_{FE} = 10$$

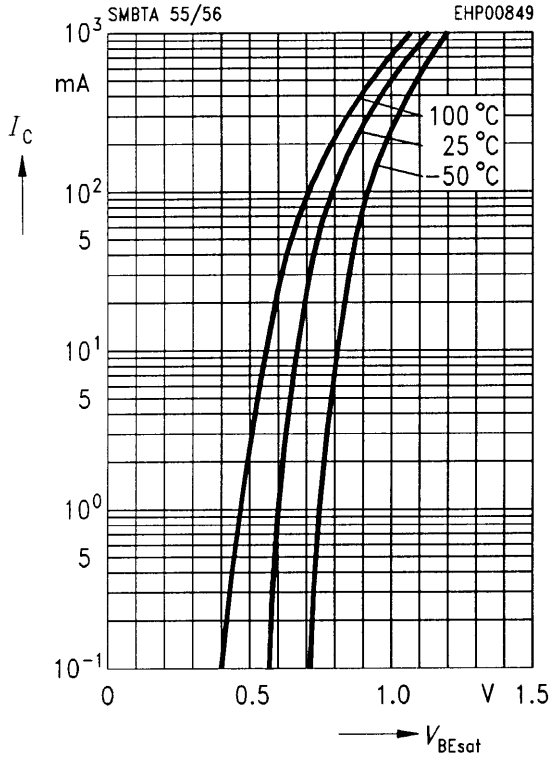

Collector-emitter saturation voltage

$$I_C = f(V_{CE\ sat}), h_{FE} = 10$$

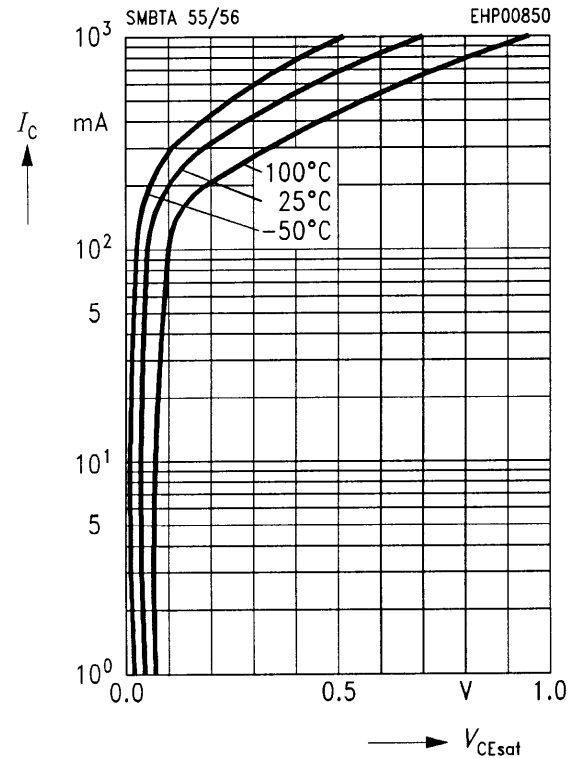

Collector cutoff current $I_{CB0} = f(T_A)$

$$V_{CB} = V_{CE\ max}$$

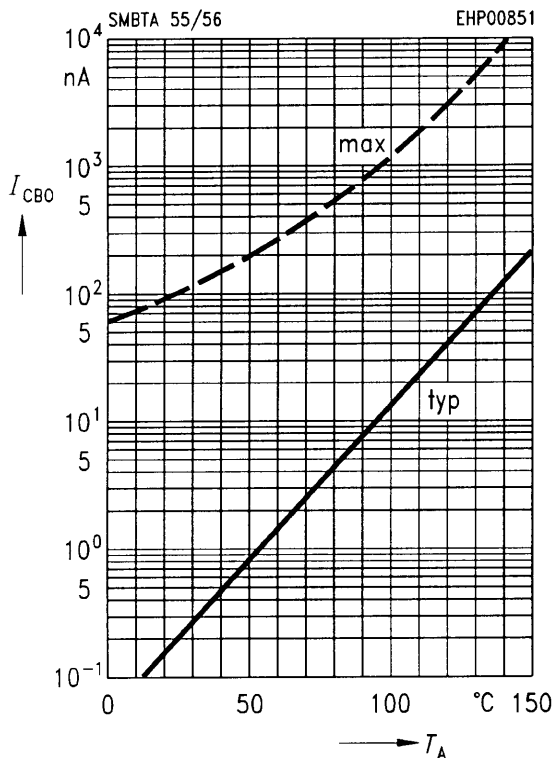

DC current gain $h_{FE} = f(I_C)$

$$V_{CE} = 1\ V$$

