

## 1.5A Low Dropout Voltage Regulator

*Adjustable & Fixed Output, Fast Response Time*

### FEATURES

- Adjustable Output Down To 1.25V
- 1% Output Accuracy
- Output Current of 1.5A
- Low Dropout Voltage of 390mV @ 1.5A
- Extremely Tight Load and Line Regulation
- Extremely Fast Transient Response
- Reverse-Battery Protection
- Zero Current Shutdown (5 pin version)
- Error Flag Signal Output for Out of Regulation State (5 pin version)
- Standard TO-220 and TO-263 Packages

### APPLICATIONS

- Powering VGA & Sound Card
- LCD Monitors
- USB Power Supply
- Power PC™ Supplies
- SMPS Post Regulator
- High Efficiency “Green” Computer Systems
- High Efficiency Linear Power Supplies
- Portable Instrumentation
- Constant Current Regulators
- Adjustable Power Supplies
- Battery Charger

*Now Available in Lead Free Packaging*

Refer to page 8 for pinouts.

### DESCRIPTION

The SPX29150/51/52/53 are 1.5A, highly accuracy voltage regulators with a low drop out voltage of 390mV dropout (typical) @ 1.5A. These regulators are specifically designed for low voltage applications that require a low dropout voltage and a fast transient response. They are fully fault protected against over-current, reverse battery, and positive and negative voltage transients. On-Chip trimming adjusts the reference voltage to 1% initial accuracy. Other features in the 5 pin versions include Enable, and Error Flag.

The SPX29150/51/52/53 is offered in 3 & 5-pin TO-220 & TO-263 packages. For a 3A version, refer to the SPX29300 data sheet.

### TYPICAL APPLICATION CIRCUIT

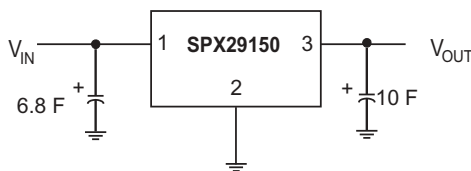


Figure 1. Fixed Output Linear Regulator

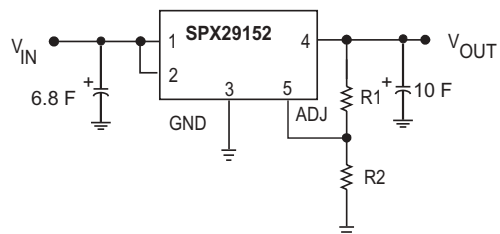


Figure 2. Adjustable Output Linear Regulator

## ABSOLUTE MAXIMUM RATINGS

Lead Temperature (soldering, 5 seconds) .....260°C  
 Storage Temperature Range.....-65°C to +150°C  
 Operating Junction Temperature Range.....-40°C to +125°C  
 Input Voltage (Note 7) ..... 16V

## ELECTRICAL CHARACTERISTICS

at  $V_{IN}=V_{OUT}+1V$  and  $I_{OUT}=10mA$ ,  $C_{IN}=6.8\mu F$ ,  $C_{OUT}=10\mu F$ ,  $T_A=25^\circ C$ , unless otherwise specified. The Boldface applies over the junction temperature range. Adjustable versions are set to 5.0V.

SPX29150/51					
PARAMETER	CONDITIONS	TYP	MIN	MAX	UNITS
<b>Fixed Voltage Options</b>					
<b>1.8V Version</b>					
Output Voltage	$I_{OUT}=10mA$ $10mA \leq I_{OUT} \leq 1.5A, 2.5V \leq V_{IN} \leq 16V$	1.8 <b>1.8</b>	1.782 <b>1.764</b>	1.818 <b>1.836</b>	V
<b>2.5V Version</b>					
Output Voltage	$I_{OUT}=10mA$ $10mA \leq I_{OUT} \leq 1.5A, 3.5V \leq V_{IN} \leq 16V$	2.5 <b>2.5</b>	2.475 <b>2.450</b>	2.525 <b>2.550</b>	V
<b>3.3V Version</b>					
Output Voltage	$I_{OUT}=10mA$ $10mA \leq I_{OUT} \leq 1.5A, 4.3V \leq V_{IN} \leq 16V$	3.3 <b>3.3</b>	3.267 <b>3.234</b>	3.333 <b>3.366</b>	V
<b>5.0V Version</b>					
Output Voltage	$I_{OUT}=10mA$ $10mA \leq I_{OUT} \leq 1.5A, 6.0V \leq V_{IN} \leq 16V$	5.0 <b>5.0</b>	4.950 <b>4.900</b>	5.050 <b>5.100</b>	V
<b>All Voltage Options</b>					
SPX29150/51/52/53					
Line Regulation	$I_{OUT}=10mA, (V_{OUT}+1V) \leq V_{IN} \leq 16V$	0.1		0.5	%
Load Regulation	$V_{IN}=V_{OUT}+1V, 10mA \leq I_{OUT} \leq I_{FULLLOAD}$	0.2		1	%
$\Delta V/\Delta T$	$V_{OUT}$ Temp Coefficient	<b>13</b>		<b>100</b>	ppm/°C
Dropout Voltage (Note 1, except 1.8V)	$I_{OUT}=100mA$ $I_{OUT}=750mA$ $I_{OUT}=1.5A$	70 230 390		<b>200</b> <b>600</b>	mV
Ground Current (Note 3)	$I_{OUT}=750mA, V_{IN}=V_{OUT}+1V$ $I_{OUT}=1.5A$	12 45		<b>25</b>	mA
Ground Pin Current at Dropout	$V_{IN}=0.1V$ less than specified $V_{OUT}$ , $I_{OUT}=10mA$	0.9			mA
Current Limit	$V_{OUT}=0V$ (Note 2)	2.2	1.7		A
Output Noise Voltage (10Hz to 100kHz)	$C_L=10\mu F$ $I_L=100mA$ $C_L=33\mu F$	400 260			$\mu V_{RMS}$
Reference Voltage	Adjustable version only	1.240	1.228 <b>1.215</b>	1.252 <b>1.265</b>	V
Reference Voltage	Adjustable version only (Note 8)		1.203	1.277	
Adjust Pin Bias Current		40		80 <b>120</b>	nA
Reference Voltage Temp. Coeff.	(Note 4)	13			ppm/°C
Adjust Pin Bias Current Temp. Coeff.		0.1			nA/°C

## ELECTRICAL CHARACTERISTICS

at  $V_{IN} = V_{OUT} + 1V$  and  $I_{OUT} = 10mA$ ,  $C_{IN} = 6.8\mu F$ ,  $C_{OUT} = 10\mu F$ ,  $T_A = 25^\circ C$ , unless otherwise specified. The Boldface applies over the junction temperature range. Adjustable versions are set to 5.0V.

PARAMETER	CONDITIONS	TYP	MIN	MAX	UNITS
<b>FLAG OUTPUT (ERROR COMPARATOR)</b>		<b>SPX29150/29151/29153</b>			
Output Leakage Current	$V_{OH} = 16V$	0.1		1 2	$\mu A$
Output Low Voltage	Device set for 5V, $V_{IN} = 4.5V$ , $I_{OL} = 250\mu A$	200		300 400	mV
Upper Threshold Voltage	Device set for 5V, (Note 5)	60	40 25		mV
Lower Threshold Voltage	Device set for 5V, (Note 5)	75		95 140	mV
Hysteresis	Device set for 5V, (Note 5)	15			mV
<b>ENABLE Input</b>		<b>SPX29151/29152</b>			
Input Logic Voltage Low (OFF) High (ON)	$V_{IN} < 10V$		2.4	0.8	V
ENABLE Input Pin	$V_{EN} = 16V$	100		600 750	$\mu A$
	$V_{EN} = 0.8V$			1 2	
Regulator Output Current in Shutdown	(Note 6)	10		500	$\mu A$
Thermal Resistance	TO-200 Junction to Case, at Tab	3			$^\circ C/W$
	TO-220 Junction to Ambient	60			
	TO-263 Junction to Case, at Tab	3			
	TO-263 Junction to Ambient	60			

### NOTES:

Note 1: Dropout voltage is defined as the input to output differential when the output voltage drops to 99% of its nominal value.

Note 2:  $V_{IN} = V_{OUT} (\text{NOMINAL}) + 1V$ . For example, use  $V_{IN} = 4.3V$  for a 3.3V regulator. Employ pulse-testing procedures to minimize temperature rise.

Note 3: Ground pin current is the regulator quiescent current. The total current drawn from the source is the sum of the load current to the ground current.

Note 4: Thermal regulation is defined as the change in the output voltage at a time T after a change in power dissipation is applied, excluding load or line regulation effects.

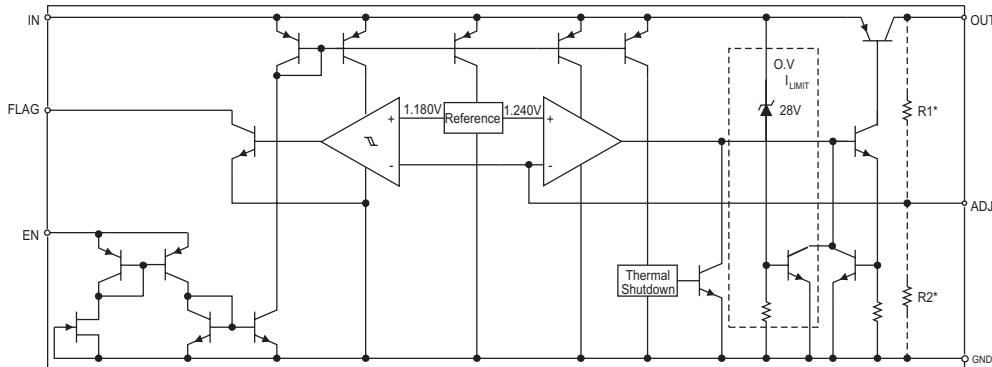
Note 5: Comparator threshold is expressed in terms of a voltage differential at the Adjust terminal below the nominal reference voltage measured 6V input. To express these thresholds in terms of output voltage change, multiply the error amplifier gain =  $V_{OUT}/V_{REF} = (R1 + R2)/R2$ . For example, at a programmable output voltage of 5V, the Error output is guaranteed to go low when the output drops by  $95mV \times 5V / 1.240V = 38mV$ . Threshold remain constant as a percent of  $V_{OUT}$  as  $V_{OUT}$  is varied, with the dropout warning occurring at typically 5% below nominal, 7.7% guaranteed.

Note 6:  $V_{EN} \leq 0.8V$  and  $V_{IN} \leq 16V$ ,  $V_{OUT} = 0$ .

Note 7: Maximum positive supply voltage of 20V must be of limited duration ( $< 100m_s$ )  $< 1\%$ . The maximum continuous supply voltage is 16V.

Note 8:  $V_{REF} \leq V_{OUT} \leq (V_{IN} - 1)$ ,  $2.5V \leq V_{IN} \leq 16V$ ,  $10mA \leq I_L \leq I_{FL}$ ,  $T_J < T_{Jmax}$ .

## BLOCK DIAGRAM



# TYPICAL PERFORMANCE CHARACTERISTICS

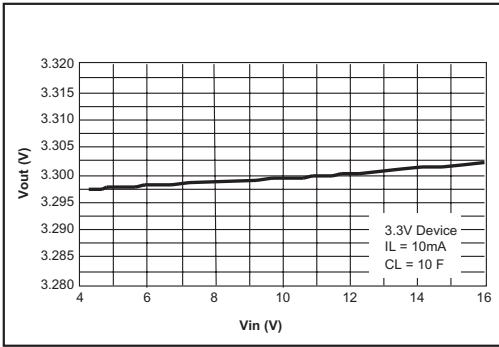


Figure 3. Line Regulation

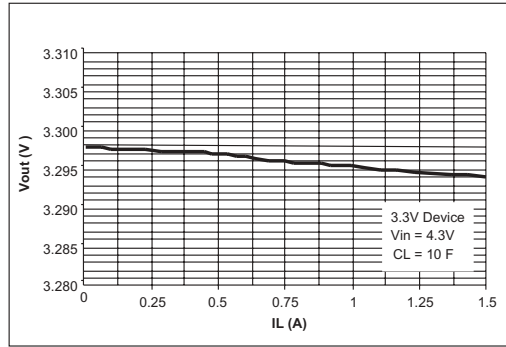


Figure 4. Load Regulation

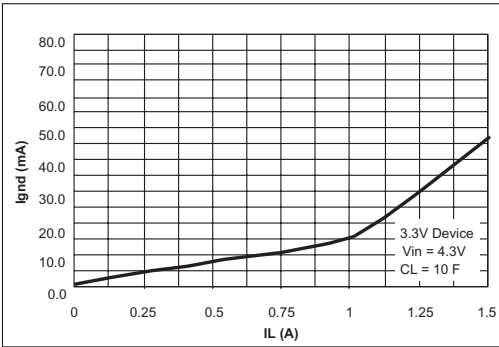


Figure 5. Ground Current vs Load Current

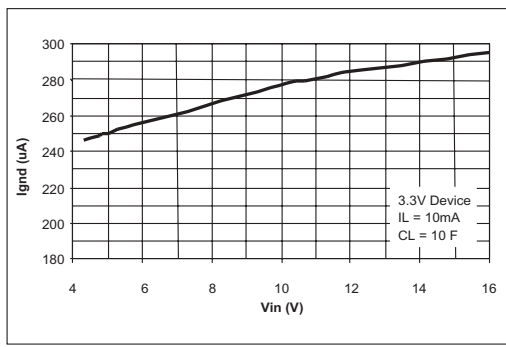


Figure 6. Ground Current vs Input Voltage

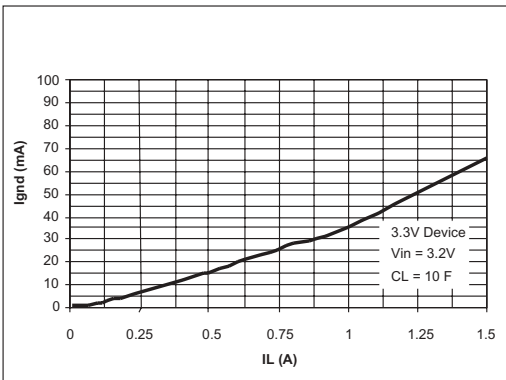


Figure 7. Ground Current vs Load Current in Dropout

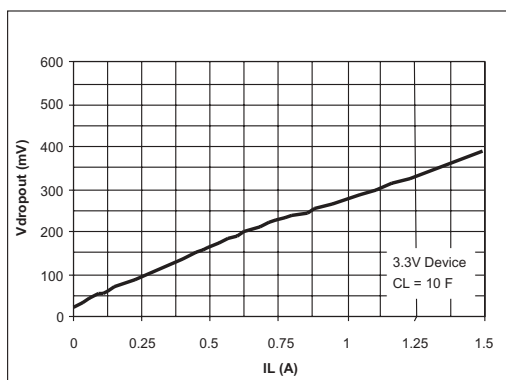
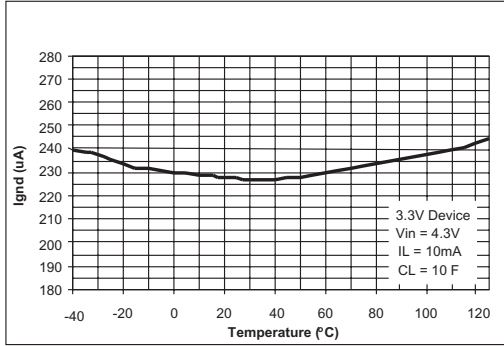
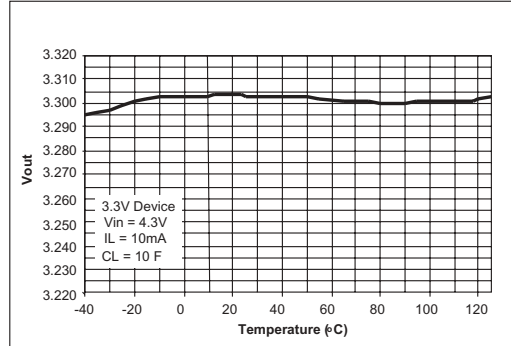


Figure 8. Dropout Voltage vs Load Current

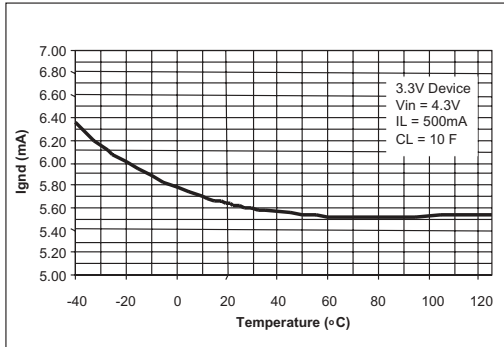
# TYPICAL PERFORMANCE CHARACTERISTICS



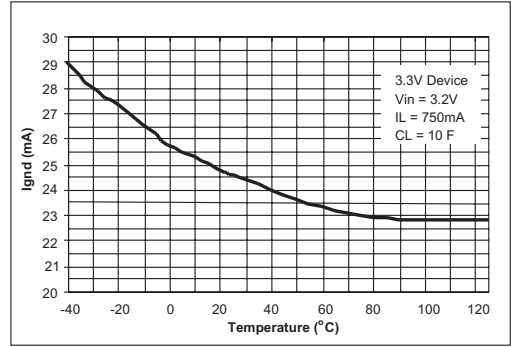
**Figure 9. Ground Current vs Temperature at  $I_{LOAD}=10mA$**



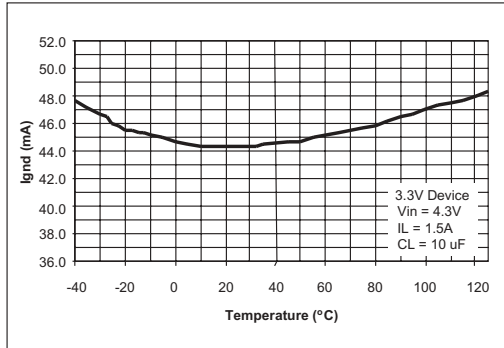
**Figure 10. Output Voltage vs Temperature at  $I_{LOAD}=10mA$**



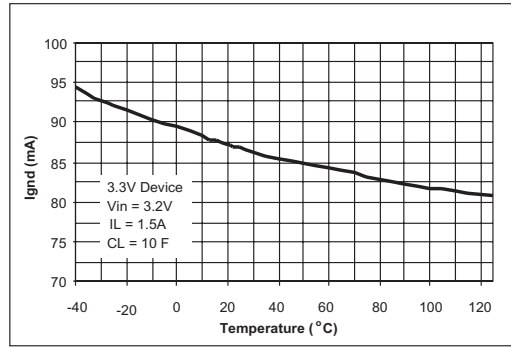
**Figure 11. Ground Current vs Temperature at  $I_{LOAD}=500mA$**



**Figure 12. Output Voltage vs Temperature in Dropout at  $I_{LOAD}=750mA$**

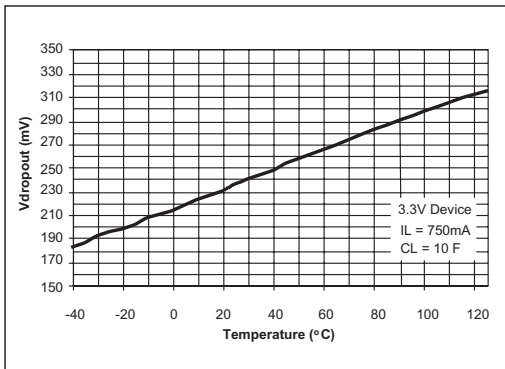


**Figure 13. Ground Current vs Temperature at  $I_{LOAD}=1.5A$**

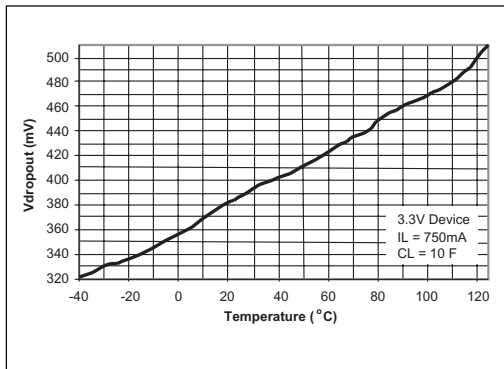


**Figure 14. Output Current vs Temperature in Dropout at  $I_{LOAD}=1.5A$**

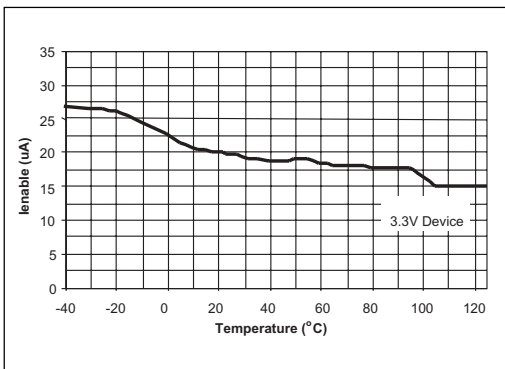
## TYPICAL PERFORMANCE CHARACTERISTICS



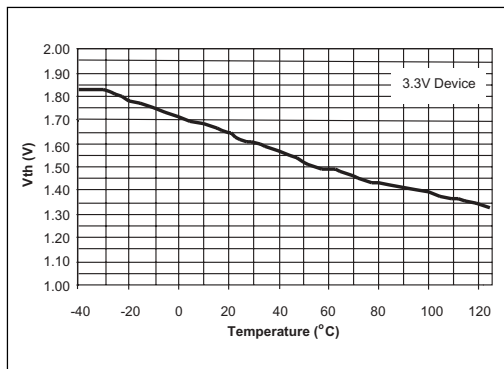
**Figure 15. Dropout Voltage vs Temperature at  $I_{LOAD} = 750mA$**



**Figure 16. Dropout Voltage vs Temperature at  $I_{LOAD} = 1.5A$**



**Figure 17. ENABLE Current vs Temperature at  $V_{EN} = 16V$**



**Figure 18. ENABLE Threshold vs Temperature**

The SPX29150/51/52/53 incorporates protection against over-current faults, reversed load insertion, over temperature operation, and positive and negative transient voltage.

**Thermal Considerations**

Although the SPX29150/51/52/53 offers limiting circuitry for overload conditions, it is still necessary to insure that the maximum junction temperature is not exceeded in the application. Heat will flow through the lowest resistance path, the junction-to-case path. In order to insure the best thermal flow of the component, proper mounting is required. Consult the heatsink manufacturer for thermal resistance and heat sink design.

**TO-220 Design Example:**

Assume that  $V_{IN} = 10V$ ,  $V_{OUT} = 5V$ ,  $I_{OUT} = 1.5A$ ,  $T_A = 50^{\circ}C$ ,  $\theta_{HA} = 1^{\circ}C/W$ ,  $\theta_{CH} = 2^{\circ}C/W$ , and  $\theta_{JC} = 3^{\circ}C/W$ , where:

- $T_A$  = ambient temperature,
- $\theta_{HA}$  = heatsink to ambient thermal resistance
- $\theta_{CH}$  = case to heatsink thermal resistance
- $\theta_{JC}$  = junction to case thermal resistance

The power calculated under these conditions is:

$$P_D = (V_{IN} - V_{OUT}) * I_{OUT} = 7.5W.$$

And the junction temperature is calculated as

$$T_J = T_A + P_D * (\theta_{HA} + \theta_{CH} + \theta_{JC}) \text{ or}$$

$$T_J = 50 + 7.5 * (1+2+3) = 95^{\circ}C$$

Reliable operation is insured.

**Capacitor Requirements**

The output capacitor is needed to insure stability and minimize the output noise. The value of the capacitor varies with the load. However, a minimum value of 10 $\mu$ F aluminum capacitor will guarantee stability over all load conditions. A tantalum capacitor is recommended if a faster load transient response is needed. If the power source has a high AC impedance, a 0.1 $\mu$ F ceramic capacitor between input & ground is recommended.

**Minimum Load Current**

To ensure a proper behavior of the regulator under light load, a minimum load of 5mA for SPX29150/51/52/53 is required.

**Typical Application Circuits**

Figure 19 represents a typical fixed output regulator. Figure 20 represents an adjustable regulator. The values of R1 and R2 set the output voltage value as follows:  $V_{OUT} = V_{REF} * [1 + (R1/R2)]$ . For best results, the total series resistance should be small enough to pass a minimum regulator load current of 5mA. A minimum value of 10k $\Omega$  is recommended for R2 with a range between 10k $\Omega$  and 47k $\Omega$ .

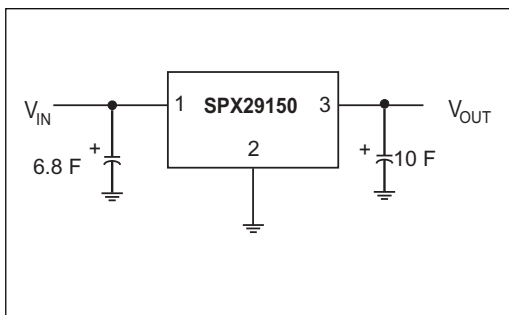


Figure 19. Fixed Output Linear Regulator

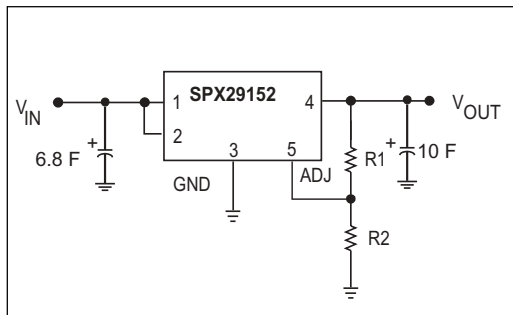
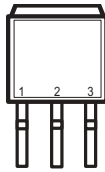


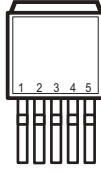
Figure 20. Adjustable Output Linear Regulator

TO-263-3 Package (T)



$V_{IN}$  GND  $V_{OUT}$   
Front View

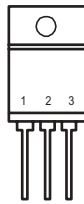
TO-263-5 Package (T5)



Top View

SPX29151	SPX29152	SPX29153
1) ENABLE	1) ENABLE	1) FLAG
2) INPUT	2) INPUT	2) INPUT
3) GND	3) GND	3) GND
4) OUTPUT	4) OUTPUT	4) OUTPUT
5) FLAG	5) ADJUST	5) ADJUST

TO-220-3 Package (U)



$V_{IN}$  GND  $V_{OUT}$   
Front View

TO-220-5 Package (U5)



Top View

SPX29151	SPX29152	SPX29153
1) ENABLE	1) ENABLE	1) FLAG
2) INPUT	2) INPUT	2) INPUT
3) GND	3) GND	3) GND
4) OUTPUT	4) OUTPUT	4) OUTPUT
5) FLAG	5) ADJUST	5) ADJUST

\*Tab is internally connected to GND



**ORDERING INFORMATION**

<b>PART NUMBER</b>	<b>ACCURACY</b>	<b>OUTPUT VOLTAGE</b>	<b>PACKAGE</b>
SPX29150U-1.8	1.0%	1.8V	3 lead TO-220
SPX29150U-2.5	1.0%	2.5V	3 lead TO-220
SPX29150U-3.3	1.0%	3.3V	3 lead TO-220
SPX29150U-5.0	1.0%	5.0V	3 lead TO-220
SPX29150T-1.8	1.0%	1.8V	3 lead TO-263
SPX29150T-1.8/TR	1.0%	1.8V	3 lead TO-263
SPX29150T-2.5	1.0%	2.5V	3 lead TO-263
SPX29150T-2.5/TR	1.0%	2.5V	3 lead TO-263
SPX29150T-3.3	1.0%	3.3V	3 lead TO-263
SPX29150T-3.3/TR	1.0%	3.3V	3 lead TO-263
SPX29150T-5.0	1.0%	5.0V	3 lead TO-263
SPX29150T-5.0/TR	1.0%	5.0V	3 lead TO-263
SPX29151U5-1.8	1.0%	1.8V	5 lead TO-220
SPX29151U5-2.5	1.0%	2.5V	5 lead TO-220
SPX29151U5-3.3	1.0%	3.3V	5 lead TO-220
SPX29151U5-5.0	1.0%	5.0V	5 lead TO-220
SPX29151T5-1.8	1.0%	1.8V	5 lead TO-263
SPX29151T5-1.8/TR	1.0%	1.8V	5 lead TO-263
SPX29151T5-2.5	1.0%	2.5V	5 lead TO-263
SPX29151T5-2.5/TR	1.0%	2.5V	5 lead TO-263
SPX29151T5-3.3	1.0%	3.3V	5 lead TO-263
SPX29151T5-3.3/TR	1.0%	3.3V	5 lead TO-263
SPX29151T5-5.0	1.0%	5.0V	5 lead TO-263
SPX29151T5-5.0/TR	1.0%	5.0V	5 lead TO-263
SPX29152T5	1.0%	Adj	5 lead TO-263
SPX29152T5/TR	1.0%	Adj	5 lead TO-263
SPX29152U5	1.0%	Adj	5 lead TO-220
SPX29153T5	1.0%	Adj	5 lead TO-263
SPX29153T5/TR	1.0%	Adj	5 lead TO-263
SPX29153U5	1.0%	Adj	5 lead TO-220

Available in lead free packaging. To order add "-L" suffix to part number.

Example: SPX29153T5/TR = standard; SPX29153T5-L/TR = lead free



**ANALOG EXCELLENCE**

**Sipex Corporation**

**Headquarters and  
Sales Office**  
233 South Hillview Drive  
Milpitas, CA 95035  
TEL: (408) 934-7500  
FAX: (408) 935-7600

Sipex Corporation reserves the right to make changes to any products described herein. Sipex does not assume any liability arising out of the application or use of any product or circuit described herein; neither does it convey any license under its patent rights nor the rights of others.