

W88113C

ATAPI CD-ROM

Decoder & Controller

W88113C Data Sheet Revision History

| | Pages | Dates | Version | Version on Web | Main Contents |
|----|---|---------|---------|----------------|-----------------------|
| 1 | N/A | 05/1998 | 0.50 | | First published |
| 2 | 16,18,53,54,56,61,64,67,70,71,72,73,p86(add),91,92,94,95,96 | 12/1998 | 0.60 | | for W88113C version F |
| 3 | 1,5,14,21,46,66 | 03/1999 | 0.61 | | text error fix |
| 4 | | | | | |
| 5 | | | | | |
| 6 | | | | | |
| 7 | | | | | |
| 8 | | | | | |
| 9 | | | | | |
| 10 | | | | | |

Please note that all data and specifications are subject to change without notice. All the trade marks of products and companies mentioned in this data sheet belong to their respective owners.

LIFE SUPPORT APPLICATIONS

These products are not designed for use in life support appliances, devices, or systems where malfunction of these products can reasonably be expected to result in personal injury. Winbond customers using or selling these products for use in such applications do so at their own risk and agree to fully indemnify Winbond for any damages resulting from such improper use or sales.

TABLE OF CONTENTS

| | |
|--|-----------|
| 1. OVERVIEW | 1 |
| 1.1 FEATURES | 1 |
| 1.1.1 Host Interface | 1 |
| 1.1.2 DSP Interface..... | 1 |
| 1.1.3 Microcontroller Interface | 1 |
| 1.1.4 DRAM Interface | 2 |
| 1.1.5 Audio Playback Interface | 2 |
| 1.1.6 Miscellaneous | 2 |
| 1.2 BLOCK DIAGRAM..... | 3 |
| 1.3 PIN CONFIGURATION | 4 |
| 1.4 PIN DESCRIPTION..... | 5 |
| 1.5 PIN TABLE | 8 |
| 1.6 DEFINITIONS..... | 11 |
| 2. REGISTERS DESCRIPTION | 13 |
| 3. REGISTER TABLE | 70 |
| 4. CHARACTERISTICS | 74 |
| 5. APPLICATION NOTES..... | 75 |
| 5.1 DRAM INTERFACE..... | 75 |
| 5.1.1 Memory Layout..... | 75 |
| 5.1.2 Block Configuration..... | 76 |
| 5.1.3 Linear Address v.s. Block-Offset Address | 78 |
| 5.1.4 16-bit DRAM..... | 79 |
| 5.1.5 EDO DRAM..... | 79 |



| | |
|--|-----------|
| 5.2 MICROCONTROLLER INTERFACE..... | 80 |
| 5.2.1 Direct Register Addressing | 80 |
| 5.2.2 General I/O..... | 81 |
| 5.2.3 Programmable System Clock | 81 |
| 5.3 HOST INTERFACE..... | 83 |
| 5.3.1 Ultra DMA Mode Setting..... | 83 |
| 5.3.2 Ultra DMA Data-out..... | 83 |
| 5.3.3 Ultra DMA Error Handling..... | 84 |
| 5.3.4 Ultra DMA Data-In Transfer Diagram..... | 84 |
| 5.3.5 Data-in Transfer Flowchart Example | 85 |
| 5.3.6 BSY Flag Control | 86 |
| 5.3.7 Pin HIRQ Control | 86 |
| 5.4 DECODER LOGIC..... | 87 |
| 5.4.1 Sync Detection/Insertion | 87 |
| 5.4.2 Descramble..... | 87 |
| 5.4.3 Disk-Monitor Mode | 87 |
| 5.4.4 Parallel ECC Correction | 87 |
| 5.4.5 EDC Checking..... | 88 |
| 5.4.6 Real Time EDC Checking..... | 88 |
| 5.4.7 Decoding Sequence Model..... | 88 |
| 5.4.8 Disc Format Selection..... | 88 |
| 5.4.9 CD-DA data & Q-channel Extraction | 89 |
| 5.4.10 Target Search..... | 90 |
| 5.4.11 Automatic Header Comparison | 90 |
| 5.4.12 Status Collection..... | 90 |
| 5.4.13 Decoder Processing Flow | 91 |
| 5.4.14 Buffer-Independent-Correction | 91 |
| 5.4.15 Remove Frequent SRIB & Automatic Cache Management | 92 |
| 5.5 AUDIO-PLAYBACK | 94 |
| 5.5.1 Configuration Phase..... | 94 |
| 5.5.2 Playback Phase | 94 |
| 5.5.3 IEC-958 Digital Audio Output..... | 94 |
| 5.5.4 Audio Playback Flowchart Example..... | 95 |
| 6. ORDERING INSTRUCTION..... | 96 |
| 7. HOW TO READ THE TOP MARKING | 96 |
| 8. PACKAGE DIMENSIONS | 97 |



ATAPI CD-ROM DECODER & CONTROLLER

1. OVERVIEW

1.1 Features

1.1.1 Host Interface

- Support ATAPI CD-ROM standard (SFF 8020)
- Ultra DMA/33 support to achieve high throughput and data integrity
- 32-byte Data FIFO to increase data throughput
- Support Block-offset transfer and Linear Address transfer
- Automatic ATAPI sequence handling
- Automatic data transfer trigger and cache management

1.1.2 DSP Interface

- Supports CD-ROM, CD-ROM/XA, CD-I, Video-CD, Photo-CD, and CD-Plus formats
- Supports various types of microprocessors and DSPs
- Supports CD-ROM data descrambling
- Supports both real-time correction and buffer-independent correction
- One byte error correction per P-word and Q-word
- Supports error detection of CD-ROM data
- Automatic repeated error correction
- Real time EDC checking logic
- Q-channel extraction by hardware to support precise CD-DA data reading
- Using pin BCK as subcode reference clock
- Target Search and Status Flag Collection to minimize micro-processor overhead

1.1.3 Microcontroller Interface

- Direct Register Addressing (default) and Indirect Register Addressing support
- Programmable ALE pin
- Support 2 programmable general I/O ports and one programmable general input port



1.1.4 DRAM Interface

- Various DRAMs support (128K x 8, 256K x 8, 1M x 8, 64K x 16, 128K x 16, 256K x 16)
- Supports ring-control-register to add flexibility of DRAM control
- FPG/EDO DRAM support
- Programmable DRAM timing
- Programmable refresh timing

1.1.5 Audio Playback Interface

- Audio playback in CAV mode
- Programmable audio data output pin
- Programmable audio reference clock
- Flexible left-right mute and volume control
- IEC-958 Digital Audio output

1.1.6 Miscellaneous

- Flexible power management
- Programmable internal system clock (up to 4 times fast of crystal input)
- Clock output with various frequency
- 100-pin QFP/LQFP package

1.2 Block Diagram

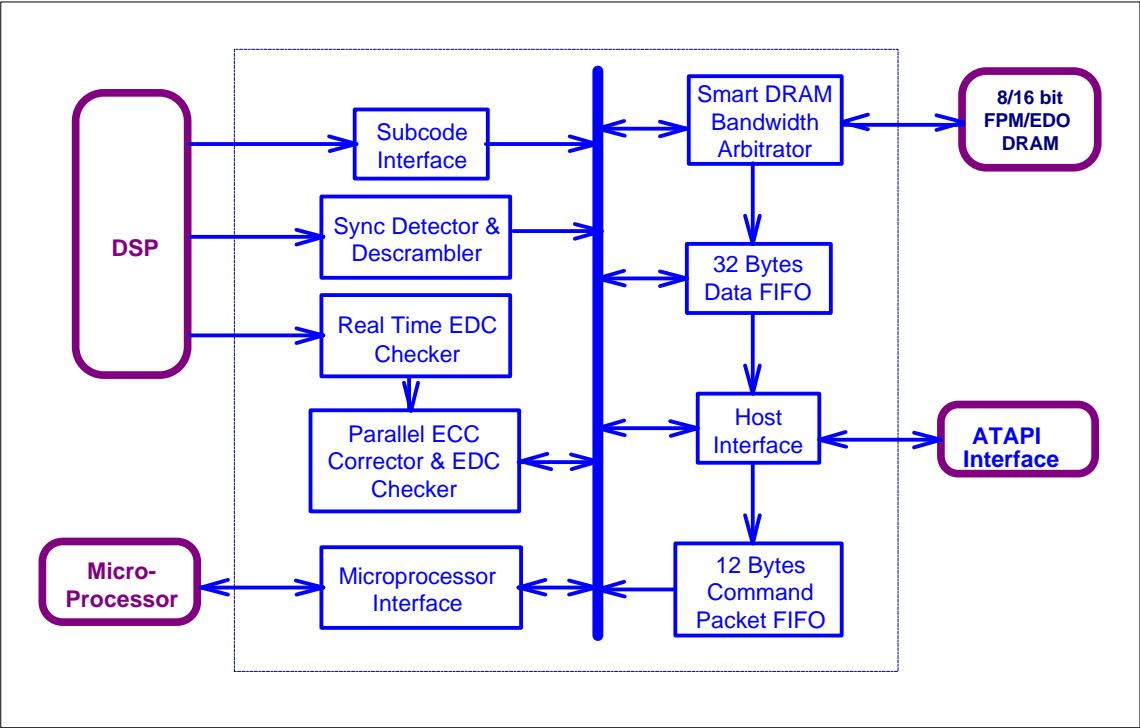

1.3 Pin configuration

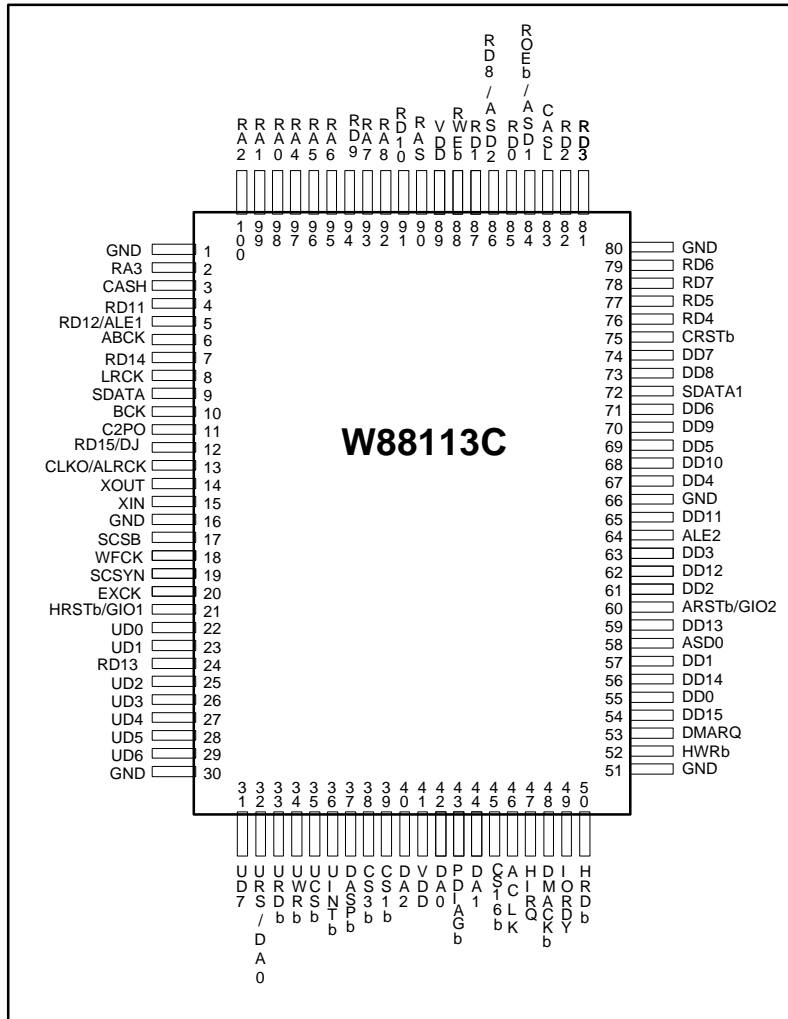



1.4 Pin Description

The following convention is used in the pin description table below:

- (I) denotes an input
- (O) denotes an output
- (OZ) denotes a tri-state output
- (OD) denotes an open-drain output
- (I/O) denotes a bi-directional signal

Miscellaneous Pins

| NAME | NO. | TYPE | PIN DESCRIPTION |
|------------|--------------------------|------|---|
| RD15/DJ | 12 | I/O | RAM Data 15/Drive Jumper |
| CLKO/ALRCK | 13 | O | Clock Output/Audio LR Clock |
| XIN | 15 | I | Crystal input/output - Normally, XIN and XOUT are connected to a crystal. |
| XOUT | 14 | O | |
| HRSTb/GIO1 | 17 | I | Host Reset - A low active input signal |
| ARSTb/GIO2 | 60 | OD | ATAPI Reset - A low active output signal. |
| CRSTb | 75 | I | Chip Reset - A low-active input signal. |
| VDD | 41, 89 | | Power Supply Pin - 5.0V \pm 5% |
| GND | 1, 16, 30, 51, 66, 80 | | Ground Pin |

Micro-controller Interface

| NAME | NO. | TYPE | PIN DESCRIPTION |
|------------------|-----------------------------------|------|---|
| UD[7:0] | 22, 23, 25, 26, 27, 28, 29, 31 | I/OZ | Microprocessor Data Bus - Bi-directional processor data lines. |
| URS/GIN3/D AO | 32 | I | Register Select - To select address register or internal register. |
| URDb | 33 | I | Microprocessor Read Strobe - A low-active input signal. |
| UWRb | 34 | I | Microprocessor Write Strobe - A low-active input signal. |
| UCSb | 35 | I | Microprocessor Chip Select - A low-active input signal. |
| RD12/ALE1 | 5 | I | RAM data 12/Address Latch Enable 1 |
| ALE2 | 64 | I | Address Latch Enable 2 |
| UINtb | 36 | OD | Microprocessor Interrupt - A low-active output signal that can be externally wired-OR with other interrupt sources. |



Audio Interface

| NAME | NO. | TYPE | PIN DESCRIPTION |
|------------|-----|------|------------------------|
| ABCK | 6 | O | Audio Bit Clock |
| CLKO/ALRCK | 13 | O | Audio Left/Right Clock |
| ACLK | 46 | I | Audio Reference Clock |
| ASD0 | 58 | O | Audio Serial Data 0 |
| ROEB/ASD1 | 84 | O | Audio Serial Data 1 |
| RD8/ASD2 | 86 | O | Audio Serial Data 2 |

Host Interface

| NAME | NO. | TYPE | PIN DESCRIPTION |
|----------|--|------|---|
| DD[15:0] | 54, 56, 59, 62, 65, 68, 70, 73, 74, 71, 69, 67, 63, 61, 57, 55 | I/OZ | Host Data Bus - Signals enable data transfer between the host and W88113A. |
| DA[2:0] | 40, 44, 42 | I | Host Address Bus - Signals to access various ATAPI registers. |
| DASPb | 37 | I/OD | Drive Active/Drive 1 Present - A time-multiplexed signal indicating whether a drive is active, or Drive 1 is present. |
| CS3b | 38 | I | Host Chip Select 1 - A low-active input signal used to select the host Control Block Registers. |
| CS1b | 39 | I | Host Chip Select 0 - A low-active input signal used to select the host Command Block Registers. |
| PDIAGb | 43 | I/OD | Passed Diagnostics - A signal asserted by Drive 1 to indicate to Drive 0 that diagnostic is completed. |
| CS16b | 45 | OD | 16-bit I/O Select - A low-active output signal to indicate a 16-bit data transfer. |
| HIRQ | 47 | OZ | Host Interrupt - A signal to request an interrupt service from host. |
| DMACKb | 48 | I | DMA Acknowledge - A low-active input signal used for DMA transfer by the host when DMARQ is ready. |
| IORDY | 49 | OZ | I/O Channel Ready - When device is not ready for a data transfer request, this signal is negated for extension of the host data transfer cycle within any host register access. |
| HRDb | 50 | I | Host I/O Read - A low-active read strobe signal. |
| HWRb | 52 | I | Host I/O Write - A low-active write strobe signal. |
| DMARQ | 53 | OZ | DMA Request - A high-active signal asserted for DMA data transfer when device is ready to transfer data to or from the host. |

DSP Interface

| NAME | NO. | TYPE | PIN DESCRIPTION |
|--------|-----|------|---|
| LRCK | 8 | I | L/R Channel Clock - Left and right channels are distinguished by this signal. |
| SDATA | 9 | I | Serial Data - Serial data from DSP is received from this input. |
| SDATA1 | 72 | I | Serial Data - Second Serial data from DSP is received from this input. |
| BCK | 10 | I | Bit Clock - Bit clock from DSP is received from this input. |
| C2PO | 11 | I | C2 Pointer - C2 error flag from DSP is received from this input. |

Subcode Interface

| NAME | NO. | TYPE | PIN DESCRIPTION |
|-------|-----|------|---|
| SCSD | 17 | I | Subcode Serial Data - Subcode serial data from DSP is received from this input. |
| WFCK | 18 | I | Write Frame Clock - Write frame clock from DSP is received from this input. |
| SCSYN | 19 | I | Subcode Sync - Subcode sync from DSP is received from this input. |
| EXCK | 20 | I/O | External Clock - A pin programmed as input or output to supply bit clock for subcode. |

External RAM Interface

| NAME | NO. | TYPE | PIN DESCRIPTION |
|----------|---|------|---|
| ROEb | 84 | O | External RAM Output Enable - A low-active output signal |
| RWEb | 88 | O | External RAM Write Enable - A low-active output signal |
| RD[15:0] | 12, 7, 24, 5, 4, 91, 94, 86, 78, 79, 77, 76, 81, 82, 87, 85 | I/O | RAM Data Bus - Data bus for external RAM. |
| RA[9:0] | 91, 92, 93, 95, 96, 97, 2, 100, 99, 98 | O | RAM Address Bus - Address bus for external RAM. |
| CASH/L | 3, 83 | O | External RAM Column Address Strobe |
| RAS | 90 | O | External RAM Row Address Strobe |

1.5 Pin Table

| NO. | NAME | TYPE | DESCRIPTION | REMARK |
|-----|------------|------|---------------------------------|---------|
| 1 | GND | P | Ground | |
| 2 | RA3 | O | RAM Address | 6mA |
| 3 | CASH | O | High Byte Column Address Strobe | 6mA |
| 4 | RD11 | I/O | RAM Data | 6mA, PU |
| 5 | RD12/ALE1 | I/O | RAM Data/Address Latch Enable | 6mA, PU |
| 6 | ABCK | O | Audio Bit Clock | 6mA, PU |
| 7 | RD14 | I/O | RAM Data | 6mA, PU |
| 8 | LRCK | I | L/R Channel Clock | 6mA, PU |
| 9 | SDATA | I | DSP Serial Data | |
| 10 | BCK | I | DSP Bit Clock | |
| 11 | C2PO | I | DSP C2 Pointer | |
| 12 | RD15/DJ | I/O | RAM Data/Drive Jumper | 6mA, PU |
| 13 | CLKO/ALRCK | O | Clock Output/Audio LR Clock | 6mA, PU |
| 14 | XOUT | O | Crystal Output | |
| 15 | XIN | I | Crystal Input | |
| 16 | GND | P | Ground | |
| 17 | SCSB | I | Subcode Serial Data | |
| 18 | WFCK | I | Write Frame Clock | |
| 19 | SCSYN | I | Subcode Sync | |
| 20 | EXCK | I/O | Subcode External Clock | 6mA, PU |
| 21 | HRSTb | I/OD | Host Reset/GIO1 | 6mA, PU |
| 22 | UD0 | I/O | uP Data | 6mA, PU |
| 23 | UD1 | I/O | uP Data | 6mA, PU |
| 24 | RD13 | I/O | RAM Data | 6mA, PU |
| 25 | UD2 | I/O | uP Data | 6mA, PU |
| 26 | UD3 | I/O | uP Data | 6mA, PU |
| 27 | UD4 | I/O | uP Data | 6mA, PU |
| 28 | UD5 | I/O | uP Data | 6mA, PU |
| 29 | UD6 | I/O | uP Data | 6mA, PU |
| 30 | GND | P | Ground | |



1.5 Pin Table, continued

| NO. | NAME | TYPE | DESCRIPTION | REMARK |
|-----|--------------|------|--|----------|
| 31 | UD7 | I/O | uP Data | 6mA, PU |
| 32 | URS/DAO/GIN3 | I/O | uP Register Select/Digital Audio Output 0 General Input 3 | 6mA |
| 33 | URDb | I | uP Read Strobe | |
| 34 | UWRb | I | uP Write Strobe | |
| 35 | UCSb | I | uP Chip Select | |
| 36 | UINtb | OD | uP Interrupt | 12mA |
| 37 | DASpb | I/OD | Drive Active | 12mA, PU |
| 38 | CS3b | I | Host Chip Select 1 | PU |
| 39 | CS1b | I | Host Chip Select 0 | PU |
| 40 | DA2 | I | Host Address | PU |
| 41 | VDD | P | Power Supply | |
| 42 | DA0 | I | Host Address | PU |
| 43 | PDIAGb | I/OD | Passed Diagnostics | 12mA, PU |
| 44 | DA1 | I | Host Address | PU |
| 45 | CS16b | OD | 16-bit I/O Select | 12mA |
| 46 | ACLK | I | Audio Reference Clock | |
| 47 | HIRQ | O | Host Interrupt | 12mA |
| 48 | DMACKb | I | DMA Acknowledge | PU |
| 49 | IORDY | O | I/O Channel Ready | 12mA |
| 50 | HRDb | I | Host Read Strobe | PU |
| 51 | GND | P | Ground | |
| 52 | HWRb | I | Host Write Strobe | PU |
| 53 | DMARQ | O | DMA Request | 12mA |
| 54 | DD15 | I/O | Host Data | 12mA, PU |
| 55 | DD0 | I/O | Host Data | 12mA, PU |
| 56 | DD14 | I/O | Host Data | 12mA, PU |
| 57 | DD1 | I/O | Host Data | 12mA, PU |
| 58 | ASD0 | O | Audio Serial Data 0 | 6mA |
| 59 | DD13 | I/O | Host Data | 12mA, PU |
| 60 | ARSTb | I/OD | ATAPI Reset/GIO2 | 6mA, PU |



1.5 Pin Table, continued

| NO. | NAME | TYPE | DESCRIPTION | REMARK |
|-----|-----------|------|-------------------------------------|----------|
| 61 | DD2 | I/O | Host Data | 12mA, PU |
| 62 | DD12 | I/O | Host Data | 12mA, PU |
| 63 | DD3 | I/O | Host Data | 12mA, PU |
| 64 | ALE2 | I | Address Latch Enable | |
| 65 | DD11 | I/O | Host Data | 12mA, PU |
| 66 | GND | P | Ground | |
| 67 | DD4 | I/O | Host Data | 12mA, PU |
| 68 | DD10 | I/O | Host Data | 12mA, PU |
| 69 | DD5 | I/O | Host Data | 12mA, PU |
| 70 | DD9 | I/O | Host Data | 12mA, PU |
| 71 | DD6 | I/O | Host Data | 12mA, PU |
| 72 | SDATA1 | I | DSP Serial Data 1 | |
| 73 | DD8 | I/O | Host Data | 12mA, PU |
| 74 | DD7 | I/O | Host Data | 12mA, PU |
| 75 | CRSTb | I | Chip Reset | PU |
| 76 | RD4 | I/O | RAM Data | 6mA, PU |
| 77 | RD5 | I/O | RAM Data | 6mA, PU |
| 78 | RD7 | I/O | RAM Data | 6mA, PU |
| 79 | RD6 | I/O | RAM Data | 6mA, PU |
| 80 | GND | P | Ground | |
| 81 | RD3 | I/O | RAM Data | 6mA, PU |
| 82 | RD2 | I/O | RAM Data | 6mA, PU |
| 83 | CASL | O | Low Byte Column Address Strobe | 6mA |
| 84 | ROEB/ASD1 | O | RAM Read Strobe/Audio Serial Data 1 | 6mA, PU |
| 85 | RD0 | I/O | RAM Data | 6mA, PU |
| 86 | RD8/ASD2 | I/O | RAM Data/Audio Serial Data 2 | 6mA, PU |
| 87 | RD1 | I/O | RAM Data | 6mA, PU |
| 88 | RWEb | O | RAM Write Strobe | 6mA |
| 89 | VDD | P | Power Supply | |
| 90 | RAS | O | Row Address Strobe | 6mA |



1.5 Pin Table, continued

| NO. | NAME | TYPE | DESCRIPTION | REMARK |
|-----|----------|------|----------------------|---------|
| 91 | RD10/RA9 | I/O | RAM Data/RAM Address | 6mA, PU |
| 92 | RA8 | O | RAM Address | 6mA, PU |
| 93 | RA7 | O | RAM Address | 6mA, PU |
| 94 | RD9 | I/O | RAM Data | 6mA, PU |
| 95 | RA6 | O | RAM Address | 6mA |
| 96 | RA5 | O | RAM Address | 6mA |
| 97 | RA4 | O | RAM Address | 6mA |
| 98 | RA0 | O | RAM Address | 6mA |
| 99 | RA1 | O | RAM Address | 6mA |
| 100 | RA2 | O | RAM Address | 6mA |

1.6 Definitions

Asserted/Activated:

Asserted and activated mean that a signal is driven to its true state.

Block:

This term refers to the data in one logical block. The block size depends on the parameter of packet command.

Block-Offset/Linear Address:

The block-offset address is an *indirect* mapping to the external RAM. The offset range is limited by the block size. The linear address is a *direct* mapping to the external RAM.

Command Packet (CP):

The command packet is the structure used to communicate commands from a host computer to an ATAPI device. All CD-ROM command packets are 12 bytes in length.

Data-in/Data-out Transfer:

During the data-in transfer, the data is transferred from device to host. During the data-out transfer, the data is transferred from host to drive.



Decrement/Increment:

Decrement means that a value minus 1. Increment means that a value plus 1.

Negated/De-activated:

Negated and de-activated mean that a signal is driven to its false state.

Sector:

This term refers to the data contained by one frame time (1/75s for 1x).

Ultra DMA:

Ultra DMA is a data transfer protocol that applies to the Ultra DMA data burst only.

Ultra DMA burst:

An Ultra DMA burst is defined as the period from an assertion of DMACKb to the subsequent negation of DMACKb when Ultra DMA has been enabled by the host.

Ultra DMA CRC:

Cyclical Redundancy Check is used for the Ultra DMA protocol to check the validity of the data that has been transferred during last Ultra DMA burst.



2. REGISTERS DESCRIPTION

IR - Index Register (read/write)

If *DRA* (5Bh.1) is high, the Index Register is latched at the falling edge of *pin ALE1* (5) or *pin ALE2* (64) depending on the setting of *ALE2* (5Ch.3).

If *DRA* (5Bh.1) is low and *pin URS* (32) is low, the Index Register can be accessed by the microprocessor. The value in IR specifies which internal register to be accessed by microprocessor when *pin URS* (32) is high.

Note that the 4 least significant bits of IR will increment following each read or write to any register except for *PFAR* (00h,r). Since IR does not automatically increment from 00h to 01h, consecutive reads to address 00h will repeatedly read register *PFAR* (00h,r). This feature accelerates read operation of ATAPI Command Packet.

PFAR - Packet FIFO Access Register - (read 00h)

While *SCoD* (20h.2) is high, the ATAPI Command Packet issued from host is received by the 12-byte Packet FIFO. Flag *TENDb* (01h.r6) is used to check if the Packet FIFO is full. The microprocessor can read the ATAPI Command Packet by repeatedly read register *PFAR* (00h,r). Once the FIFO becomes empty, the value FFh will be returned if microprocessor read *PFAR*.

The Packet FIFO can also be used to receive command parameter less than 12 bytes. First, the control bit *SCoD* (20h.2) is set high to select the Packet FIFO to be addressed by the ATAPI Data port. When *DRQ* (37h.3) changes from 0 to 1, the lower 4 bits of *ATBLO* (34h) is latched as the FIFO threshold. Upon the number of bytes in the FIFO reaches the threshold, flag *TENDb* (01h.r6) becomes active-low and flag *FPKT* (30h.r1) becomes active-high. Once *FPKT* becomes high, any data writes to the ATAPI Data port is rejected.

INTCTL - Interrupt Control Register - (write 01h)

Bit 7: PFNEEN - Packet FIFO Not Empty Interrupt Enable

Pin UINTb (36) is activated when *PFNEb*(01h.r7) becomes active-low if this bit is high.

Bit 6: TENDEN - Transfer End Interrupt Enable

Pin UINTb (36) is activated when *TENDb* (01h.r6) becomes active-low if this bit is high. This bit is also automatically enabled if the host issues the Packet Command (A0h) while *HIEN* (2Eh.w7) is high and drive is selected.

Bit 5: SRIEN - Sector Ready Interrupt Enable

Pin UINTb (36) is activated when *SRIb* (01h.r5) becomes active-low if this bit is high. This bit is clear to 0 after chip reset, host reset, firmware reset and decoder reset.



Bits 4, 3, 2: Reserved

Bit 1: DTEN - Data Transfer Enable

Set this bit high enables the data transfer logic. This bit should be set before trigger any data transfer. In order to reduce the interference of microprocessor, this bit is also automatically enabled during the following operation:

- Trigger *ADTT (17h.w2)*
- Host issues ATAPI Packet Command (A0h) while *APKTEN (18h.7)* is enabled and drive is selected

In case of un-recoverable transfer error, setting this bit low will terminate the current data transfer immediately.

Bit 0: Reserved

INTREA - Interrupt Reason Register - (read 01h)

Bit 7: PFNEb - Packet FIFO Not Empty Interrupt Flag

This bit becomes active-low after Packet FIFOs receive any data issued by the host through ATAPI Data port. *Pin UINTb (36)* is activated when this bit becomes active-low if *PFNEEN (01h.w7)* is enabled. This flag is deactivated after the last byte is read by microprocessor through register *PFAR (00h,r)*.

Bit 6: TENDb - Transfer End Interrupt Flag

This bit becomes active-low at the end of data transfers. Flag *TDIR (30h.r5)* and *FPKT (30h.r1)* can be used to determine which type of transfer end occurs. *Pin UINTb (36)* is activated when this bit becomes active-low if *TENDEN (01h.w6)* is enabled.

| TENDb (01h.r6) | TDIR (30h.r5) | FPKT (30h.1) | Transfer End Reason | Acknowledge register |
|----------------|---------------|--------------|----------------------------|--------------------------|
| 0 | 1 | 0 | data-in transfer | DHTACK (0Eh), TACK (07h) |
| 0 | 1 | x | data-out transfer | TACK (07h) |
| 0 | 0 | x | A0 command packet transfer | TACK (07h) |

Bit 5: SR1b - Sector Ready Interrupt Flag

If *RMSRI (5Ch.0)* is low, this bit is used to indicate that one sector is ready to be accessed. If *RMSRI (5Ch.0)* is high, this bit is generated only by *STAERR (80h.r6)*, *BIN0 (80h.r5)*, *DSFULI (80h.r4)*, *LASTBK (80h.r3)*, *LTTI (80h.r2)*, *TNFI (80h.r1)* or *HCEI (80h.r0)*.

Reading register *STAT3 (0Fh,r)*, *LSTA3 (4Bh,r)* or *TARSTA (80h,r)* deactivates this flag.

**Bit 4: HC1b - Host Command Interrupt Flag**

This bit is activated by the following events:

- Host issues ATAPI Soft Reset Command, if *ARSTIEN(2Fh.1)* is enabled
- Host issues command to a non-existent slave drive, if *SHIEN(2Eh.2)* is enabled
- Host issues Execute Drive Diagnostics Command, if *HIIEN(2Eh.7)* is enabled
- *ATAC(2Fh.6)* becomes active-high, if *HIIEN(2Eh.7)* is enabled
- Host set bit SRST in ATAPI Device Control Register, if *HIIEN(2Eh.7)* is enabled

Bit 3: TBSYb - Transfer Busy Flag

This bit becomes active-low when the data transfer to host is triggered by the following events:

- Writing any value to register *THTRG (06h,w)*
- Setting bit *ADTT (17h.w2)* high

After host read the last byte to be transferred, this flag is deactivated.

Bit 2: APIb - Audio Playback Interrupt Flag

If *APOUT (90h,1-0)* are not zero, this bit is used as audio-playback-interrupt flag.

Bit 1: DFRDYb - Data FIFO Ready

After data transfer is triggered, the 32-byte Data FIFOs are automatically filled. This bit is used to indicate that the Data FIFOs are ready to be read by the host for debugging. The Data FIFO is automatically cleared in any of the following conditions:

- Chip reset, host reset and firmware reset
- *DTEN (01h.w1)* is 0
- *DINB (1Fh.w1)* is 1
- *DFRST (2Bh.w3)* is 1
- The end of data-in transfer

Bit 0: SC1b - Subcode Interrupt Flag

If *SCIEN (2Ch.w4)* is enabled, this bit becomes active-low when one of the following events occurs:

- *ISS (22h.r0)* becomes active-high
- *NESBK (22h.r1)* becomes active-high
- *MSS (22h.r2)* becomes active-high

When Subcode Interrupt is activated, the microprocessor can read register *SUBSTA (22h,r)* to determine the reason of interrupt. Writing register *SCIACK (22h,w)* deactivates this flag



TWCL - Transfer Word Counter Low- (read/write 02h)

Before triggering data transfer, the number of words to be transferred should be set through 12-bit Transfer Word Counter (TWC). The number of **words** minus 1 should be written to this counter while using standard ATAPI 16-bit data transfer. After host read one word, the counter is decreased by one. *Transfer End Interrupt Flag, TENDb (01h.r6)*, is activated when this counter becomes zero.

Bit 7-0: TWCH[7:0] - Transfer Word Count Low

TWCH - Transfer Word Counter High - (read/write 03h)

Bit 7: LATXF - Linear Address Transfer Enable

If this bit is high, the Linear Address Transfer is enabled. In this case, the data stored from the address specified by *RAC (2Dh, 1Dh, 1Ch)* are transferred to host after trigger. The size of transfer data is limited by *TWC (03h/02h)*. Setting this bit high cause *UTBY (1Fh.r7)* high to inhibit uP to access *RAMRD (1Eh,r)* or *RAMWR (1Eh,w)*.

If this bit is low, the Block-Offset Transfer is enabled. In this case, the data stored from the address specified by *TBH/L (25h/24h)* and *TACH/L (05h/04h)* are transferred to host after trigger. The address of data warps around at the block boundary, so the size of transfer data is limited by block size.

Bit 3-0: TWCH[3:0] - Transfer Word Count High

TACL/TACH - Transfer Address Counter - (write 04h/05h)

Before triggering block-offset data transfer, the external RAM address of data to be transferred should be set through *TACH/L (05h/04h,w)*. This number in this counter specifies the first available data address relative to the beginning of the block. The block number should also be specified through Transfer Block registers *TBH/L (25h/24h)*. After one word is read by host, *TACH/L* are incremented to the next available data address. The following equation illustrates the relation between block-offset and linear address:

$$\text{linear address} = (\text{block number} \cdot \text{block size}) + \text{address offset}$$

THTRG - Transfer to Host Trigger Register - (write 06h)

This register is used to trigger data transfer regardless of what value is written. If *DINB (1Fh.1)* is low, triggering this register automatically fills the Data FIFO and then flag *DFRDYb (01h.r1)* becomes active-low when the Data FIFO becomes ready. If *DINB (1Fh.1)* is high, data-out transfer is enabled, e.g., parameter of mode-select command. A more convenient way is set *ADTT (17h.w2)* high and then trigger hardware data transfer sequence.



TACK - Transfer Acknowledge - (write 07h)

Writing this register deactivates flag *TENDb (01h.r6)* and its corresponding interrupt regardless of what data is written.

HEAD0 to HEAD3 - Header Registers - (read 03h to 07h)

These four registers are used to hold the information of Header Bytes of each sector. Header Registers should be read soon after *STAVAb (0Fh.r7)* becomes active-low. Note that the header bytes are distrustful if wrong mode is set while ECC is enabled. If bit *SHDEN (0Bh.w0)* is enabled, registers *HEAD0-3* are used to hold subheader bytes instead.

If control bit *QMSF (80h.w4)* is set high, the corresponding MSF bytes in Q-channel information would be automatically loaded into *HEAD0-2 (04h-06h,r)* when each byte is ready from DSP. **Notice** that the value in register *HEAD3 (07h,r)* and *SUBH0-3 (14h-17h,r)* are not available in this case.

BIAL/BIAH - Buffering Initial Address - (write 08h/09h)

The rule for configuration is that the first byte of the sector is stored at

$$BIAH/L(09h/08h) - 0Ch$$

Before enabling the external RAM buffering through *CTRL0 (0Ah,w)*, *BIAH/L* should be set to control the location of the first byte follows data sync for each data sector. The RAM block for buffering is controlled by the number in registers *DDBH/L(29h/28h)* plus one. For convenience of following data transfer, the microprocessor may set proper value to *BIAH/L* after the mode is determined so that the first user data byte will locate at offset 00h of each data block.

| | CD-DA | yellow book mode 1 & mode 2 | CD-ROM XA mode 2 |
|------------------------|-------|--------------------------------|---------------------|
| BIAH/L(08h/09h) | 000Ch | FFFCh | FFF4h |
| first sync | n/a | FFF0h | FFE8h |
| first header | n/a | FFFCh | FFF4h |
| first subheader | n/a | n/a | FFF8h |
| first data | 0000h | 0000h | 0000h |

BACL, BACH - Buffering Address Counter - (read 0Ah/0Bh)

After enabling the external RAM buffering, Buffering Write Counter is automatically increased by two, beginning from the value specified by *BIAH/L (09h/08h,w)*, every time a data word is buffered.



EIAL/EIAH - ECC Initial Address - (read 08h/09h, write 0Ch/0Dh)

EIAH/L are used to hold the initial address offset of the data block to be corrected. The content of BIAH/L (09h/08h,w) will be automatically loaded to EIAH/L at the beginning of each data sync, making it unnecessary to read or write EIAH/L during normal operation. The RAM block for ECC is controlled by the number in registers DDBH/L (29h/28h).

CTRL0 - Control Register 0 - (write 0Ah)

This register is 0 after chip reset, host reset, firmware reset and decoder reset.

Bit 7: DECEN - Decoding Logic Enable

Setting this bit high enables the decoding logic.

Bit 6: RTEDC - Real Time EDC Checking Enable

Setting this bit high enables the real-time-EDC-checking logic. The RSPC error correction is performed only when the result of real time EDC check is error. This function could save about 2/3 of DRAM bandwidth compared with conventional decoder.

Bit 5: EDCEN - Error Detect and Correct Enable

Setting this bit high enables the ECC and EDC logic. Change of this bit takes effect after next sync.

Bit 4: ACEN - Automatic Correction Enable

If both *M2RQ* (0Bh.w3) and this bit is high, the type of error correction is automatically determined by FORM bit in the subheader byte. If only *M2RQ* (0Bh.w3) is high, the type of error correction is controlled by *F2RQ* (0Bh.w2). If *M2RQ* (0Bh.w3) is low, this bit does not affect the correction of mode 1 data.

Bit 3: PKTINH - obsolete

Bit 2: BUFEN - Buffering Enable

Setting this bit high enables incoming DSP data buffering. When this bit is high, the values of register HEAD0-3(04h-07h) and SUBH0-3(14h-17h) are retrieved from external RAM rather than from incoming serial data. When BUFEN is low, any setting of QCEN or PCEN is meaningless. Change of this bit takes effect after next sync.

Bit 1: QCEN - Q-codeword Correction Enable

When this bit is high, Q-codeword RSPC correction logic is enabled. Change of this bit takes effect after next sync.

Bit 0: PCEN - P-codeword Correction Enable

When this bit is high, P-codeword RSPC correction logic is enabled. Change of this bit takes effect after next sync.

| DECEN 0Ah.7 | BUFEN 0Ah.2 | EDCEN 0Ah.5 | QCEN 0Ah.1 | PCEN 0Ah.0 | Decoder Mode | Operation Flow |
|----------------|----------------|----------------|---------------|---------------|--------------------|-------------------|
| 1 | 1 | 1 | 1 | 1 | Q-P correction | Q → P → CRC |
| 1 | 1 | 1 | 1 | 0 | Q-correction | Q → CRC |
| 1 | 1 | 1 | 0 | 1 | P-correction | P → CRC |
| 1 | 1 | 1 | 0 | 0 | Buffer-only | CRC |
| 1 | 0 | 0 | 0 | 0 | Disk-monitor | no buffering |
| 0 | X | X | X | X | Decoder disable | no operation |

Note that if *ATMSEN* (9Ah.6) is high, the decoder logic will operate in Disk-monitor mode before the target is found. When the target is found, the setting of register *CTRL1* (0Bh,w) will be automatically loaded into decoder logic.

CTRL1 - Control Register 1 - (write 0Bh)

This register is 0 after chip reset, host reset, firmware reset and decoder reset.

Bit 7: SIEN - Sync Insertion Enable

When this bit is high, the sector boundary is determined by internal sync insertion logic.

Bit 6: SDEN - Sync Detection Enable

When this bit is high, the sector boundary is determined by sync bytes of incoming serial data. This bit should not set for reading CD-DA data.

Bit 5: DSCREEN - Descrambler Enable

Setting this bit is high enables the descramble logic. This bit should not set for reading CD-DA data.

Bit 4: CWEN - Corrected Data Write Enable

Setting this bit high enables corrected data to be written to the external RAM. This bit is normally set when correction is enabled by *QCEN* (0Ah.w1) or *PCEN* (0Ah.w0).

Bit 3: M2RQ - Mode 2 ECC Request

Setting this bit to high enables the CD-ROM XA mode 2 correction logic. Yellow book Mode 1 correction will be performed if this bit is low.

Bit 2: F2RQ - Form 2 Request

Setting this bit high request the data to be processed by the CD-ROM XA mode-2 form-2 format if *M2RQ* (0Bh.3) is high. If *M2RQ* (0Bh.3) is high and this bit is low, the CD-ROM X1 mode-2 form-1 correction will be performed. This bit is not effective if *ACEN* (0Ah.w4) is high.



Bit 1: MCRQ - Mode Byte Check Request

When this bit is high, ECC logic will check the 4th header byte with the setting of *M2RQ* (0Bh.3) to determine if ECC correction to be performed.

Bit 0: SHDEN - Subheader Switch Enable

When this bit is high, registers *HEAD* (04h-07h,r) are used to provide subheader bytes.

| disc format | SIEN (0Bh.7) | SDEN (0Bh.6) | DESCRE N (0Bh.5) | CWEN (0Bh.4) | M2RQ (0Bh.3) | F2RQ (0Bh.2) |
|--------------------|-----------------|-----------------|---------------------|-----------------|-----------------|-----------------|
| CD-DA | 1 | 0 | 0 | 0 | 0 | 0 |
| yellow book Mode 1 | 1 | 1 | 1 | 1 | 0 | 0 |
| yellow book Mode 2 | 1 | 1 | 1 | 0 | 0 | 0 |
| CD-ROM XA M2F1 | 1 | 1 | 1 | 1 | 1 | 0 |
| CD-ROM XA M2F2 | 1 | 1 | 1 | x | 1 | 1 |

STAT0 - Status Register 0 - (read 0Ch)

Bit 7: CRCOK - Cyclic Redundancy Check OK

This bit is used to indicate that the Cyclic Redundancy Check of the latest available sector is passed.

Bit 6: ILSYN - Illegal Sync Pattern

If *SDEN* (0Bh.w6) is high, this bit becomes high when a sync pattern is detected less than 2352 bytes after last sync pattern was detected/inserted.

Bit 5: NOSYN - No Sync Pattern

If *SIEN* (0Bh.w7) is high, this bit becomes high when a sync pattern is not detected at 2352 bytes after last sync pattern was detected/inserted.

Bit 4: LBKF - Long Block Flag

If *SIEN* (0Bh.w7) is low, this bit becomes high when a sync pattern is not detected at 2352 bytes after last sync pattern was detected/inserted.

Bit 3: WSHORT - Word Short

This bit becomes high when the incoming serial data rate is too high to be processed.

Bit 2: SBKF - Short Block Flag

If *SDEN* (0Bh.w6) is low, this bit becomes high when a sync pattern is detected less than 2352 bytes after last sync pattern was detected/inserted.



| Status Flag | SIEN (0Bh.7) | SDEN (0Bh.6) | Internal Operation |
|--------------|-----------------|-----------------|---|
| ILSYN(0Ch.6) | x | 1 | re-synchronize internal sync logic |
| NOSYN(0Ch.5) | 1 | x | internal sync logic provide internal sector boundary |
| LBKF(0Ch.4) | 0 | x | internal sync logic do not provide internal sector boundary |
| SBKF(0Ch.2) | x | 0 | do not re-synchronize internal sync logic |

Bit 1: reserved

Bit 0: UEBK - Uncorrectable Errors in Block

This bit is used to indicate that at least one data is corrected in the latest available data block.

STAT1 - Status Register 1 - (read 0Dh)

Bit 7-5: BI[2:0] - Raw Block Indicator

| BI[2:0] | Block Type |
|---------|----------------------|
| 000 | Data Block |
| 001 | Fourth Run-in Block |
| 010 | Third Run-in Block |
| 011 | Second Run-in Block |
| 100 | First Run-in Block |
| 101 | Link Block |
| 110 | Second Run-out Block |
| 111 | First Run-out Block |

Bit 4: HDERA - Header Erasure

This bit is high if there is at least one erasure flag detected in header bytes excluding mode byte. Erasure in mode byte will cause *RMOD* (0Eh.r7-4) all become high.

Bit 0: SHDERA - Subheader Erasure

This bit is high if erasure flags are detected for both bytes in at least one subheader byte-pairs.

Erasures are latched from pin C2PO if *BUFEN* (0Ah.w2) is disabled. Otherwise, header and subheader bytes are retrieved from external RAM while the following sector is being buffered.



DHTACK - DRAM to Host Transfer Acknowledge - (write 0Eh)

Writing DHTACK, regardless of what data is written, deactivates *TENDb* (01h.r6) that caused by data-in transfer.

STAT2 - Status Register 2 - (read 0Eh)

Bit 7-4: RMOD[3:0] - Raw Mode Bit

RMOD2-0 are directly latched from bit 2-0 from the 4th header byte and RMOD3 is high if any one of the other 5 bits in the mode byte is high. RMOD3 is also high if a mode byte erasure is detected.

Bit 3: MODE2 - Mode 2 Selected Flag

This bit reflects the setting of *M2RQ* (0Bh.w3).

Bit 2: NOCOR - No Correction

If ECC logic is enabled by bit *EDCEN* (0Ah.w5), and *QCEN* (0Ah.w1) or *PCEN* (0Ah.w0), this bit becomes high if ECC logic is interrupted the followings:

- *CWEN* (0Bh.w4) is disabled.
- Mode mismatch is detected while *MCRQ* (0Bh.w1) is enabled.
- Mode erasure is detected while *MCRQ* (0Bh.w1) is enabled. A mode erasure occurs if the incoming C2PO flag is set for the fourth header byte, indicating unreliable mode data.
- Form 2 enabled while ECC logic is set to mode 2. Form 2 blocks should not be corrected. Form 2 can be enabled by control bit *F2RQ* (0Bh.w2), or by the Form bit in the Subheader byte if *ACEN* (0Ah.w4) is enabled.
- Form bit erasure while ECC logic is set to mode 2 and *ACEN* is enabled. A form bit erasure is detected if the incoming C2PO flags are set for both Form bits in the Subheader bytes.
- *ILSYN* (0Ch.r6) becomes high while *SDEN* (0Bh.w6) is enabled

Bit 1: RFERA - Raw Form Erasure

This bit becomes high when a form bit erasure was detected. A form bit erasure is detected if the incoming C2PO flags are set for both Form bits in the Submode bytes (bit 5 in byte 18 and 22). RFERA becomes valid when *SR1b* (01h.r5) becomes active-low, and remains valid until the next block sync.

Bit 0: RFORM - Raw Form Bit

This bit is high if the Form bit is high in the Submode bytes of the incoming serial data. RFORM becomes valid when flag *SR1b* (01h.r5) becomes active-low, and remains valid until the next block sync.



FRST - Firmware Reset Register - (write 0Fh)

Writing this register, regardless of what value is written, trigger a firmware reset. Flag *FRST (2Fh.r1)* is set by firmware reset.

STAT3 - Status Register 3 - (read 0Fh)

Bit 7: STAVAb - Valid Status Valid

This bit is used to indicate that the header, pointer, and status registers about decoder logic are available. This bit should not be used if *BICEN (9Ah.7)* is high.

Bit 5: ECF - Error Corrected Flag

This bit is used to indicate that there is at least one byte was corrected in the latest available block.

Bit 1: C2DF - C2 Detected in Block Flag

If *C2WEN (10h.w2)* is high, C2DF becomes high when there is at least one C2PO flag was detected in the previous block.

Bit 6,4,3,2,0: Reserved

CTRLW - Control-Write Register - (write 10h)

This register is 0 after chip reset, host reset, firmware reset and decoder reset.

Bit 7: reserved

Bit 6: SWEN - Synchronized Write Enable

If this bit is high, the change of *BUFEN (0Ah.w2)* will be synchronized to the end of next sector sync. The buffering of C2PO flags is also controlled by this bit if *C2WEN (10h.w2)* and *BUFEN (0Ah.w2)* are both enabled. This function prevents buffering of an incomplete block.

Bit 5: SDSS - Subcode and DSP Sync Synchronization

This bit provides synchronization of CD-DA format data. If this bit is high, the writing of incoming serial data to the external RAM will start at the first left-channel lower-byte following the end of subcode block. Note that this bit should not be used when subcode logic is not enabled.

Bit 4: DCKEN - DSP Clock Enable

If this bit is high, clock from DSP is used by internal decoder logic. DCKEN should be set high before *DECEN (0Ah.w7)* is set high.

Bit 3,0: reserved

Bit 2: C2WEN - C2 Flag Write Enable

If this bit and *BUFEN (0Ah.w2)* are both high, the C2 flags of incoming serial data will be latched into the external RAM. This operation is synchronized to the end of sync if *SWEN (10h.w6)* is high.

**Bit 1: DRST - Decoder Reset**

Setting this bit to high resets decoding logic, including:

- *SRIEN* (01h.w5) ← 0
- *CTRL0* (0Ah.w) ← 00h
- *CTRL1* (0Bh.w) ← 00h
- *CTRLW* (10h.w) ← 00h
- *STAT0-2* (0Ch-0Eh,r) ← 00h
- *STAT3* (0Fh,r) ← 80h
- *TARSTA* (80h,r) ← 00h

DRST is automatically cleared by itself.

CRTRG - Correction Retry Trigger - (write 11h)

Writing register CRTRG, regardless of what data is written, triggers the decoding logic to perform another correction sequence to the same block.

Bit 7-1: Reserved**Bit 0: CRRL - Correction Retry Register Load**

Setting this bit high while writing register *CRTRG* (11h,w) re-loads the setting of *EDCEN* (0Ah.w5), *QCEN* (0Ah.w1), or *PCEN* (0Ah.w0) to decoding logic.

| Decoder Parameter | Updated at the end of sync | Updated by writing CRRL |
|-------------------|----------------------------|-------------------------|
| EDCEN (0Ah.w5) | yes | yes |
| QCEN (0Ah.w1) | yes | yes |
| PCEN (0Ah.w0) | yes | yes |
| ACEN (0Ah.w4) | yes | no |
| BUFEN (0Ah.w2) | yes | no |
| M2RQ (0Bh.w3) | yes | no |
| F2RQ (0Bh.w2) | yes | no |
| MCRQ (0Bh.w1) | yes | no |



MBTC0 - Multi-Block Transfer Control 0 - (read/write 12h)

The host interface supports multi-block transfer without microprocessor intervention by following sequence:

- *MBC* (12h.4-0) ← the number of block to be transferred minus 1 (ex. 3)
- *TWCH/L* (03h/-2h) ← the number of words to be transferred in each block minus 1 (ex. 1175)
- *TACH/L* (05h/04h) ← the starting point of the block (ex. F4h, FFh)
- *TBH/L* (25h/24h) ← the RAM block number of the first block to be transferred (ex. 5)
- *ATBHI/LO* (35h/34h) ← the total bytes to be transferred (ex. 9408)
- *ADTT* (17h.w4) ← 1

PS: *STWCEN* (18h.3) should not be set in multi-block transfer operation.

When *ADTT* is set, host will receive *HIRQ*, check status, and then start to read data.

After the last word of one block (except the last one) is read by the host, the following hardware sequence is executed:

- *TWCH/L* (03h/02h) ← reload
- *TACH/L* (05h/04h) ← reload
- *TBH/L* (25h/24h) ← auto-increment
- *MBC0* (12h.4-0) ← auto-decrement

Flag *TENDb* (01h.r6) only becomes active at the end of data transfer of the last block. This register is 0 after chip reset, host reset and firmware reset.

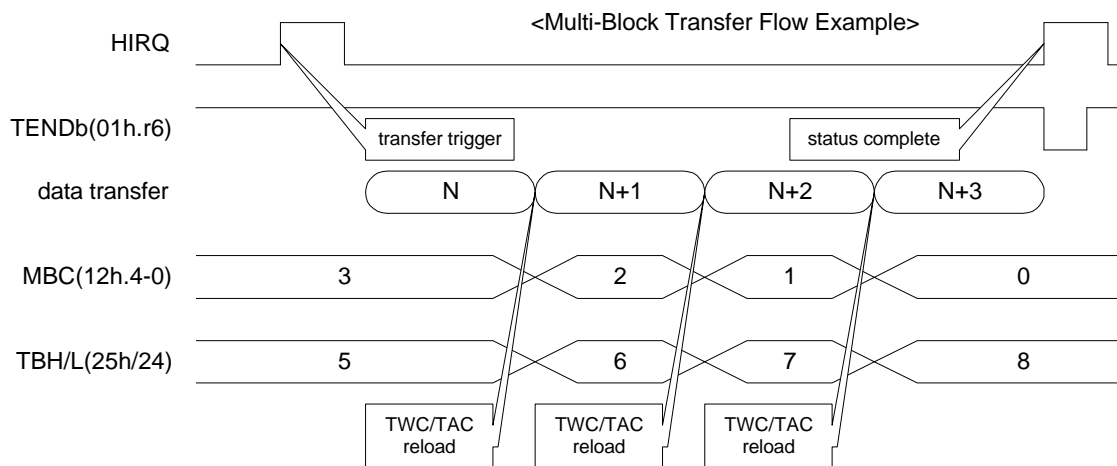

**Bit 7: MBVAb - Multi-Block Counter Valid Flag**

This bit is used to indicate that *MBC (12h.4-0)* is stable enough to be monitored by microprocessor. There is no need to monitor this bit in normal operation.

Bit 6: MBINC - Multi-Block Increment Flag

This bit becomes active-high if microprocessor sets *INCMBC (13h.w0)* and multi-block number increment has not completed. There is no need to monitor this bit in normal operation.

Bit 4-0: MBC[4:0] - Multi-Block Counter

Before triggering multi-block transfer, the number of blocks to be transferred minus 1 should be written to *MBC (12h.4-0)*. Single block transfer is performed if *MBC (12h.4-0)* is zero. There is no need to monitor this counter normal operation.

MBTC1 - Multi-Block Transfer Control 1 - (read/write 13h)

This register is for debug only. This register is 0 after chip reset, host reset and firmware reset.

Bit 7-3: Reserved**Bit 2: MBTIEN - Multi-Block Transfer Interrupt Enable**

If *MBTIEN* and *MBTFEN* are both enabled, *pin UINTb (36)* will activate at the end of data transfer of each block if the block count in *MBC (12h.4-0)* is not zero. There is no need to set this bit in normal operation.

Bit 1: MBTFEN - Multi-Block Transfer Interrupt Flag Enable

If this bit is high, *MBTI (30h.r4)* will be activated at the end of data transfer of each block if the block count in *MBC (12h.4-0)* is not zero. There is no need to set this bit in normal operation.

Bit 0: INCMBC - Increment Multi-Block Counter

Setting this bit high increments *MBC (12h.4-0)*. This function is useful in data transfer to host by DMA mode. Because data byte count is not specified in DMA mode transfer, the number of block to be transferred can be incremented when a new block becomes available before the transfer is completed.

ECTRL - Enhanced Control Register - (write 14h)**Bit 7-2: Reserved****Bit 1: IR7F - Provide Flag UTBY at IR7**

When this bit is high, flag *UTBY (1Fh.r7)* can be monitored by read bit-7 of the Index Register.



Bit 0: DISAI - Disable Auto-Increment of Microprocessor-RAM Address Counter

When this bit is high, the automatic increment of the *RAC* (2Dh/1Dh/1Ch) address counter is disabled. Note that DISAI should be 0 before *RFTRG* (2Ah.w6) is triggered.

SUBH0 to SUBH3 - Subheader Registers - (read 14h to 17h)

These registers are used to hold the information of subheader bytes. If *BUFEN* (0Ah.w2) is disabled, subheader bytes are latched from incoming serial data. If *BUFEN* (0Ah.w2) is enabled, subheader bytes are retrieved from the external RAM.

ASTRG - Automatic Sequence Trigger Register (write 17h)

The following bits will clear themselves after the triggered operation are completed.

Bit 7: Reserved

Bit 6: CSRT - Clear Soft Reset Trigger

Setting this bit high clears bit SRST in the ATAPI Device Control Register.

Bit 5: DSCT - Disk Seek Complete Trigger

If *ABYEN* (18h.1) is high, setting *DSCT* high triggers the following operations:

- Set BSY
- DSC (37h.4) ← 1
- Clear BSY

If *ABYEN* (18h.1) is low, setting *DSCT* high sets DSC(37h.4) to 1.

Bit 4: SIGT - ATAPI Signature Trigger

Setting this bit high initialize the Task Registers with ATAPI signature.

- ATFEA (31h) ← 00h
- ATERR (31h) ← 01h
- ATINT (32h) ← 01h
- ATSPA (33h) ← 01h
- ATBLO (34h) ← 14h
- ATBHI (35h) ← EBh
- ATSTA (37h) ← x00x0000b

Note that register ATDRS (36h) is not cleared by triggering SIGT to abide by the ATAPI protocol.

Bit 3: CPFT - Clear Packet FIFO Trigger

Setting this bit high clears the Packet FIFO.

Bit 2: ADTT - Automatic Data Transfer Trigger

If *PIO* (1Fh.2) is high, setting ADTT high triggers the following PIO Data Transfer sequence:

- Set BSY
- $DTEN$ (01h.w2) $\leftarrow 1$
- $SCoD$ (20h.2) $\leftarrow 0$ if $DINB$ (1Fh.1) is 0; otherwise, 1
- $ATINT$ (32h) $\leftarrow 02h$ if $DINB$ (1Fh.1) is 0; otherwise, 00h
- If $STWCEN$ (18h.w3) is enabled, then $ATBHI/LO \leftarrow (TWCH/L + 1) \cdot 2$

The data transfer logic will start to fill the Data FIFO automatically. The following sequence will be executed when $DFRDYb$ (01h.r1) become active-low:

- DRQ (37h.3) $\leftarrow 1$
- Clear BSY
- $HIRQ$ (2Eh.3) $\leftarrow 1$

After detecting the interrupt, the host will check the status and then read the data.

$STWCEN$ (18h.3) should not be used for Automatic Multiple Block Transfer. Instead, $ATBLO$, $ATBHI$ should be set by firmware to: $(MBC + 1) \cdot ((TWC + 1) \cdot 2)$

If *PIO* (1Fh.2) is low, setting ADRTG high triggers the following DMA Data Read sequence:

- Set BSY
- $DTEN$ (01h.w1) $\leftarrow 1$
- $SCoD$ (20h.2) $\leftarrow 0$ if $DINB$ (1Fh.1) is 0; otherwise, 1
- $ATINT$ (32h) $\leftarrow 02h$ if $DINB$ (1Fh.1) is 0; otherwise, 00h

Bit 1: DRQT - DRQ Trigger

If bit *PIO* (1Fh.2) is high, setting this bit high triggers the following hardware sequence:

- DRQ (37h.3) $\leftarrow 1$
- $BSY \leftarrow 0$
- $HIRQ$ (2Eh.3) $\leftarrow 1$

When bit *PIO* is low (DMA mode), this bit should not be triggered.

Bit 0: SCT - Status Completion Trigger

Setting this bit high triggers the following hardware sequence:

- $CHECK$ (37h.0) $\leftarrow ACHECK$ (3Eh.0)
- $CORR$ (37h.2) $\leftarrow ACORR$ (3Eh.2)
- $DRDY$ (37h.6) $\leftarrow ADRDY$ (3EH.6)
- $ATINT$ (32h) $\leftarrow 03h$



- Clear BSY
- *HIRQ* (2Eh.3) ← 1
- *APKTEN* (18h.7) ← 1, if *AUTOEN* (18h.4) is high
- *ASCEN* (18h.5) ← 0

After detecting the interrupt, the host reads the ATAPI Status Register and if necessary, the Error Register for the command completion status.

ASCTRL - Automatic Sequence Control register - (read/write 18h)

Bit 7: **APKTEN - Automatic Packet Transfer Enable**

Setting this bit high enables Automatic Packet Transfer logic. When APKTEN is high, the following hardware sequence is performed if host issues opcode A0h to the ATA Command Register if drive has been selected:

- Set BSY (37h.7)
- *APKT* (30h.r0) ← 1
- Clear Packet FIFO
- *ATERR* (31h) ← 00h
- *ATINT* (32h) ← 01h
- *DTEN* (01h.w1) ← 1
- *TENDEN* (01h.w6) ← 1, if *HIIEN* (2Eh.7) is high
- *SCoD* (20h.2) ← 1
- *CHECK* (37h.0) ← 0
- *CORR* (37h.2) ← 0
- *DRQ* (37h.3) ← 1
- *DSC* (37h.4) ← 1, if *ASDSC* (3Dh.4) is high
- *DRDY* (37h.6) ← 1
- *HIRQ* (2Eh,3) ← 1, if *A0IEN* (18h.0) is high
- *APKTEN* ← 0
- Clear BSY (37h.7)

ATAC (2Fh.w6) will not be activated during Automatic Packet Transfers.

When the drive becomes ready after BSY is cleared, the host starts to issue 12-byte ATAPI Command Packet. Reception of the 6th packet word activates the following events.

- *FPKT* (30h.r1) ← 1
- *TENDb* (01h.r6) ← 0
- Pin UINTb activate if *TENDEN* (01h.w6) has been enabled



Writing any value to register TACK (07h) deactivates APKT, TENDb, and corresponding interrupt.

Bit 6: ADCEN - Automatic DRQ Clearing Enable

When this bit is high, DRQ (37h.3) is cleared to 0 and BSY (37h.7) is set to 1 after the end of following transfers:

- Host reads from external RAM
- Host writes to Command Packet FIFO

Bit 5: ASCEN - Automatic Status Completion Enable

When this bit is high, Status Completion is performed after the end of the following transfers:

- Host reads from external RAM
- Host writes to Command Packet FIFO

ADCEN (18h.6) should be enabled when *ASCEN* is enabled to provide clearing of DRQ (37h.3) and setting of BSY (37h.7). If both *ADCEN* and *ASCEN* are enabled, the following hardware sequence is executed at the end of one of the above data transfers:

- Set BSY
- DRQ (37h.3) ← 0
- CHECK (37h.0) ← ACHECK (3Eh.0)
- CORR (37h.2) ← ACORR (3Eh.2)
- DRDY (37h.6) ← ADRDY (3Eh.6)
- ATINT (32h) ← 03h
- Clear BSY
- HIRQ (2Eh.3) ← 1
- APKTEN (18h.7) ← 1, if AUTOEN (18h.4) is high
- ASCEN (18h.5) ← 0

After detecting the interrupt, the host reads the ATAPI Status Register and if necessary, the Error Register for the command completion status.

Bit 4: AUTOEN - Automatic APKTEN Set After Status Completion Enable

When this bit is high, APKTEN (18h.7) will be set after Automatic Status Completion sequence triggered by either SCT (17h.0) or ASCEN (18h.5).

Bit 3: STWCEN - Set Transfer Word Count Enable

When this bit is high, the value $(TWCH/L + 1) \cdot 2$ is loaded into ATBLO and ATBHI when ADTT (17h.2) is triggered and PIO (1Fh.2) has been set high. If *ACMEN* (9Ch.6) is not enabled, control bit *STWCEN* should not be set for Multiple Block Transfer. Instead, ATBHI/LO should be set by firmware to: $(MBC4-0 + 1) \cdot (TWCH/L + 1) \times 2$.

**Bit 2: AUCRCEN - Automatic Ultra DMA CRC Error Logic Enable**

If *AUCRCEN* (18h.2) is set high, the automatic status complete logic would be stopped if *UCRCOKB* (30h.r3) is high. If no CRC error has occurred in last Ultra DMA burst, status complete sequence would be automatically executed. This bit should be set high only if *ASCEN* (18h.5) is set high as well. This bit is automatically clear when: (1) automatic status complete sequence is triggered or (2) *SCT* (17h.w0) is set high.

Bit 1: ABYEN - Automatic BSY Set Enable

When this bit is high, the following sequence is executed when Disk Seek Complete is triggered by *DSCT* (17h.w5):

- Set BSY
- DSC (37h.4) ← 1
- Clear BSY
- DSCT ← 0

Bit 0: A0IEN - A0h Command Interrupt Enable

If this bit is high and *APKTEN* (18h.7) has been enabled, *HIRQ* (2Eh.3) becomes active-high after an opcode A0h is issued to ATA Command Register.

CCTL0 - Clock Control Register 0 - (write 19h)

This register is 0 after chip reset.

Bit 7: CKSTP - Clock Stop

Setting this bit high stops the internal clock and the clock output at pin CLK0. CKSTP is deactivated by the following events:

- Chip reset or host reset or firmware reset
- Command write from the host while the drive is selected
- Host issues Diagnostic Command, regardless of drive selection
- Host issues command to shadow drive if SHDRV (3Fh.6) is enabled
- Host set bit SRST in ATAPI Device Control Register high, regardless of drive selection

Bit 6: reserved**Bit 5: JPSS - Jumper Sampling Select**

This bit is used to control the sampling of pin RD15/DJ. When JPSS is high, pin RD15/DJ is sampled while chip reset is active. When this bit is low, PAR/JP is sampled while chip reset or host reset are active.

Bit 4: Reserved**Bit 3-0: CKS[3:0] - Clock Skew Control**

CKS3-0 are used to control the duty cycle of the internal clock. The low period of cycle increases as the skew value increments.

CCTL1 - Clock Control Register 1 - (write 1Ah)

This register is 0 after chip reset.

Bit 7: CLKOEN

Setting this bit high enable *pin CLKO (13)* as clock output if *APOUT (90h.1-0)* is zero.

| CLKOEN (1Ah.7) | APOUT1-0 (90h.1-0) | Function of pin 13 | Remark |
|----------------|--------------------|---------------------------------|---------|
| 0 | 0 | tri-state with internal pull-up | default |
| 1 | 0 | clock output | |
| x | not 0 | audio LRCK output | |

Bit 6: TSYNC - Test Synchronization Control

When this bit is high, the detected/inserted sync can be monitored from *pin CLKO (13)*.

Bit 5: XININV - Inverted XIN as System Clock

When this bit is high, the internal system clock is inverted from crystal input pin *XIN (15)*.

Bit 4: PSKEN - Programmable System Clock Enable

When this bit is high, the frequency of internal system clock is controlled by register *PSKCTL (59h)*.

Bit 3,2: CLK[1:0] - Pin CLKO Select

| CLK1-0 | Frequency of CLKO | Remark |
|--------|-------------------|---------|
| 0 | $SF \div 2$ | default |
| 1 | $SF \div 4$ | |
| 2 | $SF \div 1$ | |
| 3 | reserved | |

SF is the system frequency. Notice that the relation between system frequency and crystal frequency depends on the setting of *XTALD2 (1Ah.w0)* and *PSKEN (1Ah.w4)*.

Bit 1: Reserved

Bit 0: XTALD2 - Crystal Divided by 2

The internal clock frequency is half of crystal frequency if this bit is high.

VER - Version Register - (read 1Ah)

This register is used to hold the version number.



DSPSL - DSP Selection Register - (write 1Bh)

Bit 7: C2ML - C2 MSB to LSB

When this bit is high, the sequence of erasures via *pin C2PO* (11) is from MSB to LSB.

Bit 6: S16O - Select 16 Offset

The incoming serial data is latched one clock after *pin LRCK* (13) changes if this bit is high.

Bit 5: LCHP - Left Channel Polarity

The incoming serial data is latched as left channel when *pin LRCK* (13) is high if this bit is high.

Bit 4: SFT8 - Shift 8 Clocks

The incoming serial data is latched by delay 8 clocks if this bit is high.

Bit 3: Reserved

Bit 2: SEL16 - Select 16 Bits Per Channel

The incoming serial data is latched 16 times per channel if this bit is high.

Bit 1: DIR - Data Direction

Setting this bit high selects the direction of data from *pin SDATA* (9) from MSB to LSB.

Bit 0: EDGE - Latching Edge Select

Setting this bit high selects the rising edge of BCK for latching data from *pin SDATA* (9).

DSP setting example:

| DSPSL | DSP Data Format |
|-------|------------------|
| 07h | Toshiba |
| 24h | Sanyo |
| A3h | Sony 48-bit slot |
| C3h | Philip |

C2BEB - C2 Block Error Byte - (read 1Bh)

The Block Error Byte is the OR of all the C2 Error Flag bytes.

RACL, RACH, and RACU - RAM Address Counter - (write 1Ch, 1Dh, 2Dh)

These three registers are used to set linear address of the external RAM. Before accessing registers RAMRD/RAMWR or triggering linear-address transfer, microprocessor should set these registers. The microprocessor should write the RAM starting address into the counter while busy flag *UTBY* (1Fh.r7) is low. Then this counter increases automatically each time when a byte is read or written.



RAMWR - RAM Write Register - (write 1Eh)

To gain access to external RAM, the microprocessor should first wait for flag *UTBY* (1Fh.r7) to become low, then set the address through *RACLU/H/L* (2Df/1Dh/1Ch).

Writing data into register RAMWR triggers the following sequence:

- Data is transferred from the microprocessor to register RAMWR.
- Data is transferred from RAMWR to the RAM located by the address counter.
- Increments RACL, RACH, and RACU increments by one
- Clear flag UTBY

RAMRD - RAM Read Register - (read 1Eh)

To gain access to external RAM, the microprocessor should first wait for flag *UTBY* (1Fh.r7) to become low, then set the address through *RACLU/H/L* (2Df/1Dh/1Ch).

Writing data into register RAMRD triggers the following sequence:

- Data previously stored in RAMRD is transferred to the microprocessor.
- RAM data located by the address counter is transferred to the RAMRD register.
- Increments RACL, RACH, and RACU increments by one
- Clear flag UTBY

Note that the first data read from RAMRD is invalid.

HICTL0 - Host Interface Control Register - (write 1Fh)

Bit 7-6: reserved

Bit 5: H16S - (obsolete)

No matter what value is set, the data transfer between host and decoder is using 16-bit protocol.

Bit 4: LAEN - Latch Enable

If this bit is high, host address and chip-select signals will be latched when pins HRDb or HWRb change from high to low.

Bit 3: MDMA - Multi-word DMA mode

Setting this bit to high enables multi-word DMA mode if *PIO* (1Fh.2) is low.

Bit 2: PIO - PIO/DMA mode select

Setting this bit high causes data transfer to/from host using PIO mode. This bit is also controlled by bit-0 of *ATFEA* (1F1h/171h) if *ASMDA* (5Bh.7) is high.

Bit 1: DINB - Data-In Transfer Enable

Setting this bit low select data-in transfer. Otherwise, the data-out transfer is enabled.

**Bit 0: UDMA - Ultra DMA Enable**

Setting this bit high selects data transfer protocol as Ultra DMA. The bandwidth of Ultra DMA depends on the system frequency and the setting of *UDT1-0 (8Ah.5-4)*.

| | HICTL0 (1Fh,w) | |
|-----------|----------------|----------|
| | data-in | data-out |
| PIO mode | xCh | xEh |
| MDMA mode | x8h | xAh |
| UDMA mode | x9h | xBh |

STAT5 - Status Register 5 - (read 1Fh)**Bit 7: UTBY - Microprocessor to RAM Transfer Busy**

When the microprocessor-to-RAM transfer is not complete, this bit is high.

Bit 6-4: Reserved**Bit 3: MDMA - Multi-word DMA mode****Bit 2: PIO - PIO/DMA mode select****Bit 1: DINB - Data-In Transfer Enable****Bit 0: UDMA - Ultra DMA Enable****HICTL1 - Host Interface Control Register - (write/read 20h)**

The value in this register is 26h after chip reset.

Bit 7 : reserved**Bit 6: PDIAGEN - Pin PDIAGb Enable**

Setting this bit high causes pin PDIAGb to the active-low state. PDIAGEN is automatically de-activated, causing pin PDIAGb to be high-impedance, by the following events:

- Reception of Execute Drive Diagnostics Command (ATA opcode 90h)
- Reception of ATA Soft Reset (SRST)
- Chip reset or Host reset

Bit 5: DASPEN - Pin DASPb Enable

Setting this bit high activates pin DASPb. DASPEN is automatically de-activated, causing pin DASPb to be high-impedance, by the following events:

- Reception of Execute Drive Diagnostics Command (ATA opcode 90h)
- Reception of ATA Soft Reset (SRST)



- Chip reset or Host reset

This bit is also controlled by DASPS2 (3Fh.2), DASPS1 (3Fh.1) and DASPSS (3Fh.0).

Bit 4: CLRBSY - Clear BSY

Setting this bit high causes the flag BSY in the ATAPI Status Register to become low if *APKT* (30h.r0) is not high. This bit is self-clear after the BSY is clear.

Bit 3: SETBSY - Set BSY

Setting this bit high causes the flag BSY in the ATAPI Status Register to become high if *APKT* (30h.r0) is not high. This bit is self-clear after the BSY is set.

Bit 2: SCoD - Select Command-Packet-FIFO or Data

The data received from ATAPI Data port is stored in Packet FIFO if this bit is high. This bit is also controlled by *ADTT* (17h.w2) and *APKTEN* (18h.7).

Bit 1: RDYEN - Pin IORDY Enable

Setting this bit high enables IORDY (pin 49) to work with HRDb (pin 50).

Bit 0: IO16EN - Pin IOCS16b Enable

Setting this bit high allows pin IOCS16b to become active-low when 16-bit data access is in use. This bit should be enabled in normal operation.

SICTL0 - Subcode Interface Control Register 0- (write 21h)

Bit 7-4: Reserved

Bit 3: PQENB - P-data or Q-data Enable

Bits 7 and 6 of subcode data are written to the external RAM if this bit is low.

Bit 2-0: SUBCS[2:0] - Subcode Clock Select

These bits are used to select subcode clock rate.

| SUBCS[2:0] | Disk Speed | Subcode Block Rate |
|------------|------------|--------------------|
| 0 | 1 fold | 75 sectors/sec |
| 1 | 2 fold | 150 sectors/sec |
| 2 | 4 fold | 300 sectors/sec |
| 3 | - | reserved |
| 4 | 6 fold | 450 sectors/sec |
| 5 | 8 fold | 600 sectors/sec |
| 6 | - | reserved |
| 7 | - | reserved |



SCIACK - Subcode Interrupt Acknowledge - (write 22h)

Writing any value to this register de-activates *SCl**b*** (01h.r0) if *SCIEN* (2Ch.w4) is enabled.

SUBSTA - Subcode Status Register - (read 22h)

When *SCl**b*** (01h.r0) is activated, the microprocessor can read this register to determine the reason of interrupt.

Bits 7-5: Reserved

Bit 4: QCRCOK - Q-channel CRC OK flag

If Q-channel extraction is enabled, this bit reflects the status of CRC checking of Q-channel information.

Bit 3: reserved

Bit 2: MSS - Missing Subcode Sync

A missing-subcode-sync sets MSS high and negates *SCl**b*** (01h.r0). A microprocessor interrupt is activated also if *SCIEN* (2Ch.w4) is enabled.

Bit 1: NESBK - Normal End of Subcode Block

A normal-subcode-block-end sets NESBK high and negates *SCl**b*** (01h.r0). A microprocessor interrupt is activated also if *SCIEN* (2Ch.w4) is enabled.

Bit 0: ISS - Illegal Subcode Sync

An illegal-subcode-sync sets ISS high and negates *SCl**b*** (01h.r0). A microprocessor interrupt is activated also if *SCIEN* (2Ch.w4) is enabled.

TBH/L - Transfer Block Register - (read/write 25h/24h)

If *LATXF* (03h.7) is low, *TBH/L* form a 9-bit counter that is used to specify the first RAM block to be transferred, while registers *TACH/L* (05h/04h,w) specify the starting address relative to the beginning of this RAM block. The block-offset transfer is carried within a **transfer ring** that is controlled by *DTRCH/L* (53h/52h) and *DTRBH/L* (51h/50h). The buffer ring and transfer ring are usually defined in the same range.

Note that *TBH/L* (25h/24h) do not increment automatically at the end of each transfer unless:

- *ACMEN* (9Ch.6) is high
- *DINB* (1Fh.1) is low (data-in transfer is enabled)
- *LATXF* (03h.7) is low (block-offset transfer is used)

If *ACMEN* (9Ch.6) is high, *TCC* (9Dh) minus **N** and *TBH/L* (25h/24h) plus **N** right after *SKIPC* (9Eh) is set **N**.

If *BICEN* (9Ah.7) is high and *BCFSEL* (9Ah.5) is low, the DSP buffering stop when buffering block (internal) reach *TBK* (9Bh,w).



SCBH/L - Subcode Block Register - (read/write 27h/26h)

SCBH/L (27h/26h) form a 9-bit counter that contains the block number of the latest available subcode data that can be read by the host. The number in SCBH/L (27h/26h) plus 1 points to the RAM block that is buffering incoming subcode. The number in SCBH/L (27h/26h) increments at the end of subcode block buffering. If SDBS (88h.4) is high, the buffering of subcode is controlled by DDBH/L (29h/28h) rather than SCBH/L (27h/26h).

DDBH/L - Decoded Data Block Register - (read/write 29h/28h)

DDBH/L(29h/28h) form a 9-bit counter that contains the number of the latest available decoded data block after decoder interrupt occurs. CD-ROM sector data buffering is a block-based ring operation.

In *Real-Time-Correction (RTC)* mode, i.e., BICEN (9Ah.7) is low, if the number in DDBH/L (29h/28h) is $N - 1$, then the current sector is buffered into block with number N . The DDBH/L (29h/28h) increments at each sync. When the decoded-block-number equals the value in WBRCH/L (57h/56h), the sector is buffered into the block with number specified by WBRBH/L (55h/54h).

In *Buffer-Independent-Correction (BIC)* mode, i.e., BICEN (9Ah.7) is low, DDBH/L (29h/28h) increments at the end of EDC-checking if there is no STAERR (80h.r6) or HCEI (80h.r0) error.

RAMCF - RAM Configuration Register - (read/write 2Ah)

This register is 0 after chip reset.

Bit 7: RFTYP - Refresh Type

The refresh mode of DRAM is CAS-before-RAS if this bit is high. The refresh mode of DRAM is RAS-only if this bit is low.

Bit 6: RFTRG - RAM Filling Trigger

Setting this bit high triggers the DRAM filling. All locations in the external RAM will be filled with the value in register RAMWR (1Eh,w). The value (ex:00h) should be written to registers RACL, RACU, and RACH before triggering RFTRG. Flag RFC (2Ah.r5) will change from 0 to 1 when all RAM locations have been filled. After RAM Filling has completed, the microprocessor should clear RFTRG to 0.

Bit 5: RFC - RAM Fill Completion Flag (read only)

This flag will change from 0 to 1 when all RAM locations have been filled with the value in register RAMWR (1Eh,w). This flag is clear when RFTRG is disabled.



Bit 5: Reserved (write only)

Bit 4: SWAP - Host High-Low Swap

Setting this bit high causes the host access of high/low byte to be swapped.

Bit 3: Reserved

Bit 2-0: RTC[2:0] - External RAM Type Configuration Bits

The external RAM should be appropriately configured by these three bits according to its specification. RTC[2:0] are de-activated by chip reset or host reset, but are not changed by firmware reset.

| RTC[2:0] | RAM Configuration |
|-----------|--|
| 0,1, 4, 7 | reserved |
| 2 | 256K x 4-bit x 2, 256K x 8-bit x 1, 128K x 8-bit x 1, 8-Row 9-Column |
| 3 | 128K x 8-bit x 1, 9-Row 8-Column |
| 4 | 64K x 16-bit x 1, (8-row 8-Column) 128K x 16-bit x 1 (9-Row 8-Column) 128K x 8-bit x 2 (9-Row 8-Column) |
| 5 | 256K x 16-bit x 1 128K x 16-bit x 1 (8-Row 9-Column) 128K x 8-bit x 2, (8-Row 9-Column) |
| 6 | 1 M x 4-bit x 2 |

Note: The control bit *ALE2* (5Ch.3) must be set while using 16-bit DRAM.

MEMCF - Memory Layout Configuration Register - (write 2Bh)

Bits 7-6: Reserved

Bits 5-4: DBAF[1:0] - DRAM Bus Arbitration Factor

The value in control bits *DBAF1-0* (2Bh.w5-4) defines the DRAM bus arbitration factor, *daf*, which can adjust the number of cycles between two host transfer pre-fetch cycles is at most 2^{daf} . If less bandwidth is demanded by logic other than host transfer, the bandwidth is automatically arbitrated to achieve the best performance. If The value in these bits is 0 after chip reset and firmware reset.

Bit 3: DFRST - Data FIFO Reset

Setting this bit high resets Data FIFO. This bit is not self-clear.

Bit 2: FRDY - Fast Pin IORDY Enable

Setting this bit high accelerates the de-assertion of *pin IORDY* (49) without referring *pin HRDb* (50).



Bit 1-0: RLC[1:0] - External RAM Layout Configuration Bits

The memory layout configuration should be set as shown in the following table:

| RLC[1:0] | Block Size |
|----------|------------|
| 0,1 | -- |
| 2 | C00h |
| 3 | A00h |

The block size should be set as C00h if *C2WEN* (10h.w2) is enabled.

SICTL1 - Subcode Interface Control Register 1 - (write 2Ch)

Bit 7: SBXCK - Subcode External Clock

The external clock from *pin EXCK* (20) is used by the subcode logic if this bit is high.

Bit 6: SCEN - Subcode Enable

Setting this bit high enables the subcode logic.

Bit 5: CD2SC - Clock Divided By 2 For Subcode Logic

The subcode clock is divided by two if this bit is high.

Bit 4: SCIEN - Subcode Interrupt Enable

Setting this bit high enables subcode interrupts.

Bit 3: EXINV - External Clock Invert Select

If *EXOP* (2Ch.w2) is high, setting this bit high selects an inverted clock output at *pin EXCK* (20).

Bit 2: EXOP - Pin EXCK Operation

Setting this bit high sets *pin EXCK* (20) as an output.

Bit 1-0: SCF[1:0] - Subcode Format Select

| SCF[1:0] | Subcode Format |
|----------|----------------|
| 0 | SMD0 (Philips) |
| 1 | SMD1 (EIAJ-1) |
| 2 | SMD2 (EIAJ-2) |
| 3 | Reserved |



MISC0 - Miscellaneous Control Register 0 - (write 2Eh)

Bit 7: HIIEN - Host Interface Interrupt Enable

Setting this bit high enables the microprocessor interrupt of the host interface. Host interface interrupt occurs at the following conditions:

- SRST (Device Control Register) is written as 1 after 0 to either master or slave drive.
- Execute Drive Diagnostics Command is written to either master or slave drive.
- Any opcode is written to the ATAPI Command Register while the drive is selected except: (1) command opcode is 08h, (2) command opcode is A0h and *APKTEN* (18h.7) is high.

IDE interface interrupt is cleared by the following:

- Chip reset or host reset
- Reading register 37h
- Writing 1 to *CLRBSY* (20h.4)

Bit 6: Reserved

Bit 5: DRVEb - Drive Selection Enable

Setting this bit low enables selection of the drive if bit DRV in ATAPI Drive Select Register matches the setting of *MDRV* (2Eh.4).

Bit 4: MDRV - Master Drive

Setting this bit high sets the drive to be selected when bit DRV in the ATAPI Drive Select Register is set to 0 (Master Drive).

Bit 3 : HIRQ - Host Interrupt Request

Set this bit high asserts interrupt at pin HIRQ if the drive is selected and nIEN is enabled in the ATAPI Device Control Register. HIRQ is also automatically set by the following:

- Automatic Packet Transfer sequence, enabled by *APKTEN* (18h.7)
- Automatic Status Completion sequence, enabled by *SCT* (17h.w0) or *ASCEN* (18h.5)

HIRQ is automatically de-activated by the following:

- Chip reset or host reset
- Set bit SRST in the ATAPI Device Control Register high
- Host issue ATA command while the drive is selected
- Host read ATAPI Status Register while the drive is selected

Bit 2: SHIEN - Shadow Command Interrupt Enable

Setting this bit high enables the microprocessor interrupt for the shadow command. *Pin UINTb* (36) becomes low-active when *SHDC* (2Fh.r5) becomes high-active if this bit is enabled.

Bit 1, 0: Reserved



MISS0 - Miscellaneous Status Register 0 - (read 2Eh)

Bit 5: SRUb - Status Register Updated Flag

This bit becomes high when the ATAPI Status Register is updated by the following:

- Microprocessor writes to 37h
- Microprocessor triggers *DSCT* (17h.w5)
- Microprocessor triggers *SCT* (17h.w0)
- Automatic Status Completion occurs if *ASCEN* (18h.5) is enabled
- Reception of A0h command if *APKTEN* (18h.7) is enabled
- Chip reset or host reset

Bit 4: MDRVF - Master Drive Flag

This bit is high if the drive is configured as Master. This bit is low if the drive is configured as Slave.

Bit 3: HINTF - Host Interrupt Flag

This bit reflects the status of the source of *pin HIRQ* (47).

Bit 2: nIEN - Bit nIEN in Device Control Register

This bit reflects the value of bit nIEN in ATAPI Device Control Register.

Bit 1: PDIAGb - Pin PDIAGb Flag

This bit reflects the status of *pin PDIAGb* (43).

Bit 0: DASPb - Pin DASPb Flag

This bit reflects the status of *pin DASPb* (37).

MISC1 - Miscellaneous Control Register 1 - (write 2Fh)

This register is 0 after chip reset.

Bit 7: ARRC - ATAPI Register Read Control

When this bit is high, the ATAPI registers can be read regardless of the value of BSY if the drive is selected.

Bit 6: SARRC - Shadow Drive ATAPI Register Read Control

When this bit is high, the Shadow ATAPI registers can be read regardless of the value of BSY if the shadow drive is selected.

**Bit 5-4: HRSTS[1:0] - HRSTb Pin Function Select**

| HSTS[1] | HSTS[0] | type | function of pin 21 | remark |
|---------|---------|------|--------------------|---------|
| 0 | 0 | I/OD | GIO1 | default |
| 0 | 1 | O | DA1 | |
| 1 | 0 | I | HRSTb | |
| 1 | 1 | I | HRSTb | |

Bit 3-2: ARSTS[1:0] - ARSTb Pin Function Select

| ARSTS[1] | ARSTS[0] | type | function of pin 60 | remark |
|----------|----------|------|------------------------|---------|
| 0 | 0 | I/OD | GIO2 | default |
| 0 | 1 | O | DA2 | |
| 1 | 0 | OD | ARSTb (reset-mode) | |
| 1 | 1 | OD | ARSTb (interrupt-mode) | |

When *ARSTS1* is high, *pin ARSTb (60)* becomes active-low if host writes an ATAPI Soft Reset Command. In interrupt-mode, writing any value to register *ARSTACK (30h,w)* de-activates *pin ARSTb (60)*. In reset-mode, *pin ARSTb (60)* automatically de-activates itself after 256 system clock.

Bit 1: ARSTIEN - ATAPI Soft Reset Interrupt Enable

When this bit is high, *pin UINTb (36)* becomes active-low whenever host writes an ATAPI Soft Reset Command (opcode is 08h).

Bit 0: ARWC - ATAPI Register Write Control

Host writes to ATAPI registers (except Device Control Register) will not take effect when ARWC and BSY are high, if BSY is not set by the following commands:

- Opcode 90h is written to ATA Command Register while the drive is selected.
- Opcode 90h is written to ATA Command Register while the shadow drive is selected if *SHDRV (3Fh.6)* if high.

MISS1 - Miscellaneous Status Register 0 - (read 2Fh)**Bit 7: SRST - Soft Reset Flag**

This bit becomes high when host writes 1 to bit SRST in the ATAPI Device Control Register if either master or slave drive is selected. When SRST becomes high, the following events will be executed:

- BSY (37h.7) ← 1
- Initialize ATAPI signature
- *PDIAGEN (20h.w6)* ← 0 and disables *pin PDIAGb (43)* to high-impedance state



- Disable *pin DASPb (37)* to high-impedance state if *DASPSS (3Fh.0)* is low. Negates *pin DASPb (37)* if *DASPSS (3Fh.0)* is high.
- *CKSTP (19h.7)* ← 0
- Activates host interrupt to the microprocessor if *HIEN (2Eh.w7)* is high.
- *HIRQ (2Eh.w3)* ← 0

Host interrupt is cleared by read register *ATCMD (37h)* or write *CLRBSY (20h.4)*. *SRST* is de-activated by read register *MISS1 (2Fh,r)* after *SRST* is set to low by host.

Bit 6: ATAC - ATAPI Command

If the drive is selected, this bit becomes high when any command is written to the ATAPI Command Register except the following opcode are received.

- opcode is 90h
- opcode is 08h and either *ARST1 (2Fh.w3)* or *ARSTIEN (2Fh.w1)* is enabled
- opcode is A0h and *APKTEN (18h.w7)* is high

ATAC is de-activated by the following:

- Chip reset or host reset
- Reading register *ATCMD (37h)*
- Writing 1 to *CLRBSY (20h.4)*

Bit 5: DIAG - Execute Drive Diagnostics Command

This bit becomes high if Execute Drive Diagnostics Command (opcode 90h) has been written to either master or slave drive. Meanwhile, the following events will be executed:

- *BSY(37h.7)* ← 1
- *PDIAGEN (20h.w6)* ← 0 and disables *pin PDIAGb* to high-impedance state
- *CKSTP (19h.7)* ← 0
- ATAPI Error Register ← 01h
- ATAPI Feature Register ← 00h
- ATAPI Interrupt Reason Register ← 01h
- ATAPI SAM Tag Byte ← 01h
- ATAPI Byte Counter Register Low/High ← 00h
- ATAPI Drive Select Register ← 00h
- Clear ATAPI Status Register except bit *BSY* and *SERVICE*
- Activates host interrupt to the microprocessor if *HIEN (2Eh.w7)* is enabled

**Bit 4: SHDC - Shadow Command Flag**

This bit becomes high when the host writes a command to a non-existent slave drive. Meanwhile, *pin UINTb* (36) becomes low-active if *SHIEN* (2Eh.w2) is enabled. ATAC is de-activated by the following:

- Chip reset or host reset
- Reading register ATCMD (37h)
- Writing 1 to *CLRBSY* (20h.4)

Bit 3: ARST - ATAPI Soft Reset Flag

This bit becomes high when ATAPI Soft Reset command (opcode 08h) is written to either master or slave drive. ARST is de-activated by writing any value to register *ARSTACK* (30h,w).

Bit 2: RST - Reset Flag

This bit is high when the chip is currently being reset by chip reset, host reset, or firmware reset.

Bit 1: FRST - Firmware Reset Flag

This bit is high if the current or most recent reset was firmware reset. The first read of register *MISS1* (2Fh,r) following the end of the firmware reset clears this flag to 0.

Bit 0: HRST - Chip reset or host reset Flag

This bit is high if the current or most recent reset was activated by chip reset or host reset. The BSY flag is set whenever chip reset or host reset is activated. The first read of register *MISS1* (2Fh,r) following the end of the chip reset or host reset clears this flag to 0.

ARSTACK - ATAPI Soft Reset Acknowledge (write 30h)

Writing any value to this register triggers the following events:

- Clears *ARST* (2Fh.r3)
- Deactivates pin *ARSTb* if *ARSTS1-0* (2Fh.w3-2) is 3
- Deactivates pin *UINTb* if *ARSTIEN* (2Fh.w1) is enabled

MISS2 - Miscellaneous Status Register 0 (read 30h)**Bit 7: SRSTD - Soft Reset with DRQ**

This bit becomes high if host activates SRST in the ATAPI Device Control Register while DRQ is high and the drive is selected. This bit is updated at rising edge of SRST.



Bit 6: CMDC - Command Conflict

This bit becomes high if one of the following events occurs while BSY is high:

- Host writes any opcode to ATAPI Command Register while drive is selected.
- Host writes any opcode to ATAPI Command Register while shadow drive is selected and *SHDRV (3Fh.6)* is enabled.
- Host writes opcode 90h (Execute Drive Diagnostics) to ATAPI Command Register.

CMDC is updated each time the host writes the ATAPI Command Register.

Bit 5: TDIR - Data Transfer Direction

| TENDb (01h.r6) | TDIR (30h.r5) | FPKT (30h.1) | Transfer End Reason | Acknowledge register |
|----------------|---------------|--------------|----------------------------|----------------------|
| 0 | 1 | 0 | data-in transfer | DHTACK (0Eh) |
| 0 | 1 | x | data-out transfer | TACK (07h) |
| 0 | 0 | x | A0 command packet transfer | TACK (07h) |

Bit 4: MBTI - Multi-block Transfer Interrupt

This flag indicates the end of each block transfer while the Multi-block transfer is used.

Bit 3: UCRCOKB - Ultra DMA CRCOK/RAM Parity Interrupt Flag

This bit becomes high if an Ultra DMA CRC error is detected at the end of Ultra DMA burst.

Bit 2: CRST - Chip Reset Flag

This bit is set high by chip reset. The first read of register *MISS2 (30h,r)* following the end of the chip reset clears this flag to 0.

Bit 1: FPKT -Full Packet Flag

This bit becomes high if the host has written the number of data bytes indicated in register ATBLO (less than 12 bytes), or the host has written a 12-byte command packet. If CoD (32h.0) is low when DRQ (37h.3) change from 0 to 1, the count in ATBLO is latched as a threshold value for FPKT logic. If CoD is high when DRQ (37h.3) change from 0 to 1, the threshold value of FPKT logic is set as 12. Whenever the number of bytes in the Packet FIFO equals the threshold value, flag FPKT becomes high. To receive data from host using Packet FIFO, CoD (32h.0) and ATBLO (32h) should be updated at rising edge of DRQ.

Bit 0: APKT - Automatic Packet Transfer Flag

This bit is set to 1 when host writes opcode A0h to ATA Command Register if drive is selected and *APKTEN (18h.7)* has been enabled. When this flag is high, BSY is controlled by the Automatic Packet Transfer logic. Hence, setting of *CLRBSY (20h.4)* and *SETBSY (20h.4)* is of no effect. APKT is de-activated by writing any value to register *TACK (07h,w)*. APKT is de-activated by chip reset or host reset but is not changed by firmware reset.



ATERR - ATAPI Error Register (write 31h/read 39h)

This register is set as 01h by the following events:

- Chip reset or host reset
- SRST
- Execute Drive Diagnostics Command
- Triggering *SIGT (17h.w4)*

ATFEA - ATAPI Feature Register (read 31h)

This register is de-activated by the following events:

- Chip reset or host reset
- SRST
- Execute Drive Diagnostics Command
- Triggering *SIGT (17h.w4)*

ATINT - ATAPI Interrupt Reason Register (read/write 32h)

This register is set as 01h by the following events:

- Chip reset or host reset
- SRST
- Execute Drive Diagnostics Command
- Triggering *SIGT (17h.w4)*

ATSPA - ATAPI SAM Tag Bytes Register (read/write 33h)

This register is set as 01h by the following events:

- Chip reset or host reset
- SRST
- Execute Drive Diagnostics Command
- Triggering *SIGT (17h.w4)*

**ATBLO - ATAPI Byte Count Low (read/write 34h)**

This register is set as 14h by chip reset, host reset, SRST or triggering *SIGT (17h.w4)*. This register is set as 00h by Execute Drive Diagnostics Command.

ATBHI - ATAPI Byte Count High (read/write 35h)

This register is set as EBh by chip reset, host reset, SRST or triggering *SIGT (17h.w4)*. This register is set as 00h by Execute Drive Diagnostics Command.

ATDRS - ATAPI Drive Select (read/write 36h)

This register is set as 00h by the following:

- Chip reset or host reset
- SRST
- Execute Drive Diagnostics Command

Note that this register is not changed by triggering *SIGT (17h.w4)*.

ATSTA - ATAPI Status Register (write 37h/read 38h)

This register is set as x0000000b by chip reset, host reset. This register is set as x00x0000b by SRST, Execute Drive Diagnostics Command, or triggering *SIGT (17h.w4)*. Note that BSY is not changed by writing register ATSTA (37h).

ATCMD - ATAPI Command Register (read 37h)

This register is used to latched the command opcode written from host without default value.

ASSTA - ATAPI Shadow Status Register - (write 38h)**Bit 0: SCHECK - Shadow Check Bit**

If configured as a Master drive, the firmware should set SCHECK following each host write to ATCMD to comply with ATAPI specification. Bit-7 of Shadow Status Register is the same as BSY of Status Register. Bit 6-1 of Shadow Status Register are all 0s. SCHECK is deactivated by chip reset, host reset, or host writes to Command Register regardless of which drive is selected.



ASERR - ATAPI Shadow Error Register - (write 39h)

Bit 2: SABRT - Shadow ABRT Bit

The microprocessor should set SABRT following each host write to ATCMD to comply with ATAPI specification if configured as a master drive. The other bits of Shadow Error Register are all 0s..

LDDBL/LDDBH - Latched Decoded Data Block Register - (read 3Ah/3Bh)

The decoded data block number in DDBH/L is latched into LDDBH/L at the end of EDC check. This number is available to the end of next EDC check. The LDDBH/L should not be used if *BICEN* (9Ah.7) is enabled.

APKSTA - Status Register for Automatic Packet Transfer - (write 3Dh)

Bit 4: ADSC - Disk Seek Complete for Automatic Packet Transfer

The value of ADSC is the value of bit DSC in ATAPI Status Register during Automatic Packet Command Transfers.

ASCSTA - Status Register for Automatic Status Completion - (write 3Eh)

Bit 6: ADRDY - Drive Ready for Automatic Status Completion

The value of ADRDY is the value of bit DRDY in the ATAPI Status Register during Automatic Status Completion.

Bit 2: ACORR - Correctable Error for Automatic Status Completion

The value of ACORR is the value of bit CORR in the ATAPI Status Register during Automatic Status Completion. CORR is de-activated by chip reset, host reset, or firmware reset.

Bit 0: ACHECK - Check for Automatic Status Completion

The value of ACHECK is the value of bit CHECK in the ATAPI Status Register during Automatic Status Completion. CHECK is de-activated by chip reset, host reset, or firmware reset.



SHDCTL - Shadow Drive Control Register (read/write 3Fh)

Bit 7, 4, 3: Reserved

Bit 6: SHDRV - Shadow Drive Enable

If *MDRV (2Fh.4)* is high, the bit reflects the level on pin DASPb (43) until *SHDRVL (3Fh.5)* is set high. If this bit is high, Shadow Register support for the non-existent Slave Drive is enabled..

Bit 5: SHDRVL - Shadow Drive Enable Latch

Microprocessor should set this bit high at least 450 milliseconds after chip reset or host reset to latch the setting of *SHDRV (3Fh.6)* from pin DASPb if configured as a master drive. This bit is 0 after chip reset and host reset.

Bit 2: DASPS2 - DASP Select 2

Setting this bit high enables *DASPEN (20h.w5)* during host reset. *DASPS2* should normally be 0 to comply with ATAPI specification. This bit is 0 after chip reset.

Bit 1: DASPS1 - DASP Select 1

Setting this bit high enables *DASPEN (20h.w5)* following end of host reset. This bit is 0 after chip reset.

Bit 0: DASPSS - DASP SRST Select

Setting this bit high enables *DASPEN (20h.w5)* following the end of soft reset (SRST). This bit is 0 after chip reset and host reset.

LSTA0 to LSTA3 - Latched Status Registers - (read 48h to 4Bh)

The contents of *STAT0-3 (0C-0Fh.r)* are latched into these four registers at the end of EDC check. These values are available to the end of next EDC check. These registers should not be used if *BICEN (9Ah.7)* is enabled.

LHD0 to LHD3 - Latched Header Registers - (read 4Ch to 4Fh)

The contents of *HEAD0-3 (04-07h.r)* are latched into these four registers at the end of EDC check. These values are available to the end of next EDC check. These registers should not be used if *BICEN (9Ah.7)* is enabled.



Ring Control Registers - (read/write 50h to 57h)

These eight registers add flexibility to the block control of external memory that is controlled by *RTC2-0 (2Ah.2-0)* initially. Once one of these eight registers is set, all eight registers should be set to take full control of block configuration of the external memory. The data-transfer-ring and write-buffer-ring are normally set the same value.

DTRBL/DTRBH - Data Transfer Ring Base Register - (read/write 50h/51h)

Data Transfer Ring Base Register and Data Transfer Ring Ceiling Register treat the external memory as a ring while transferring data to the host. Data Transfer Ring Base Register specifies the base block number of this ring.

DTRCL/DTRCH - Data Transfer Ring Ceiling Register - (read/write 52h/53h)

Data Transfer Ring Base Register and Data Transfer Ring Ceiling Register treat the external memory as a ring while transferring data to the host. Data Transfer Ring Base Register specifies the ceiling block number of this ring. The first block to be transferred is specified by registers *TBH/L (25h/24h)*. The further data transfer after the end of Data Transfer Ceiling block will access data in Data Transfer Base block.

WBRBL/WBRBH - Write Buffer Ring Base Register - (read/write 54h/55h)

Write Buffer Ring Base Register and Write Buffer Ring Ceiling Register treats the external memory as a ring while buffering the serial data from DSP. Write Buffer Ring Base Register specifies the base block number of this ring.

WBRCL/WBRCH - Write Buffer Ring Ceiling Register - (read/write 56h/57h)

Write Buffer Ring Base Register and Write Buffer Ring Ceiling Register treats the external memory as a ring while buffering the serial data from DSP. Write Buffer Ring Base Register specifies the base block number of this ring. The first block to be buffered is specified by registers *DDBH/L (29h/28h)*. Further serial data buffering after the end of Write Buffer Ceiling block will buffer serial data into the Write Buffer Base block.



PSKCTL - Programmable System Clock Control Register - (read/write 59h)

This register should be set before the programmable system clock is enabled by setting *PSKEN* (1Ah.w4) high. This register is 0 after chip reset.

Bit 7: PSKSEL (write) - Programmable System Clock Select

If this bit is high, the internal system clock will be adjusted to fit the programmed frequency according to Crystal input. If this bit is low, the internal system clock will be adjusted to fit the programmed frequency according to internal clock.

Bit 7: LOCKED (read) - Programmable System Clock Locked

This bit is high once the internal system clock is ever on lock with the programmed frequency.

Bit 6: LOCKSEL (write) - Programmable System Clock Lock Select

If this bit is high, the internal system clock will keep the same delay path once the programmed frequency is locked. This function keeps system clock at steady frequency, but the frequency may be affected by temperature. If this bit is low, the internal system clock will be continuously adjusted to fit the programmed frequency according to Crystal input and result in a various frequency.

Bit 6: ONLOCK (read) - Programmable System Clock On Lock

This bit is high if internal system clock is on lock with the programmed frequency.

Bit 5-0: PSK[5:0] - Programmable System Clock Factor

If *PSKEN* (1Ah.w4) and *PSKSEL* (59h.w7) are high, these six bits are used to controlled the internal system frequency. The equation is:

$$\text{frequency system clock} = \text{frequency of XIN} \cdot (\text{PSK}[5:0] + 2) \cdot 16$$

SCTC - Subcode Timer Control Register - (write 5Ah)

If *SBXCK* (2Ch.w7) and *CD2SC* (2Ch.w5) are both low, the clock used by subcode logic clock is controlled by *SUBCS2-0* (21h.w2-0) unless any non-zero value is written into this register. The value of this register should be calculated as follows:

$$(N + 2) \times tc \times dsf = 11.3 / 2$$

where *tc* is the internal clock period(ex: 50nS for 20MHz crystal),

dsf is the disk speed factor(ex: 4 for 4-fold speed drive).

There is no need to set this register if *SBCK* (88h.w3) is set high.

EFCTL - Enhanced Feature Control Register - (read/write 5Bh)

Bit 7: ASDMA - Automatic Set DMA

If this bit is high, the inverted value of DMA bit of *ATFEA* (1F1h,w) will be automatically loaded to *PIO* (1Fh.2). This bit is 0 after chip reset, host reset and firmware reset.



Bit 6: ASRIT - Alternate SR1b Timing (obsolete function)

Bit 5: DSP1STB

Bit 4: reserved

Bit 3: ALERT - Alternate Latch Registers Timing (obsolete function)

Bit 2: Reserved

Bit 1: DRA - Direct Register Addressing Enable

If this bit is set high, the Direct Register Addressing function is enabled. This bit is 1 after chip reset in normal condition. But if *pin RA8 (92)* is connected to a 4.7K Ω pull-down resistor, this bit is set high after chip reset. This alternative power-on setting provides a way to do conventional indirect register addressing.

Bit 0: Reserved

Power-On Setting of Register Addressing Mode

The default register addressing mode of W88113CF is direct register addressing mode.

| Alternative Power-On Setting | | | | |
|--------------------------------|--------------------------------|---------------------------|---------------|------------------------|
| RA8 pull-down 4.7K Ω | RA7 pull-down 4.7K Ω | Direct Register Select | ALE input pin | 16-bit DRAM support |
| no (default) | no (default) | yes | ALE2 | yes |
| no | yes | yes | ALE1 | no |
| yes | no | no | x | yes |
| yes | yes | no | x | no |

EFCTL2 - Enhanced Feature Control Register 2- (read/write 5Ch)

Bit 7-4: Reserved

Bit 3: ALE2 - ALE2 Enable

When this bit is set high, *pin ALE2 (64)* is used as ALE input. This bit is 1 after chip reset in normal condition. But if *pin RA7 (93)* is connected to a 4.7K Ω pull-low resistor, this bit is set low after chip reset.

Bit 2: SYNCP - Sync Bytes Patch Enable

If this bit is high, the sync bytes of the following sector are patched to the previous sector. This bit must be disabled when reading CD-DA data.



Bit 1: reserved

Bit 0: RMSRI - Remove Frequent SRib

If *RMSRI (5Ch.0)* is high, flag *SRib (01h.r5)* is generated only by flags *STAERR (80h.r6)*, *DSFULI (80h.r4)*, *LASTBK (80h.r3)*, *LTTI (80h.r2)*, *TNFI (80h.r1)* or *HCEI (80h.r0)*. Setting this bit high can reduce the overhead of microcontroller while the automatic cache management is used. This bit is 0 after chip reset, host reset and firmware reset.

LSUBH2 - Latched Subheader 2 Register - (read 5Dh)

The content of Subheader-2-Register(16h) is latched into this register at the end of EDC check. This value is available to the end of next EDC check.

PSKCNT - Programmable System Clock Internal Counter (read 5Eh)

Bit 4-0 of this register hold the internal counter of programmable clock system. This value can be read for ststem debug.

GIOCTL - General I/O Port Control Register - (read/write 5Fh)

Pin HRSTb (21) can be configured as GIO1 by *HRSTS1-0 (2Fh.5-4)*. *Pin ARSTb (60)* can be configured as GIO2 by *ARSTS1-0 (2Fh.3-2)*. This register is 0 after chip reset.

Bit 7-6: reserved

Bit 5: G2OEN - General I/O Port 2 Output Enable

Setting this bit high configure GIO2 as output. Otherwise, it is an input pin.

Bit 4: G1OEN - General I/O Port 1 Output Enable

Setting this bit high configure GIO1 as output. Otherwise, it is an input pin.

Bit 3: reserved

Bit 2: GIN3 - General Input Port 3

The pin state of *URS (32)* can be read back from this bit if *DRA (5Bh.1)* is high and *DA0EN (87h.7)* is low.

Bit 1: GIO2 - General I/O Port 2

If GIO2 is configured as an input pin, the pin state can be read back from this bit. If GIO2 is configured as an output pin, set this bit low drive GIO2 low and set this bit high cause a weak pull-up.

Bit 0: GIO1 - General I/O Port 1

If GIO1 is configured as an input pin, the pin state can be read back from this bit. If GIO1 is configured as an output pin, set this bit low drive GIO1 low and set this bit high cause a weak pull-up.

TARCTL - Target Control Register - (write 80h)

This register is used to control the automatic target search and header comparison. Since these control bits are not changed by closing decoder, there is no need to write it before every time the decoder is enabled.

Bit 7: TARGEN - Target Function Enable

Setting this bit high enables target search function but does not enable decoder simultaneously. The operation of target search is triggered by setting *DECEN* (0Ah.w7) high. Then the decoder generates first interrupt after the target sector, specified by *TARGET* (84h-86h), is found.

Bit 6: DSCEN - Decoding Sector Counting Enable

If *DSCEN* (80h.6) is enabled, flag *DSFULI* (80h.r4) becomes high if *DSCL* (81h,r) is equal to *DSTL* (81h,w) at the end of EDC-checking.

Bit 5: QEN - Q-channel extraction enable

Setting this bit high enables Q-channel extraction logic. This pin should be set high only when *SCEN* (2Ch.w6) is high. Once decoder and Q-channel extraction are both enabled, the extracted Q-channel bytes are written into the DRAM starting from offset 9E0h of each block regardless of what mode of data is set.

Bit 4: QMSF - Q-channel MSF auto-load enable

If Q-channel extraction logic is enabled, setting this bit high enables the MSF bytes of Q-channel to be automatically loaded to *HEAD0-2* (04h-06h,r).

Bit 3: ASTOPB - Automatic Decoder Stop on Error

If this bit is low, decoder would automatically stop on the following conditions:

- *HCEI* (80h.r0) activates if *HCEEN* (80h.w0) is enabled.
- *TNFI* (80h.r1) activates if *TNFEN* (80h.w1) is enabled.
- *LTTI* (80h.r2) activates if *LTTEN* (80h.w2) is enabled.
- *LASTBK* (80h.r3) activates if *BLIMEN* (9Ah.5) is enabled
- *DSFULI* (80h.r4) activates if *DSCEN* (80h.w6) is enabled.
- *STAERR* (80h.r6) activates if any Status Mask Bit is enabled

If this bit is low, the consistency of f/w and h/w should be carefully maintained. If this bit is high, the decoder is controlled by microprocessor. This bit is default low after chip reset.

Bit 2: LTTEN - Larger Than Target Interrupt Enable

Setting this bit high enables *LTTI* (80h.r2) to be reflected on *SRIB* (01h.r5).

Bit 1: TNFEN - Target Not Found Interrupt Enable

Setting this bit high enables *TNFI* (80h.r1) to be reflected on *SRIB* (01h.r5).

Bit 0: HCEEN - Header Compare Error Interrupt Enable

Setting this bit high enables *HCEI*(80h.r0) to be reflected on *SRIB* (01h.r5).

TARSTA - Target Status Register - (read 80h)

This register is 0 after chip reset, host reset, firmware reset and decoder reset. Reading this register deactivates *SR1b* (01h.r5).

Bit 7: TARGED - Target Is Found

This bit is high after the target is found.

Bit 6: STAERR - Status Error Flag

This bit becomes high if any status bit error, enabled by its corresponding mask bit, occurs at the end of EDC-checking. This flag is deactivated after reading register *TARSTA* (80h,r).

Bit5: BIN0 - Block Indicator Is Not Zeror Flag

If *BINOM* (8Ch.w1) is high, This bit becomes high if the block indicator in *HEAD3* (07h.r7-5) is not zero. This flag also activates *STAERR* (80h.r5) high.

Bit 4: DSFULI - Decoding Sector Full Interrupt Flag

If *DSCEN* (80h.6) is enabled, this flag becomes high if *DSCL* (81h,r) is equal to *DSTL* (81h,w) at the end of EDC-checking.

Bit 3: LASTBK - Last Decoded Block

If *BLIMEN* (9Ah.5) is high, this bit is set when the last pre-buffered block is decoded. Firmware should disable decoder when detect this flag. The DSP buffering stop when buffer-cache full.

Bit 2: LTTI - Larger Than Target Interrupt Flag

If *LTTEN* (80h.w2) and *TARGEN* (80h.w7) are high, this flag becomes high if the header larger than target when *HEAD0-2* (04h-06h) are available. This flag is deactivated after reading register *TARSTA* (80h,r).

Bit 1: TNFI - Target Not Founded Interrupt Flag

This bit becomes high if the headers in *HEAD0-2* (04h-06h) never match the target after *N* successive comparisons. Where *N* is the search limit number specified by *TSL* (83h,w). If *TNFEN* (80h.w1) is high, *SR1b* (01h.r5) activates when this bit becomes high. If *ASTOPb* (80h.w3) is low, this event also clears *DECEN* (0AH.w7) and stop the decoder automatically. This flag is deactivated after reading register *TARSTA* (80h,r). The microprocessor could read out the header after event occurs to determine the distance from target.

Bit 0: HCEI - Header Compare Error Interrupt Flag

After target is founded, the number in *TARGET* (84h-86h) will automatically increment after *HEAD0-2* (04h-06h) are available. If the headers of following sector do not match the target, this bit becomes high and activates *SR1b* (01h.r5) if *HCEEN* (80h.w0) is enabled. It also clears *DECEN* (0AH.w7) and stop the decoder automatically if *ASTOPb* (80h.w3) is low. This flag is deactivated after reading register *TARSTA* (80h,r).



DSTL - Decoding Sector Threshold Register - (write 81h)

If *DSCEN* (80h.w6) is enabled, this register specifies the threshold number of successive sectors minus one to be decoded after header is targeted. Flag *DSFULI* (80h.r4) becomes high when value in *DSCL* (81h,r) is equal to *DSTL* (81h,w) at the end of EDC-checking. The initial value of *DSTL* (81h,w) is FFh after chip reset, firmware reset and decoder reset. Note that threshold value should not be set as 00h if *DSCEN* (80h.w6) is enabled.

DSTH - Obsolete (write 82h)

DSCL - Decoding Sector Counter - (read 81h)

Once the target header is found, this counter increments when a sector is completely decoded. This counter is incremental-only, and the value follows FFh is 0. If *DSCEN* (80h.w6) is high, flag *DSFULI* (80h.r4) becomes high if *DSCL* (81h,r) is equal to *DSTL* (81h,w) at the end of EDC-checking. Meanwhile, the decoder stops if *ASTOPb* (80h.w3) is low.

This register is cleared to 00h at the falling edge of *DECEN* (0Ah,w7).

The initial value of DSCL after chip reset, firmware reset and decoder reset is 00h.

DSCH - Obsolete (read 82h)

TSL - Target Search Limit Register - (write 83h)

This register specifies the limited number of target search. If *N* is the number specified by this register, *TNFI* (80h.r1) becomes high if the headers have not match the target after *N* successive sectors. Since this register will not be changed by decoding operation, there is no need to writing it before every decoding operation. The initial value of TSL after chip reset, host reset and firmware reset is FFh.

TSC - Target Search Counter - (read 83h)

After the decoder is enabled, the number of sectors has been searched can be monitored by reading TSC. This register is cleared to 00h at the falling edge of *DECEN* (0Ah,w7). The initial value of TSC after chip reset, firmware reset and decoder reset is 00h.



TARGET0 - Target Minute Register - (read/write 84h)

TARGET1 - Target Second Register - (read/write 85h)

TARGET2 - Target Frame Register - (read/write 86h)

DACTL - Digital Audio Control Register - (read/write 87h)

This register is 00h after chip reset and host reset.

Bit 7: DA0EN - Digital Output 0 Enable

If this bit is high, the digital audio data output through *pin URS/DA0 (32)*.

Bit 6: CTLSEL - Control Bit Source Select

If this bit is high, the 4 control bits of Q channel are defined by *QCTL3-0 (87h,3-0)*. Otherwise, these 4 control bits are extracted from external RAM. This bit is normal set low if the Q-channel extraction work properly.

Bit 5-4: ACCU[1:0] - Clock Accuracy

These two bits are used as clock accuracy bits in digital audio output. These two bits are usually set 00b.

Bit 3:0: QCTL[3:0] - Control Bits for Q Channel

If *CTLSEL (87h.6)* is high, these four bits are used as Q channel control bits in digital audio output.

FEACTL - Feature Control Register - (read/write 88h)

This register is 00h after chip reset and host reset.

Bit 7: LECAS - Latch Data with External CAS Signal

If this bit is high, input DRAM data is latched by external CASH/L signal instead of rising edge of internal clock. This function can eliminate the timing difference between DRAM data and its latch signal caused by various internal chip delays, depending on circumstances. This function should not be used if *EDOEN (88h.1)* is high.

Bit 6: LREF - Long Refresh Cycle

If this bit is high, the tRAS is 2.5 clocks instead 1.5 clocks for refresh cycle.

Bit 5: MRCD - Medium RAS to CAS Delay

The bit controls the timing of tRCD and tRP. If this bit is high the tRAS for RAS-only refresh is 2 clocks and CAS-Before-RAS is not affected (1.5 clocks).

Bit 4: SDBS - Subcode and DSP Block Synchronization

This bit provides block synchronization of CD-DA format data. If this bit is high, the buffering of incoming serial data and subcode to the external RAM will synchronize to the same block defined by *DDBH/L (29h/28h)*.



Bit 3: SBCK - Select BCK as subcode clock

When this bit is high, the *pin BCK (10)* is selected as subcode reference clock instead of system clock. This setting is suitable for drive using CAV subcode.

Bit 2: CAS8B - Eight CAS in One RAS Enable

When this bit is set low, maximum the number of Column Address Strobe is 8 instead of 4 in one DRAM FPM cycle.

Bit 1: FRCDB - Fast RAS to CAS Delay

The bit controls the timing of t_{RCD} and t_{RP} .

Bit 0: EDOEN - EDO DRAM Support Enable

Setting this bit enables EDO DRAM support and the data latch timing of DRAM changes to falling edge instead of rising edge of internal clock.

DRAM Timing Setting

The timing of DRAM is controlled by *MRCDB (88h.5)* and *FRCDB (88h.1)*. The slower timing may be required to support some slower DRAMs.

| MRCDB | FRCDB | t_{RCD} | t_{RP} | t_{PC} | Minimum Cycle |
|-------|-------|-----------|----------|----------|---------------|
| 0 | 0 | 1 T | 1.5 T | 1 T | 3 T |
| 0 | 1 | 2 T | 1.5 T | 1 T | 4 T |
| 1 | 0 | 1.5 T | 1 T | 1 T | 3 T |
| 1 | 1 | x | x | x | x |

Where T is the system clock period.

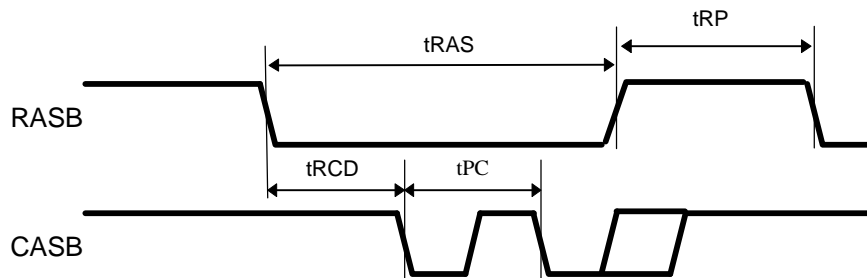

DRAM Timing



DFFCNTL - Data FIFO Threshold Control Register - (read/write 89h)

Bit 7,6: Reserved

Bit 5-3: DFFHT[2:0] - Data FIFO High Threshold

When the number of bytes in Data FIFO larger than DFFHT, device stops pre-fetch to prevent FIFO overrun. Since the default setting of CAS8B (88h.2) is low, the default value of DFFHT is 001b.

| DFFHT[2:0] | Threshold | |
|------------|-----------|---------|
| 000b | 28 | |
| 001b | 24 | default |
| 011b | 16 | |

Bit 2-0: DFFLT[2:0] - Data FIFO Low Threshold

When the number of bytes in Data FIFO less than DFFLT, device de-activates DMARQ to prevent FIFO underrun in traditional DMA mode. When the number of bytes in Data FIFO less than DFFLT, device would stop issuing DSTROBE to prevent FIFO underrun in Ultra DMA data-in mode.

| DFFLT[2:0] | Threshold | |
|------------|-----------|---------|
| 000b | 4 | default |
| 001b | 8 | |
| 011b | 16 | |

ATCTL - Auxiliary Timing Control Register - (read/write 8Ah)

This register is set 00h after chip reset, host reset and firmware reset.

Bit 7: XOFF - Crystal Off

Setting this bit high can turn off the crystal cell and save power consumption. XOFF is de-activated by the following events:

- Chip reset or host reset or firmware reset
- Command write from the host while the drive is selected
- Host issues Diagnostic Command, regardless of drive selection
- Host issues command to shadow drive if SHDRV (3Fh.6) is enabled
- Host set bit SRST in ATAPI Device Control Register high, regardless of drive selection

Bit 6: reserved.



Bit 5-4: UDT[1:0] - Ultra DMA Timing Control

These two bits define the Ultra DMA Timing Factor, **udtf**, which control the timing of Ultra DMA transfer.

$$T_{cyc} = (2 + \mathbf{udtf}) \times T_{udma}$$

where T_{udma} is clock period that depends on setting of *UCLKS (8Ah.3)* and T_{cyc} is Ultra DMA cycle time (from DSTROBE edge to DSTROBE edge)

Device firmware should set **udtf** according to the clock source and the assigned Ultra DMA transfer mode after host issues SET FEATURE command. If there are frequent CRC errors in data-in bursts, device firmware may switch system to slower Ultra DMA mode by increasing **udtf** to improve data integrity.

Example: If *UCLKS (8Ah.3)* is low and system clock is 33.8688MHz, the **udtf** should be the following value to abide by the determined Ultra DMA mode.

| Ultra DMA | Tcyc Min. Spec. | Tcyc | udtf |
|-----------|-----------------|---------|-------------|
| Mode 0 | 114 ns | 118 ns | 2 |
| Mode 1 | 75 ns | 88.6 ns | 1 |
| Mode 2 | 55 ns | 59 ns | 0 |

Bit 3: UCLKS - Ultra DMA Clock Select

If this bit is high, the clock source for UDMA is from *pin ACLK (46)*. If this bit is low, the clock source is system clock.

Bit 2-0: REFT[2:0] - Refresh Timing Control

The frequency of refresh is controlled by *REFT2-0 (8Ah.2-0)* to support long refresh. The value after chip reset is 0. The refresh cycle defaults to be issued once after 256 system clocks.

$$\text{refresh period} = 256 \times 2\text{reft system clock periods}$$

STA0M - Status 0 Mask Register - (write 8Ch)

If any following bit is enabled, the flag *STAERR (80h.r6)* becomes high when the corresponding status bit becomes active.

Bit 7 - CRCOK Mask

Bit 6 - ILSYNC Mask

Bit 5 - NOSYNC Mask

Bit 4 - LBLK Mask

Bit 3 - WSHORT Mask

Bit 2 - SBLK Mask

Bit 1 - BIN0 Mask

Bit 0 - UCEBLK Mask



STA1M - Status 1 Mask Register - (write 8Dh)

If any following bit is enabled, the flag *STAERR* (80h.r6) becomes high when the corresponding status bit becomes active.

Bit 4: HDERA Mask

Bit 0: SHDER Mask

STA2M - Status 2 Mask Register - (write 8Eh)

If any following bit is enabled, the flag *STAERR* (80h.r6) becomes high when the corresponding status bit becomes active.

Bit 2: NOCOR Mask

Bit 1: RFOMR1 Mask

STA3M - Status 3 Mask Register - (write 8Fh)

If any following bit is enabled, the flag *STAERR* (80h.r6) becomes high when the corresponding status bit becomes active.

Bit 5: CBLK Mask

Bit 4: ECCINC Mask

Bit 1: C2BLK Mask

APCNF - Audio Playback Configuration Register - (read/write 90h)

The default value of this register is 00h after chip reset, host reset and firmware reset.

Bit 7: APEN - Audio Playback Enable

Setting this bit high enables audio playback logic. Once audio playback logic is enabled, the buffered data will be sent out block after block starting from the setting of *APBK* (92h/93h). The playback stops immediately and keeps "mute" once this bit is set low.

Bit 6: APIEN - Audio Playback Interrupt Enable

Setting this bit high enables audio-playback-interrupt to be reflected on *pin UINTb* (36) whenever each block playback is finished. Audio-playback-interrupt flag is reflected on *APIb* (01h.r2) if *APOUT1-0* (90h, 1-0) is not zero.



Bit 5: APDIRECT - Audio Direct Playback

Setting this bit high directs the original DSP signals to the audio playback pins.

Bit 4: APINS - Audio Reference Input Select

If this bit is set low, *pin ACLK (46)* is used as audio-playback reference clock. If this bit is high, system clock is used as audio-playback reference block.

Bit 3,2: APIN[1:0] - Audio Input Reference Clock Setting

| APIN[1] | APIN[0] | Input Reference Clock |
|---------|---------|-----------------------|
| 0 | 0 | 8.4672MHz |
| 0 | 1 | 16.9344MHz |
| 1 | 0 | 33.8688MHz |
| 1 | 1 | 67.7376MHz |

The value in these registers should be properly set according to the audio-playback reference clock before enable *APEN (90h.7)*.

Bit 1,0: APOUT[1:0] - Audio Data Output Setting

| APOUT[1] | APOUT[0] | Audio Data Output Pin | Pin 6 | Pin 13 |
|----------|----------|-----------------------|-----------|--------|
| 0 | 0 | No Output | tri-state | CLKO |
| 0 | 1 | ROEB/ASD1(84) | ABCK | ALRCK |
| 1 | 0 | ASD0(58) | | |
| 1 | 1 | RD8/ASD2(86) | | |

When APOUT1-0 are set zero, no output is generated from *pin ABCK (6)* and *pin CLKO/ALRCK (13)* is used as left-right clock output. When APOUT1-0 are set not zero, flag *APIb (01h.r2)* becomes low whenever one block audio-playback is finished.

Setting *APIC (99h.0)* high tri-state the associated audio-playback output pin, including ALRCK, ABCK and ADAT, with weak pull-up.

APFMT - Audio Playback Format Register - (read/write 91h)

| | |
|-----------|-------------------|
| APFMT7-0 | Audio Data Format |
| 000xx111h | Toshiba |
| 001xx100h | Sanyo |
| 101xx011h | Sony 48-bit slot |
| 110xx011h | Philip |

| APFMT4 | APFMT3 | Functions |
|--------|--------|-----------------|
| 0 | 0 | Normal Stereo |
| 0 | 1 | Mono Right |
| 1 | 0 | Mono Left |
| 1 | 1 | Left/Right Swap |

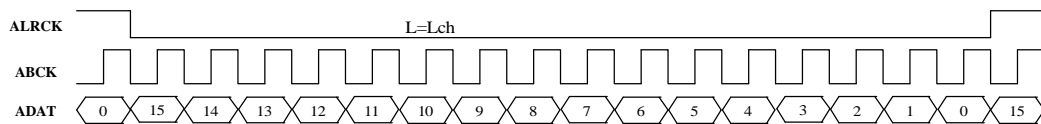

TOSHIBA Audio Format
APFMT(91h) = 07h

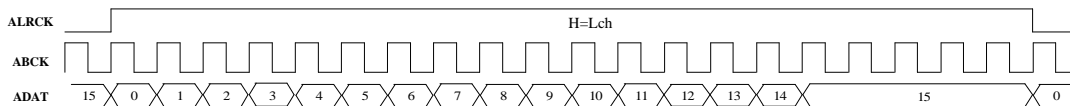

SANYO Audio Format
APFMT(91h) = 24h

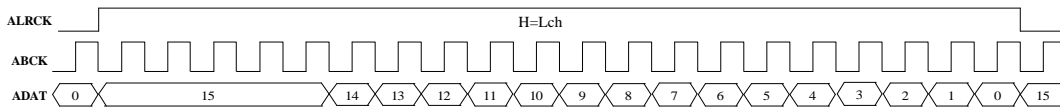

SONY Audio Format
APFMT(91h) = A3h

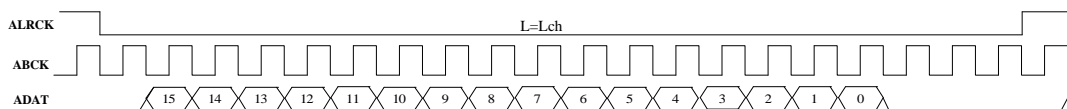

PHILIPS Audio Format
APFMT(91h) = C3h

APBKL/H - Audio Playback Block Register - (read/write 92h/93h)

The bit-0 of *APBKH* (93h) and bit7-0 of *APBKL* (92h) form a 9-bit counter. The value in this 9-bit counter defines the first block to be played back when *APEN* (90h.7) is enabled. The value in these registers is incremented by 1 after one block playback is finished.

93h.Bit-4: BUFCWEN - BUFC Write Enable (obsolete)



APWCL/H - Audio Playback Word Count Register - (read/write 94h/95h)

The number in this counter plus one is the word count to be played back for each memory block. The default value of these registers is **0497h** after chip reset, host reset and firmware reset. No need to change this value for normal usage.

APVOL - Audio Playback Volume Register - (read/write 96h)

Bit 7-4: LVOL[3:0] - Left Channel Volume Control

Bit 3:0: RVOL[3:0] - Right Channel Volume Control

| LVOL3-0/RVOL3-0 | Binary Number | Attenuation (dB) |
|-----------------|---------------|------------------|
| Fh | FFh | 0 (On) |
| Eh | F0h | -0.56 |
| Dh | E0h | -1.16 |
| Ch | C0h | -2.50 |
| Bh | 80h | -6.00 |
| Ah | 40h | -12.0 |
| 9h | 20h | -18.0 |
| 8h | 10h | -24.0 |
| 7h | 0Fh | -24.6 |
| 6h | 0Eh | -25.2 |
| 5h | 0Ch | -26.6 |
| 4h | 08h | -30.0 |
| 3h | 04h | -36.0 |
| 2h | 02h | -42.1 |
| 1h | 01h | -48.0 |
| 0h | 00h | Mute (Off) |

APACK - Audio Playback Interrupt Acknowledge - (write 97h)

Writing any value to this register deactivates flag *APIb (01h.r2)* and its corresponding interrupt.



PUCTL - Pull Up Resistor Control Register - (write 98h)

This register is used to control the utilization of two pull-up resistors on IO cells. Default value is 0.

Bit 7-6: HIP[1:0] - Host Interface Pull-up Control

Setting these two bits low control two pull-up resistors of host interface I/O cells respectively. If these two bits are both high, no pull-up resistors exist. Note that DD7 is controlled by *DD7UPB (98h.1)* separately,

Bit 5-4: UIP[1:0] - Microprocessor Interface Pull-up Control

Setting these two bits low control two pull-up resistors of uP interface I/O cells respectively. If these two bits are both high, no pull-up resistors exist.

Bit 3-2: RIP[1:0] - RAM Interface Pull-up Control

Setting these two bits low control two pull-up resistors of RAM interface I/O cells respectively. If these two bits are both high, no pull-up resistors exist.

Bit 1: DD7UPB - DD7 Pull-up Enable

Setting this bit low disable the internal pull-up resistor on the *pin DD7 (74)*.

Bit 0: APIPB - Audio Playback Interface Pull-up Control

Setting this bit low enable the internal pull-up of the audio-playback output pin, including ALRCK, ABCK and ADAT.

SICTL - Sink Current Control Register - (write 99h) - obsolete



BICCTL - Buffer Independent Correction Control Register - (read/write 9Ah)

This register is 0 after chip reset, host reset and firmware reset.

Bit 7: BICEN - Buffer Independent Correction Enable

If this bit is high, the *buffer-independent-correction (BIC mode)* is enabled. Otherwise, the *real-time-correction (RTC mode)* is enabled.

Bit 6: ATMSEN - Automatic Mode Switch

If this bit is high, the decoder automatically change from Disk-Monitor Mode to the pre-set Buffer-Mode after the target is found.

Bit 5: BLIMEN - Buffer Limit Enable

If *BLIMEN (9Ah.5)* is high, the buffering of DSP data stops when the condition defined by *BLIMS (9Ah.4)* is met. This function should be enabled if *BICEN (9Ah.7)* is set high.

Bit 4: BLIMS - Buffer Limit Source Select

If *BLIMS (9Ah.4)* is high, the buffering stop when *BUFC (9Bh,r)* reach *BUFLIM (9Bh,w)*. If *BLIMS (9Ah.4)* is low, the buffering stop when buffering block (internal) reach *TBH/L (24h/25h,r)* minus 1.

Bit 3-0: RCLIM[3:0] - Repeat Correction Limit

If *BICEN (9Ah.7)* is high, these four bits specify the maximum number of repeat correction.

BUFLIM - Buffer Limit Register - (write 9Bh)

This register is used as buffer limit when *BLIMS (9Ah.4)* is high. If *BUFCWEN (92h.w4)* is low, this register can be set the buffer-ring size minus n , where n is larger than 1. This register is 0 after chip reset, host reset and firmware reset. In normal operation, this register only needs to be set once after power-on.

BUFC - Buffer Counter - (read 9Bh)

This counter increments when a sector is buffered into external RAM. If *ACMEN (9Ch.6)* is high, *BUFC (9Bh,r)* decrements at the end of each data-in block transfer unless the value is zero. The value follows 0 is 0. The transfer of working area data should be implemented as linear transfer to prevent extra decrement of this counter.

If *ACMEN (9Ch.6)* is high, *BUFC (9Bh,r)* minus N right after *SKIPC (9Eh)* is set N . This function can be used to implement the cache-partial-hit event.

If both *BLIMEN (9Ah.5)* and *BLIMS (9Ah.4)* is high, the buffering stop when this count reaches *BUFLIM (9Bh,w)*. The value in *BUFC (9Bh,r)* may exceed *BUFLIM (9Bh,w)* by one.

This counter is synchronized to *TCC (9Dh)* whenever *DECEN (0Ah.w7)* is low.

This counter is 0 after chip reset, host reset and firmware reset.



ACCTL - Automatic Cache Control Register - (read/write 9Ch)

This register is 0 after chip reset, host reset and firmware reset.

Bit 7: ATTEN - Automatic Transfer Trigger Enable

The control bit *ADTT* (17h.w2) is automatically set high if all the following conditions are met:

- *ATTEN* (9Ch.7) is high
- *TCC* (9Dh) is not zero
- *TTC* (9Fh) is not zero

Bit 6: ACMEN - Automatic Cache Management Enable

If *ACMEN* (9Ch.6) is high, the following functions are enabled:

- *TBKHL* (25h/24h) increments at the end of each data-in block transfer
- *TCC* (9Dh) and *TTC* (9Fh) decrements at the end of each data-in block transfer
- *TCC* (9Dh) minus *N* and *TBKHL* (25h/24h) plus *N* right after *SKIPC* (9Eh) is set *N*

If *ACMEN* (9Ch.6) is high and *TTC* (9Fh) is not zero, the following functions are executed when *ADTT* (17h.w2) is triggered:

- $MBC4-0$ (12h.4-0) $\leftarrow \min\{ATLIM$ (9Ch.4-0), *TCC* (9Dh), *TTC* (9Fh) $\}$ minus 1
- $ATBHI/LO$ (35h/34h) $\leftarrow (MBC4-0 + 1) \cdot (TWCH/L + 1) \times 2$ if *STWCEN* (18h.3) is high

Registers *SKIPC* (9Eh) and *TTC* (9Fh) are stuck at 0 if *ACMEN* (9Ch.6) is low.

Bit 5: TCINCEN - Transfer Cache Increment Enable

When this bit is high, the *TCC* (9Dh) increments at the end of EDC-checking if there is no *STAERR* (80h.r6) or *HCEI* (80h.r0) error. This bit should be high if *TCC* (9Dh) is used to implement cache management.

Bit 4-0: ATLIM[4:0] - Automatic Transfer Block Limit

If *ACMEN* (9Ch.6) is high and *TCC* (9Fh) is not zero, these five bits specify the maximum number of blocks that can be transferred to host in one trigger. The minimum limit is 1. Setting 0 to these bits specify limit as 32 blocks.

TCC - Transfer Cache Counter - (read/write 9Dh)

This counter can be used to implement cache management if *RMSRI* (5Ch.0) is high. If *TCINCEN* (9Ch.5) is high, *TCC* (9Dh) increments at the end of EDC-checking if there is no *STAERR* (80h.r6) or *HCEI* (80h.r0) error. If *ACMEN* (9Ch.6) is high, *TCC* (9Dh) decrements at the end of each data-in block transfer unless the value is zero. The value follows 0 is 0. The transfer of working area data should be implemented as linear transfer to prevent extra decrement of this counter.

If *ACMEN* (9Ch.6) is high, *TCC* (9Dh) minus *N* right after *SKIPC* (9Eh) is set *N*. This function can be used to implement the cache-partial-hit event.

This register is 0 after chip reset, host reset and firmware reset. This counter should be set 0 in cache-miss case. Writing this register should be prevented when the decoder is on or the data-in transfer is in progress.



SKIPC - Skip Count - (read/write 9Eh)

This register is used as skip count to implement a partial-hit event of transfer cache. If *ACMEN* (9Ch.6) is high, the following functions are executed right after *SKIPC* (9Eh) is set **N**:

- *BUFC* (9Bh,r) minus **N**
- *TCC* (9Dh) minus **N**
- *TBH/L* (25h/24h) plus **N**
- *SKIPC* (9Eh) minus **N**

After execution of the above operations, the value in *SKIPC* (9Eh) is 0.

This register is 0 after chip reset, host reset and firmware reset. This register is stuck at 0 if *ACMEN* (9Ch.6) is low.

TTC - Total Transfer Count - (read/write 9Fh)

This register is used as total transfer count. If *ACMEN* (9Ch.6) is high, *TTC* (9Fh) decrements at the end of each data-in block transfer unless the value is zero. The value follows 0 is 0. The following events are generated at the end of data-in transfer only if *TCC* (9Fh) is zero:

- *TENDb* (01h.r6) ← 0
- Automatic Status Complete Sequence if *ASCEN* (18h.5) is enabled

This register is 0 after chip reset, host reset and firmware reset. This register is stuck at 0 if *ACMEN* (9Ch.6) is low.



3. REGISTER TABLE

Note that this table is MSB leading.

| INDEX | TYPE | name | bit7 | bit6 | bit5 | bit4 | bit3 | bit2 | bit1 | bit0 | |
|-------|------|--------|----------------------|--------|--------|-------|--------|--------|--------|--------|------|
| - | r/w | IR | index | | | | | | | | |
| 00h | r | PFAR | b7 | b6 | b5 | b4 | b3 | b2 | b1 | b0 | |
| 01h | w | INTCTL | pfneen | tenden | srien | 0 | 0 | 0 | dten | x | |
| 01h | r | INTREA | pfne | tend | srib | hcib | tbsyb | apib | dfrdyb | scib | |
| 02h | r/w | TWCL | b7 | b6 | b5 | b4 | b3 | b2 | b1 | b0 | |
| 03h | w | TWCH | latxf | 0 | 0 | 0 | b11 | b10 | b9 | b8 | |
| 03h | r | TWCH | latxf | latxf | latxf | latxf | b11 | b10 | b9 | b8 | |
| 04h | w | TACL | a7 | a6 | a5 | a4 | a3 | a2 | a1 | a0 | |
| 05h | w | TACH | a15 | a14 | a13 | a12 | a11 | a10 | a9 | a8 | |
| 06h | w | THTRG | data unused | | | | | | | | |
| 07h | w | TACK | data unused | | | | | | | | |
| 04h | r | HEAD0 | header minutes (bcd) | | | | | | | | |
| 05h | r | HEAD1 | header second (bcd) | | | | | | | | |
| 06h | r | HEAD2 | header frames (bcd) | | | | | | | | |
| 07h | r | HEAD3 | header mode (bcd) | | | | | | | | |
| 08h | w | BIAL | a7 | a6 | a5 | a4 | a3 | a2 | a1 | a0 | |
| 09h | w | BIAH | a15 | a14 | a13 | a12 | a11 | a10 | a9 | a8 | |
| 08h | r | EIAL | a7 | a6 | a5 | a4 | a3 | a2 | a1 | a0 | |
| 09h | r | EIAH | a15 | a14 | a13 | a12 | a11 | a10 | a9 | a8 | |
| 0Ah | w | CTRL0 | decen | rtedc | edcen | acen | x | bufen | qcen | pcen | |
| 0Bh | w | CTRL1 | sien | sden | dscren | cwen | m2rq | f2rq | mcrq | shden | |
| 0Ah | r | BACL | a7 | a6 | a5 | a4 | a3 | a2 | a1 | a0 | |
| 0Bh | r | BACH | a15 | a14 | a13 | a12 | a11 | a10 | a9 | a8 | |
| 0Ch | w | EIAL | a7 | a6 | a5 | a4 | a3 | a2 | a1 | a0 | |
| 0Dh | w | EIAH | a15 | a14 | a13 | a12 | a11 | a10 | a9 | a8 | |
| 0Ch | r | STAT0 | crcok | ilsyn | nosyn | lbfk | wshort | sbkf | 0 | uceblk | |
| 0Dh | r | STAT1 | bi2 | bi1 | bi0 | hdera | 0 | 0 | 0 | shdera | |
| 0Eh | w | DHTACK | data unused | | | | | | | | |
| 0Eh | r | STAT2 | rmod3 | rmod2 | rmod1 | rmod0 | mode2 | nocor | rfera | rform | |
| 0Fh | w | FRST | data unused | | | | | | | | |
| 0Fh | r | STAT3 | stavab | 0 | ecf | 0 | 0 | 0 | c2df | 0 | |
| 10h | w | CTRLW | 0 | swen | sdss | dcken | 0 | c2wen | drst | 0 | |
| 11h | w | CRTRG | data unused | | | | | | | | crrl |
| 12h | w | MBTC0 | 0 | 0 | 0 | mbc4 | mbc3 | mbc2 | mbc1 | mbc0 | |
| 12h | r | MBTC0 | mbvab | mbinc | 0 | mbc4 | mbc3 | mbc2 | mbc1 | mbc0 | |
| 13h | r/w | MBTC1 | 0 | 0 | 0 | 0 | 0 | mbtien | mbtfen | incmbc | |
| 14h | w | ECTRL | 0 | 0 | 0 | 0 | 0 | 0 | ir7f | disai | |
| 14h | r | SUBHO | subheader(file) | | | | | | | | |
| 15h | r | SUBH1 | subheader(channel) | | | | | | | | |
| 16h | r | SUBH2 | subheader(submode) | | | | | | | | |
| 17h | r | SUBH3 | subheader(coding) | | | | | | | | |



| | | | | | | | | | | | |
|-----|-----|---------|-------------|---------|--------|---------|---------|---------|---------|--------|----|
| 17h | w | ASTRG | 0 | csrt | dsct | sigt | cpft | adtt | drqt | sct | |
| 18h | r/w | ASCTRL | apkten | adcen | ascen | autoen | stwcen | aucrcen | abyen | pktien | |
| 19h | w | CCTL0 | ckstp | x | jpss | 0 | csk3 | csk2 | cks1 | csk0 | |
| 1Ah | w | CCTL1 | clkoen | tsync | xininv | psken | clk1 | clk0 | 0 | xtald2 | |
| 1Ah | r | VER | E6h | | | | | | | | |
| 1Bh | w | DPSL | c2ml | s16o | lchp | sft8 | 0 | sel16 | dir | edge | |
| 1Bh | r | C2BEB | b7 | b6 | b5 | b4 | b3 | b2 | b1 | b0 | |
| 1Ch | w | RACL | a7 | a6 | a5 | a4 | a3 | a2 | a1 | a0 | |
| 1Dh | w | RACH | a15 | a14 | a13 | a12 | a11 | a10 | a9 | a8 | |
| 2Dh | w | RACU | 0 | 0 | 0 | 0 | a19 | a18 | a17 | a16 | |
| 1Eh | w | RAMWR | b7 | b6 | b5 | b4 | b3 | b2 | b1 | b0 | |
| 1Eh | r | RAMRD | b7 | b6 | b5 | b4 | b3 | b2 | b1 | b0 | |
| 1Fh | w | HICTL0 | x | x | x | laen | mdma | pio | dinb | udma | |
| 1Fh | r | STAT5 | utby | 0 | 0 | 0 | mdma | pio | dinb | udma | |
| 20h | r/w | HICTL1 | 0 | pdiagen | daspen | clrsby | setbsy | scod | rdyen | io16en | |
| 21h | w | SICTL0 | 0 | 0 | 0 | 0 | pqenb | subcs2 | subcs1 | subcs0 | |
| 22h | w | SCIACK | data unused | | | | | | | | |
| 22h | r | SUBSTA | x | x | x | qcrcook | x | mss | nesbk | iss | |
| 24h | r/w | TBL | b7 | b6 | b5 | b4 | b3 | b2 | b1 | b0 | |
| 25h | r/w | TBH | data unused | | | | | | | | b8 |
| 26h | r/w | SCBL | b7 | b6 | b5 | b4 | b3 | b2 | b1 | b0 | |
| 27h | r/w | SCBH | data unused | | | | | | | | b8 |
| 28h | r/w | DDBL | b7 | b6 | b5 | b4 | b3 | b2 | b1 | b0 | |
| 29h | r/w | DDBH | data unused | | | | | | | | b0 |
| 2Ah | w | RAMCF | rftyp | rftrg | x | swap | b3 | rtc2 | rtc1 | rtc0 | |
| 2Ah | r | RAMCF | rftyp | rftrg | rfc | swap | b3 | rtc2 | rtc1 | rtc0 | |
| 2Bh | w | MEMCF | slts1 | dlts0 | dbaf1 | dbaf0 | dfrst | frdy | rlc1 | rlc0 | |
| 2Ch | w | SICTL1 | sbxck | scen | cd2sc | scien | exinv | exop | scf1 | scf0 | |
| 2Eh | w | MISC0 | hien | 0 | drveb | mdrv | hirq | 0 | 0 | 0 | |
| 2Eh | r | MISS0 | 1 | 1 | sруб | mdrvf | hintf | 1 | pdiagb | daspb | |
| 2Fh | w | MISC1 | arrc | sarrc | hrsts1 | hrsts0 | arsts1 | arsts0 | arstien | arwc | |
| 2Fh | r | MISS1 | srst | atac | diag | shdc | arst | rst | frst | hrst | |
| 30h | w | ARSTACK | data unused | | | | | | | | |
| 30h | r | MISS2 | srstd | cmdc | tdir | mbti | ucrcokb | crst | fpkt | apkt | |
| 31h | w | ATERR | b7 | b6 | b5 | b4 | mcr | abrt | eom | ili | |
| 31h | r | ATFEA | 0 | 0 | 0 | 0 | 0 | 0 | 0 | dma | |
| 32h | r/w | ATINT | 0 | 0 | 0 | 0 | 0 | 0 | io | cod | |
| 33h | r/w | ATSPA | 0 | 0 | 0 | 0 | 0 | 0 | 0 | 1 | |
| 34h | r/w | ATBLO | b7 | b6 | b5 | b4 | b3 | b2 | b1 | b0 | |
| 35h | r/w | ATBHI | b7 | b6 | b5 | b4 | b3 | b2 | b1 | b0 | |
| 36h | r/w | ATDRS | 1 | l | 1 | drv | 0 | 0 | 0 | 0 | |
| 37h | w | ATSTA | 0 | drdy | 0 | dsc | drq | corr | 0 | check | |
| 37h | r | ATCMD | b7 | b6 | b5 | b4 | b3 | b2 | b1 | b0 | |
| 38h | w | ASERR | 0 | 0 | 0 | 0 | 0 | 0 | 0 | scheck | |
| 38h | r | ATERR | bsy | drdy | b5 | dsc | drq | corr | 0 | check | |



| | | | | | | | | | | | |
|-----|-----|---------|------------------------------|---------|---------|---------|---------|---------|---------|---------|----|
| 39h | w | ASERR | 0 | 0 | 0 | 0 | 0 | sabrt | 0 | 0 | |
| 39h | r | ATERR | b7 | b6 | b5 | b4 | mcr | abrt | eom | ili | |
| 3Ah | r | LDDBL | latched DDBL | | | | | | | | |
| 3Bh | r | LDDBH | latched DDBH | | | | | | | | |
| 3Dh | w | APKSTA | 0 | 0 | 0 | adsc | 0 | 0 | 0 | 0 | |
| 3Eh | w | ASCSTA | 0 | adrdy | 0 | 0 | 0 | acorr | 0 | acheck | |
| 3Fh | r/w | SHDCTL | 0 | shdrv | shdrv1 | 0 | 0 | dasps2 | dasps1 | dasps3 | |
| 48h | r | LSTA0 | crck | ilsyn | nosyn | lbf | wshort | sbkf | 0 | uceblk | |
| 49h | r | LSTA1 | 0 | 0 | 0 | hdera | 0 | 0 | 0 | shdera | |
| 4Ah | r | LSTA2 | rmod3 | rmod2 | rmod1 | rmod0 | mode2 | nocor | rfera | rform | |
| 4Bh | r | LSTA3 | 0 | 0 | ecf | 0 | 0 | 0 | c2df | 0 | |
| 4Ch | r | LHD0 | latched header minutes (bcd) | | | | | | | | |
| 4Dh | r | LHD1 | latched header second (bcd) | | | | | | | | |
| 4Eh | r | LHD2 | latched header frames (bcd) | | | | | | | | |
| 4Fh | r | LHD3 | latched header mode (bcd) | | | | | | | | |
| 50h | r/w | DTRBL | b7 | b6 | b5 | b4 | b3 | b2 | b1 | b0 | |
| 51h | r/w | DTRBH | data unused | | | | | | | | b8 |
| 52h | r/w | DTRCL | b7 | b6 | b5 | b4 | b3 | b2 | b1 | b0 | |
| 53h | r/w | DTRCH | data unused | | | | | | | | b8 |
| 54h | r/w | WBRBL | b7 | b6 | b5 | b4 | b3 | b2 | b1 | b0 | |
| 55h | r/w | WBRBH | data unused | | | | | | | | b8 |
| 56h | r/w | WBRCL | b7 | b6 | b5 | b4 | b3 | b2 | b1 | b0 | |
| 57h | r/w | WBRCH | data unused | | | | | | | | b8 |
| 58h | r/w | | reserved | | | | | | | | |
| 59h | r | PSKSTA | locked | onlock | psk5 | psk4 | psk3 | psk2 | psk1 | psk0 | |
| 59h | w | PSKCTL | psksel | locksel | psk5 | psk4 | psk3 | psk2 | psk1 | psk0 | |
| 5Ah | w | SCTC | d7 | d6 | d5 | d4 | d3 | d2 | d1 | d0 | |
| 5bh | r/w | ENCTL1 | asdma | asrit | dsp1stb | b4 | alrt | b2 | dra | b0 | |
| 5ch | r/w | ENCTL2 | x | x | x | x | ale2 | synp | b1 | rmsri | |
| 5dh | r | LSUBH2 | latched submode number | | | | | | | | |
| 5eh | r | PSKCNT | x | x | x | pskcnt4 | pskcnt3 | pskcnt2 | pskcnt1 | pskcnt0 | |
| 5fh | r/w | GIOCTL | x | x | g2oen | g1oen | x | gin3 | gio2 | gio1 | |
| 80h | w | TARCTL | targen | dscen | qen | qmsf | astopb | ltten | tnfen | hceen | |
| 80h | r | TARSTA | targed | staerr | bin0 | dsfuli | lastbk | ltti | tnfi | hcei | |
| 81h | w | DSTL | b7 | b6 | b5 | b4 | b3 | b2 | b1 | b0 | |
| 81h | r | DSCL | b7 | b6 | b5 | b4 | b3 | b2 | b1 | b0 | |
| 83h | w | TSL | b7 | b6 | b5 | b4 | b3 | b2 | b1 | b0 | |
| 83h | r | TSC | b7 | b6 | b5 | b4 | b3 | b2 | b1 | b0 | |
| 84h | r/w | TARGET0 | target minute (bcd) | | | | | | | | |
| 85h | r/w | TARGET1 | target second (bcd) | | | | | | | | |
| 86h | r/w | TARGET2 | target fram (bcd) | | | | | | | | |
| 87h | r/w | DACTL | da0en | ctlsel | acu1 | acu0 | qct3 | qct2 | qct1 | qct0 | |
| 88h | r/w | FEACTL | lecas | lref | mrcd | sdb5 | sbck | cas8b | frcdb | edoen | |
| 89h | r/w | DFFCNTL | 1 | 1 | ffht2 | dffht1 | dffht0 | dfflt2 | dfflt1 | dfflt0 | |
| 8ah | r/w | ATCTL | xoff | x | udt1 | udt0 | uclks | reft1 | reft1 | reft0 | |

W88113C



| | | | | | | | | | | |
|-----|-----|--------|-------------|--------|----------|--------|---------|--------|--------|---------|
| 8ch | w | STA0M | crcokm | ilsynm | nosynm | lblkm | wshortm | sblkm | bin0m | uceblkm |
| 8dh | w | STA1M | 0 | 0 | 0 | hderam | 0 | 0 | 0 | shderam |
| 8eh | w | STA2M | 0 | 0 | 0 | 0 | 0 | nocorm | rferam | 0 |
| 8fh | w | STA3M | 0 | 0 | cblkm | 0 | 0 | 0 | c2blkm | 0 |
| 90h | r/w | APCNF | apen | apien | apdirect | apins | apin1 | apin0 | apout1 | apout0 |
| 91h | r/w | APFMT | apfmt7 | apfm6 | apfmt5 | apfmt4 | apfmt3 | apfmt2 | aptm1 | apfmt0 |
| 92h | r/w | APBKL | b7 | b6 | b5 | b4 | b3 | b2 | b1 | b0 |
| 93h | r/w | APBKH | aptest | aptest | 0 | 0 | 0 | 0 | 0 | b8 |
| 94h | r/w | APWCL | 97h | | | | | | | |
| 95h | r/w | APWCH | 04h | | | | | | | |
| 96h | r/w | APVOL | lvol3 | lvol2 | lvol1 | lvol0 | rvol3 | rvol2 | rvol1 | rvol0 |
| 97h | w | APACK | data unused | | | | | | | |
| 98h | w | PUCTL | hip1 | hip0 | uip1 | uip0 | rip1 | rip0 | hd7upb | apipb |
| 99h | w | SICTL | hic1 | hic0 | uic1 | uic0 | ric1 | ric0 | x | apic |
| 9ah | r/w | BICCTL | bicen | atmsen | blimen | blims | rclim3 | rclim2 | rclim1 | rclim0 |
| 9bh | w | BUFLIM | b7 | b6 | b5 | b4 | b3 | b2 | b1 | b0 |
| 9bh | r | BUFC | b7 | b6 | b5 | b4 | b3 | b2 | b1 | b0 |
| 9ch | r/w | ACCTL | atten | acmen | tcincen | atlim4 | atlim3 | atlim2 | atlim1 | atlim0 |
| 9dh | r/w | TCC | b7 | b6 | b5 | b4 | b3 | b2 | b1 | b0 |
| 9eh | r/w | SKIPC | b7 | b6 | b5 | b4 | b3 | b2 | b1 | b0 |
| 9fh | r/w | TTC | b7 | b6 | b5 | b4 | b3 | b2 | b1 | b0 |



4. CHARACTERISTICS

($T_A = 0^\circ\text{C TO } 70^\circ\text{C}$, $V_{DD} = 5V \pm 5\%$, $V_{SS} = 0V$)

| SYM | PARAMETER | MIN | MAX | UNIT | CONDITION |
|-----------|------------------------|---------------------|---------------------|---------------|---|
| V_{OH} | Output HIGH Voltage | 2.4 | | V | $I_{OH}=400\mu\text{A}$ |
| V_{OL} | Output LOW Voltage | | 0.4 | V | $I_{OL}=6$ or 12mA (Note 1) |
| V_{IH1} | Input HIGH Voltage | $0.7 \times V_{DD}$ | $V_{DD}+0.5$ | V | UD[7:0], DD[15:0], RD[15:0], DASPb, PDIAGb, EXCK |
| V_{IL1} | Input LOW Voltage | -0.5 | $0.3 \times V_{DD}$ | V | |
| V_{IH2} | Input HIGH Voltage | 2 | $V_{DD}+0.5$ | V | LRCK, SDATA, BCK, C2PO, SCSD, WFCK, SCSYN, HRSTb, URS, URDb, UWRb, UCSb, CS3b, CS1b, DA[2:0], DMACKb, HRDb, HWRb, CRSTb |
| V_{IL2} | Input LOW Voltage | -0.5 | 0.8 | V | |
| I_{L11} | Input Leakage Current | -10 | 10 | μA | |
| I_{L12} | Input Leakage Current | -130 | -400 | μA | Pins with Pullup Resistor at PAD = 0V (Notes 3) |
| I_{LO1} | Output Leakage Current | -10 | 10 | μA | |
| I_{LO2} | Output Leakage Current | -130 | -400 | μA | Pins with Pullup Resistor at PAD = 0V (Notes 3) |

Notes:

1. Output current (IOL) Capabilities:

6mA: RAS, CASH, CASL, RA[8:0], RWEb, ROEb, CLKO, UD[7:0], RD[15:0], PDIAGb, ABCK, ADAT, ARSTb, HRSTb

16mA: DD[15:0], DASPb, HIRQ, DMARQ, UINTb, EXCK, IORDY, IOCS16b

2. The chip contains internal resistance between XIN and XOUT

3. The chip contains internal pullup resistance between VDD and the following pins:

Input: HA[2:0], DMACKb, HRDb, HWRb, CS1b, CS3b

Output: ROEb, UINTb

Bi-directional: DD[15:0], RD[15:0], UD[7:0], DASPb, PDIAGb, EXCK, HRSTb, ARSTb



5. APPLICATION NOTES

5.1 DRAM Interface

5.1.1 Memory Layout

The whole DRAM can be divided into Sector *Data Area* and *Working Area*. Sectors from DSP are buffered into Sector Data Area and then are retrieved for ECC/EDC operation. Some information is stored in working area for transfer to host on request, for example, TOC.

Sector data buffering is a block-based ring operation. If the decoded-block-number in *DDBH/L* (29h/28h) is $N - 1$, the sector is buffered into block with number N . The decoded-block-number is automatically incremented by one at each sync. When the decoded-block-number equals the value in *WBRCH/L* (57h/56h), the sector is buffered into the block with number specified by *WBRBH/L* (55h/54h).

The data transfer is also a block-based ring operation if multi-block-transfer is used. The transfer ring is controlled by *DTRCH/L* (53h/52h) and *DTRBH/L* (51h/50h). The buffer ring and transfer ring are usually defined in the same range.

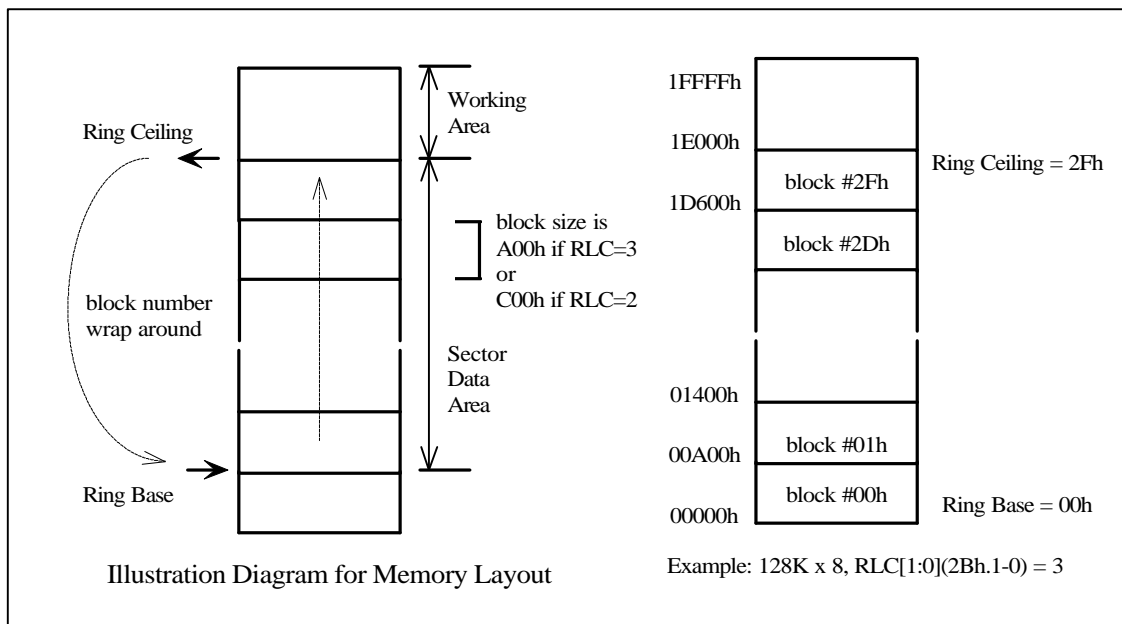



5.1.2 Block Configuration

The configuration of each memory block depends on the data format. The following figures show the recommended configuration of block whose size is A00h and C00h, respectfully.

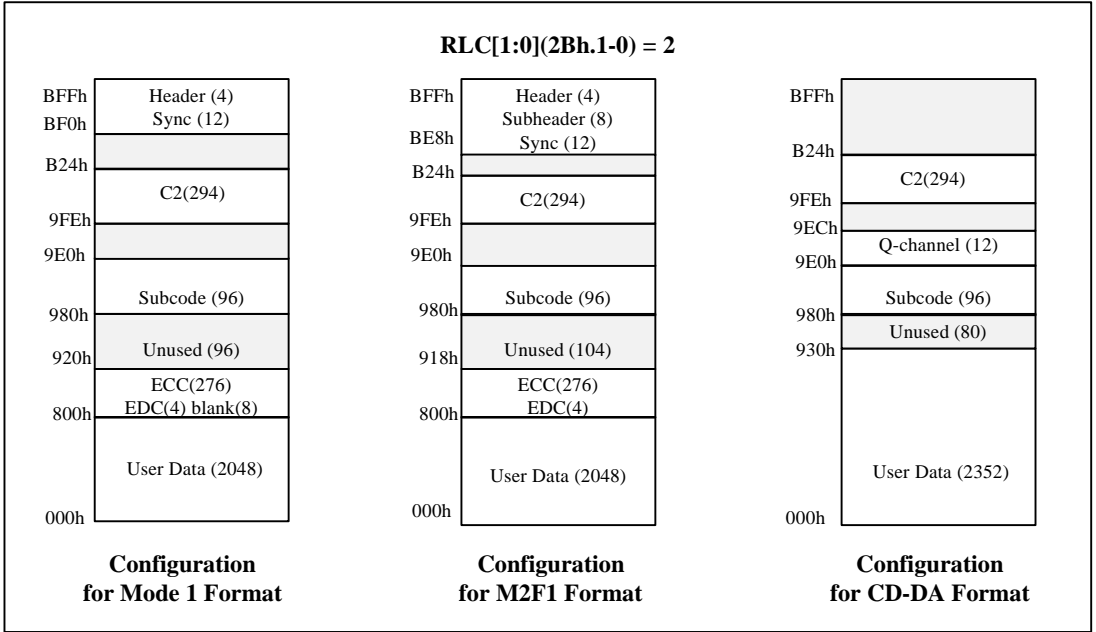
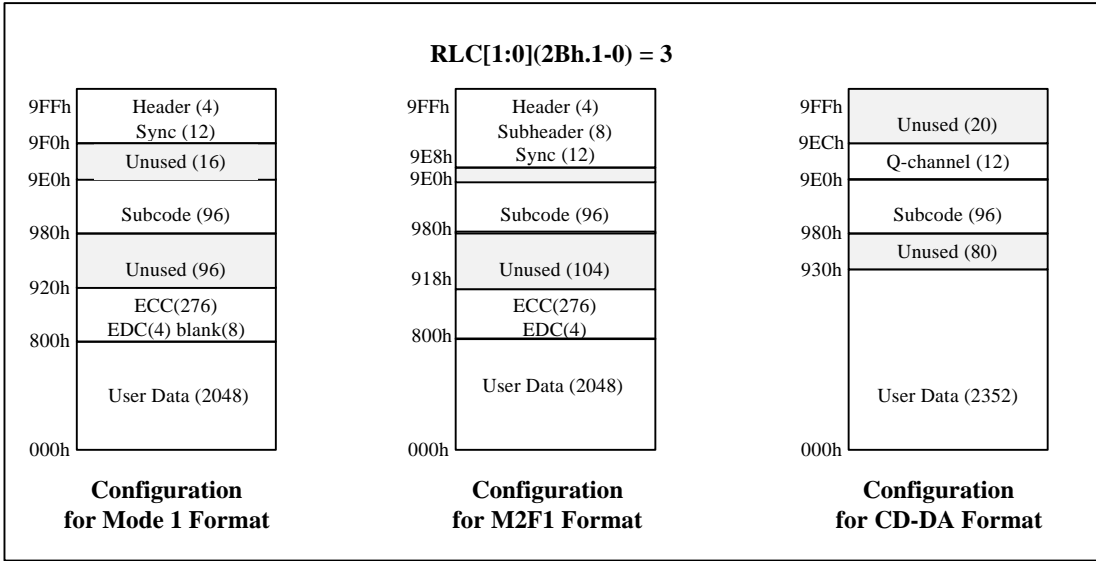



The rule for configuration is that the first byte of the sector is stored at:

$$BIAH/L(09h/08h, w) - 0Ch$$

And the following byte is stored into the incremented offset address. If the offset address reaches the block limit, the next offset address is wrap around to zero. For example, the byte following that at offset 9FFh is at 000h if block limit is A00h. By this mechanism and following example settings, the first byte of user data is always located at 000h.

The C2 flag (9FEh), Subcode (980h) and Q-channel (9E0h) data are stored at fixed address if its associated function is enabled. But the 2352 bytes sector data (including sync, header, user data, ECC, EDC for Mode 1 sector) can be re-arranged to any other area in the block.

Buffering & Decoding Setting example

The block for buffering and decoding function is set by DDBH/L (29h/28h).

| | CD-DA | yellow book mode 1 & mode 2 | CD-ROM XA mode 2 |
|------------------------|-------|--------------------------------|---------------------|
| BIAH/L(08h/09h) | 000Ch | FFFCh | FFF4h |
| first sync | n/a | FFF0h | FFE8h |
| first header | n/a | FFFCh | FFF4h |
| first subheader | n/a | n/a | FFF8h |
| first data | 0000h | 0000h | 0000h |

Data Transfer Setting example

The block for data transfer function is set by TBH/L (25h/24h).

| | Mode 1 | | Mode 2 | | CD-DA |
|------------------------|--------|-------|--------|-------|-------|
| Transfer Bytes | 2048 | 2352 | 2048 | 2352 | 2352 |
| TACH/L(05h/04h) | 0000h | FFF0h | 0000h | FFE8h | 0000h |
| TWCH/L(03h/02h) | 03FFh | 0497h | 03FFh | 0497h | 0497h |



5.1.3 Linear Address v.s. Block-Offset Address

The microprocessor can write/read external RAM through register *RAWR/RAMRD (1Eh)* based on linear address defined by *RACU/H/L (2Dh/1Dh/1Ch,w)*. But the operation of data transfer from DRAM to host can base on block-offset address or linear address. The following equation defines the relation between these two types of address.

$$\text{linear address} = (\text{block number} \cdot \text{block size}) + \text{address offset}$$

<Example 1> Data Transfer in Working Area

Conditions: 64 bytes of TOC data are stored starting from linear address 3EA00h at disc initialization and TOC is requested by host (block size is A00h).

A) Sequence at disc initialization:

- a) set RACL (1Ch) as 00h
- b) set RACH (1Dh) as EAh
- c) set RACU (2Dh) as 03h
- d) wait UTBY (1Fh.7) low
- e) write data to register RAMWR (1Eh)
- f) goto step e) until all 64 bytes are written to DRAM

B1) Setting for *block-offset address* transfer:

- set TBH/L (25h/24h) as 0064h
- set TACH/L (05h/04h) as 0200h
- set TWCH/L (03h/02h) as 001Fh

B2) Setting for *linear address* transfer:

- set RACL (1Ch) as 00h
- set RACH (1Dh) as EAh
- set RACU (2Dh) as 03h
- set TWCH/L (03h/02h) as 801Fh

<Example 2> Data Transfer in User Area

Conditions:

- Mode 1 data.
- The block number read from register DDBH/L (29h/28h) is 1Fh.

Case 1: The 2048 bytes of user data are requested by host.

- set TBH/L (25h/24h) as 001Fh
- set TWCH/L (03h/02h) as 03FFh
- set TACH/L (05h/04h) as 0000h

Case 2: The 288 bytes of EDC&ECC data are request by host.

- set TBH/L (25h/24h) as 001Fh



- set TWCH/L (03h/02h) as 008Fh
- set TACH/L (05h/04h) as 0800h

Case 3: The 2352 bytes of sync, header, user data and EDC&ECC are request by host.

- set TBH/L (25h/24h) as 001Fh
- set TWCH/L (03h/02h) as 0497h
- set TACH/L (05h/04h) as FFF0h

If the requested data is not stored continuously in DRAM, e.g., header and EDC&ECC data, more than one transfer has to be triggered.

5.1.4 16-bit DRAM

High DRAM bandwidth is the key issue to support high disk speed and can be dramatically by using 16-bit DRAM.

The following setting should be made at initialization to utilize 16-bit DRAM.

- The control bit *ALE2* (5Ch.3) should be set high (default after chip reset).
- The value of *RTC2-0* (2Ah.2-0,w) should be **101b** (9 col) or **100b** (8 col).
- The *Ring Control Registers* (50h-57h) should also be set to fully utilize the DRAM space.

Since DRAM access is based on linear addressing, there is no need of further firmware change.

5.1.5 EDO DRAM

EDO DRAM is designed to improve the DRAM read performance. The EDO DRAM support is enabled by setting control bit *EDOEN* (88h.w0) high. When this bit is set high, the data latch timing of DRAM changes to falling edge instead of rising edge of internal clock.

The timing of DRAM is controlled by *MRCD* (88h.w5) and *FRCDB* (88h.w1). The slower timing may be required to support some slower DRAMs.

| MRCD | FRCDB | tRCD | tRP | tPC | Minimum Cycle |
|------|-------|-------|-------|-----|---------------|
| 0 | 0 | 1 T | 1.5 T | 1 T | 3 T |
| 0 | 1 | 2 T | 1.5 T | 1 T | 4 T |
| 1 | 0 | 1.5 T | 1 T | 1 T | 3 T |
| 1 | 1 | x | x | x | x |

Note: T is the system clock period.

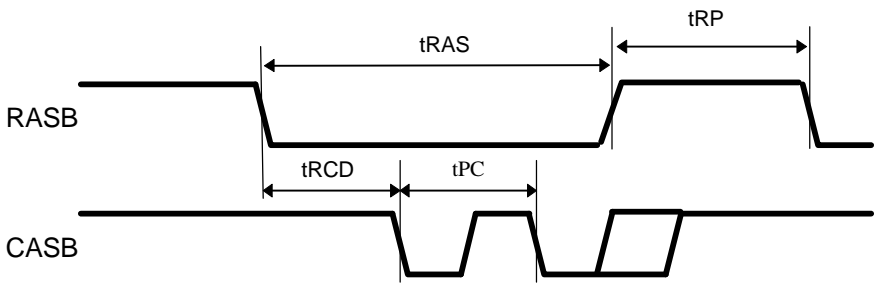

DRAM Timing

5.2 Microcontroller Interface

5.2.1 Direct Register Addressing

The default register addressing mode of W88113CF is direct register addressing mode. If ALE2 (5Ch.3) is low, pin RD12/ALE1 (5) is used as ALE input; otherwise, pin ALE2 (64) is used as ALE input (default after chip reset).

| Alternative Power-On Setting | | | | |
|------------------------------|------------------------|---------------------------|---------------|------------------------|
| RA8 pull-down 4.7KΩ | RA7 pull-down 4.7KΩ | Direct Register Select | ALE input pin | 16-bit DRAM support |
| no (default) | no (default) | yes | ALE2 | yes |
| no | yes | yes | ALE1 | no |
| yes | no | no | x | yes |
| yes | yes | no | x | no |

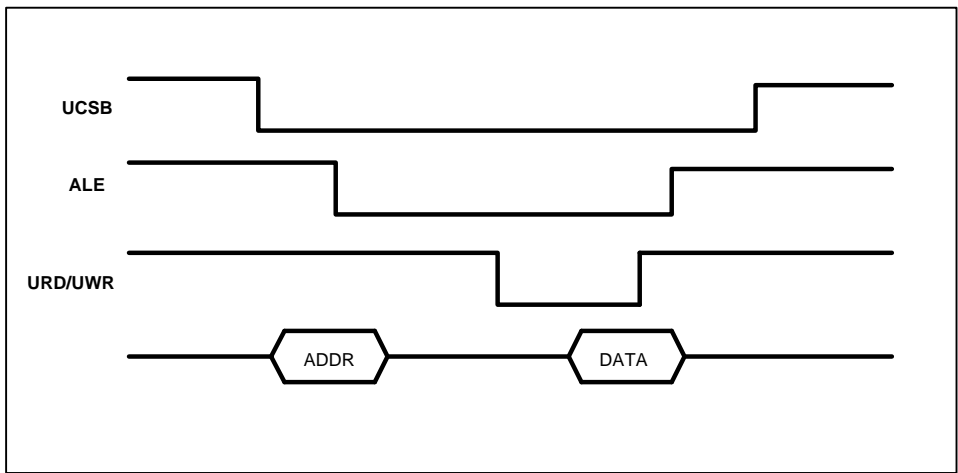



5.2.2 General I/O

Pin *HRSTb* (21) and pin *ARSTb* (60) can be configured as general I/O pins through register *MISC1* (2Fh.w). The state of these two general I/O pins can be controlled through register *GIOCTL* (5Fh). The pin state of *URS* (32) can be read back from *GIN3* (5Fh.r2) if *DRA* (5Bh.1) is high and *DA0EN* (87h.7) is low.

5.2.3 Programmable System Clock

The internal system frequency is controlled by *CCTL1* (1Ah.w) and *PSKCTL* (59h.w). Register *PSKCTL* (59h.w) should be set before the programmable system clock is enabled by setting *PSKEN* (1Ah.w4) high. If both *PSKEN* (1Ah.w4) and *PSKSEL* (59h.w7) are high, *PSK5-0* (59h.5-0) are used to controlled the internal system frequency. Register *PSKCTL* (59h.w) should be set before the programmable system clock is enabled by setting *PSKEN* (1Ah.w4) high. The equation is:

$$\text{frequency system clock} = \text{frequency of XIN} \cdot (\text{PSK}[5:0] + 2) \cdot 16$$

The variation of the resultant system frequency is normally less than 5%.

<example> If the frequency of pin XIN (15) is 33.8688 MHz, *PSKEN* (1Ah.w4) and *PSKSEL* (59h.w7) are high:

| PSK5-0 | System Frequency | |
|--------|------------------|--|
| 0Fh | 36 MHz | |
| 11h | 40.2 MHz | |
| 13h | 44.4 MHz | |
| 15h | 48.7 MHz | |
| 17h | 53 MHz | |
| 19h | 57.2 MHz | |
| 1Bh | 61.4 MHz | |

<example> If the frequency of pin XIN (15) is 24 MHz, *PSKEN* (1Ah.w4) and *PSKSEL* (59h.w7) are high:

| PSK5-0 | System Frequency | |
|--------|------------------|--|
| 14h | 33 MHz | |
| 16h | 36 MHz | |
| 18h | 39 MHz | |
| 1Ah | 42 MHz | |
| 1Ch | 45 MHz | |
| 1Eh | 48 MHz | |
| 20h | 51 MHz | |



<example> XIN=33.86MHz, PSKCTL (59h) = D3h, CCTL1 (1Ah) = 98h

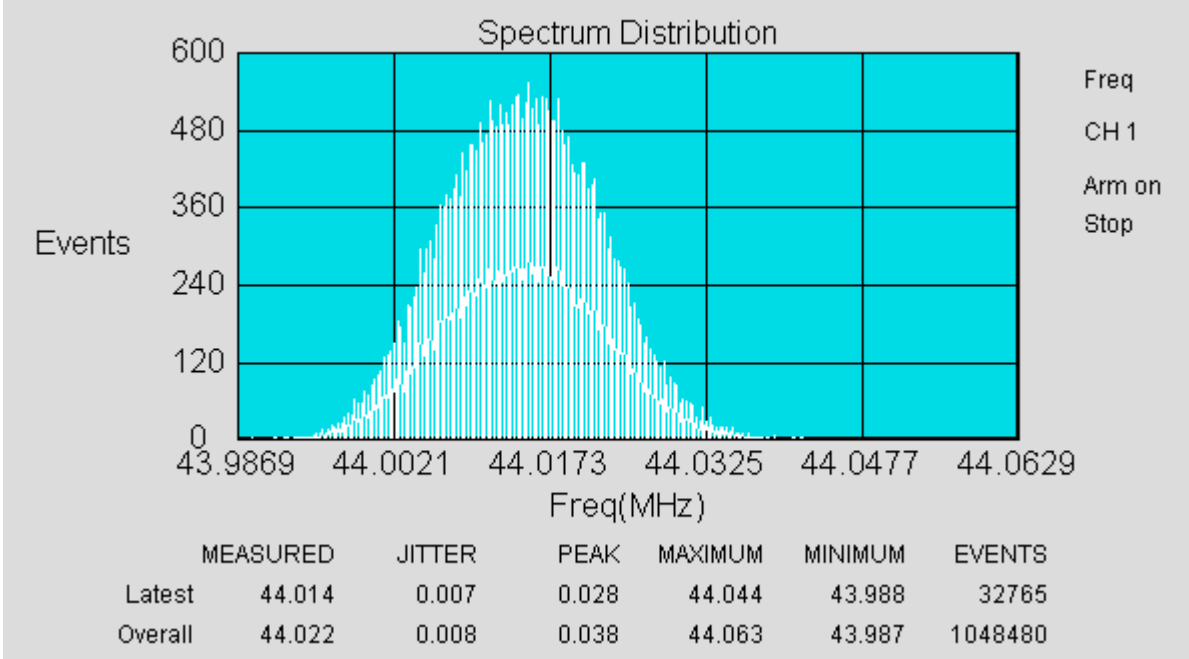

<example> XIN=33.86MHz, PSKCTL (59h) = D5h, CCTL1 (1Ah) = 98h

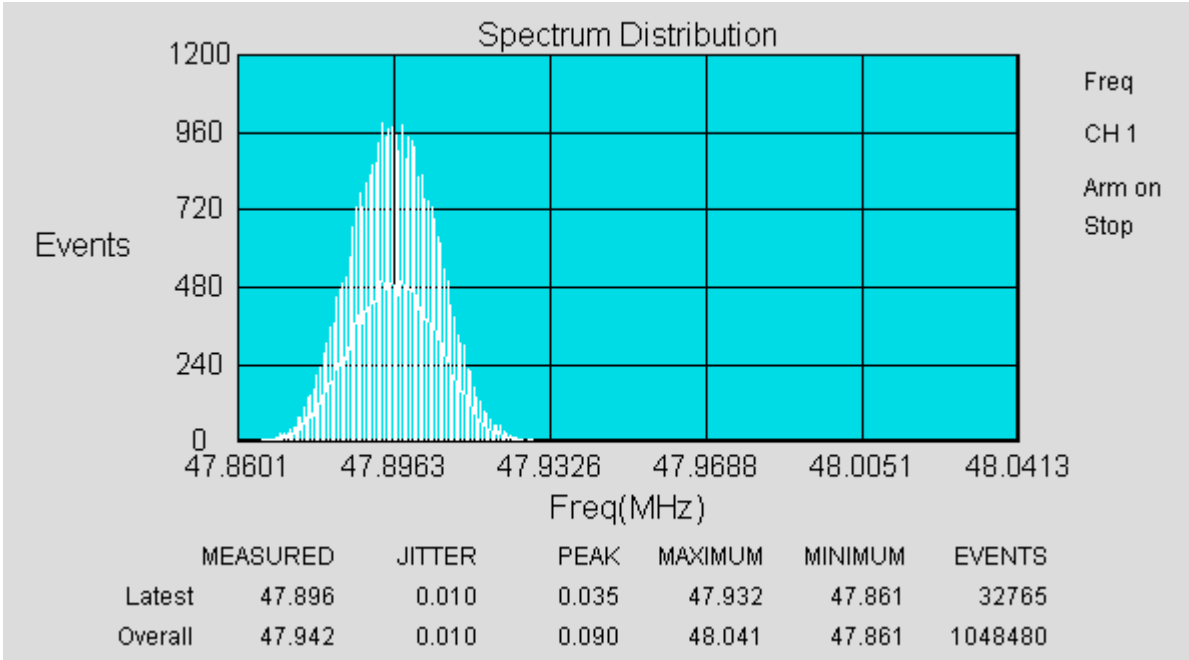



5.3 Host Interface

The host interface is a standard ATAPI interface with enhanced Ultra DMA support. The Ultra DMA protocol could double the current burst transfer rate of 16.6MB/sec to 33MB/sec without hardware changes such as termination devices or different cabling.

5.3.1 Ultra DMA Mode Setting

This decoder is capable of supporting Ultra DMA Mode 2. Device firmware could claim that *Ultra DMA mode 2 and below are supported* in IDENTIFY DEVICE information.

Once Ultra DMA is enabled, the *Ultra DMA burst* is defined as the period from an assertion of DMACKb to the subsequent negation of DMACKb. Three pins in the following table are re-defined during an Ultra DMA burst.

| Value of Register 1Fh | PIO/DMA | Ultra DMA Data-In x9h | Ultra DMA Data-out xBh |
|-----------------------|---------|-----------------------|------------------------|
| pin 49 | IORDY | DSTROBE | DDMARDYB |
| pin 50 | HRDb | HDMARDYB | HSTROBE |
| pin 52 | HWRb | STOP | STOP |

The value of *UDT1-0 (8Ah,5-4)* defines the Ultra DMA Timing Factor, **udtf**, which control the timing of Ultra DMA transfer.

$$T_{cyc} = (2 + \mathbf{udtf}) \times T_{udma}$$

Where T_{udma} is clock period that depends on *UCLKS (8Ah.3)*

and T_{cyc} is Ultra DMA cycle time (from DSTROBE edge to DSTROBE edge)

Device firmware should set **udtf** according to the clock source and the assigned Ultra DMA transfer mode after host issues SET FEATURE command. If there are frequent CRC errors in data-in bursts, device firmware may switch system to slower Ultra DMA mode by increasing **udtf** to improve data integrity.

Example: If *UCLKS (8Ah.w3)* is low and system clock is 33.8688MHz, the **udtf** should be the following value to abide by the determined Ultra DMA mode.

| Ultra DMA | Tcyc Min. Spec. | Tcyc | udtf |
|-----------|-----------------|---------|-------------|
| Mode 0 | 114 ns | 118 ns | 2 |
| Mode 1 | 75 ns | 88.6 ns | 1 |
| Mode 2 | 55 ns | 59 ns | 0 |

5.3.2 Ultra DMA Data-out

The programming of Ultra DMA transfer is similar to that of Multi-word DMA transfer. One thing should be noted is that *device should prepare to receive one additional word at the end of a data out burst*. Since 12-byte Packet FIFOs are used to receive data in Ultra DMA data-out transfer, the value



of registers *TWCH/L* (03h/02h) should be set 4 instead of 5. Then firmware should repeatedly read register *PFAR* (00h,r) after Transfer End Interrupt asserts until flag *PFNEb* (01h.r7) becomes one.

<example> data-out transfer sequence:

1. *TENDEN* (01h.w6) ← 1
2. *ASCTRL* (18h,w) ← 58h
3. *HICTL0* (1Fh.w) ← 0Bh // UDMA data-out
4. *TWC* (03h/02h,w) ← min(0004h, byte_cnt/2-1)
5. *ADTT* (17h.w2) ← 1 // automatic data transfer trigger
6. wait *TENDb* (01h.r6) = 0 and *TDIR* (30h.r5) = 1 and *FPKT* (30h.r1) = 1
7. *TACK* (07h,w) ← FFh
8. read *PFAR* (00h,r); byte_cnt = byte_cnt - 1
9. if *PFNEb* (01h.r7) is low, repeat step (8)
10. if (byte_cnt ≠ 0) goto step (4)
11. *SCT* (17h.0) ← 1 // status complete trigger

5.3.3 Ultra DMA Error Handling

Flag *UCRCOKb* (30h.r3) is used to determine if a CRC error event has occurred during latest Ultra DMA burst. If *AUCRCEN* (18h.2) and *ASCEN* (18h.5) are both set high, the automatic status complete logic would not be triggered if *UCRCOKb* (30h.r3) is high. Therefore, firmware should check *UCRCOKb* (30h.r3) flag after each Ultra DMA burst. If a CRC error has occurred, firmware should set *CHK* (37h.0) to one and manually trigger status complete.

5.3.4 Ultra DMA Data-In Transfer Diagram

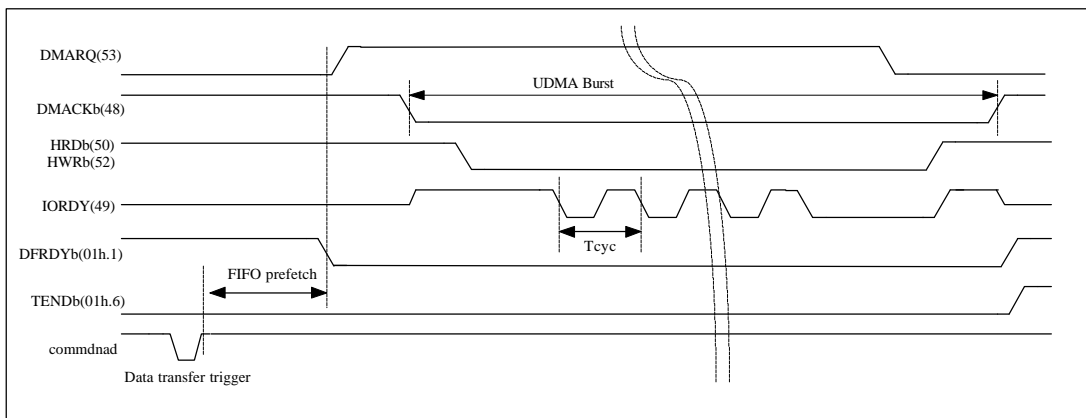



5.3.5 Data-in Transfer Flowchart Example

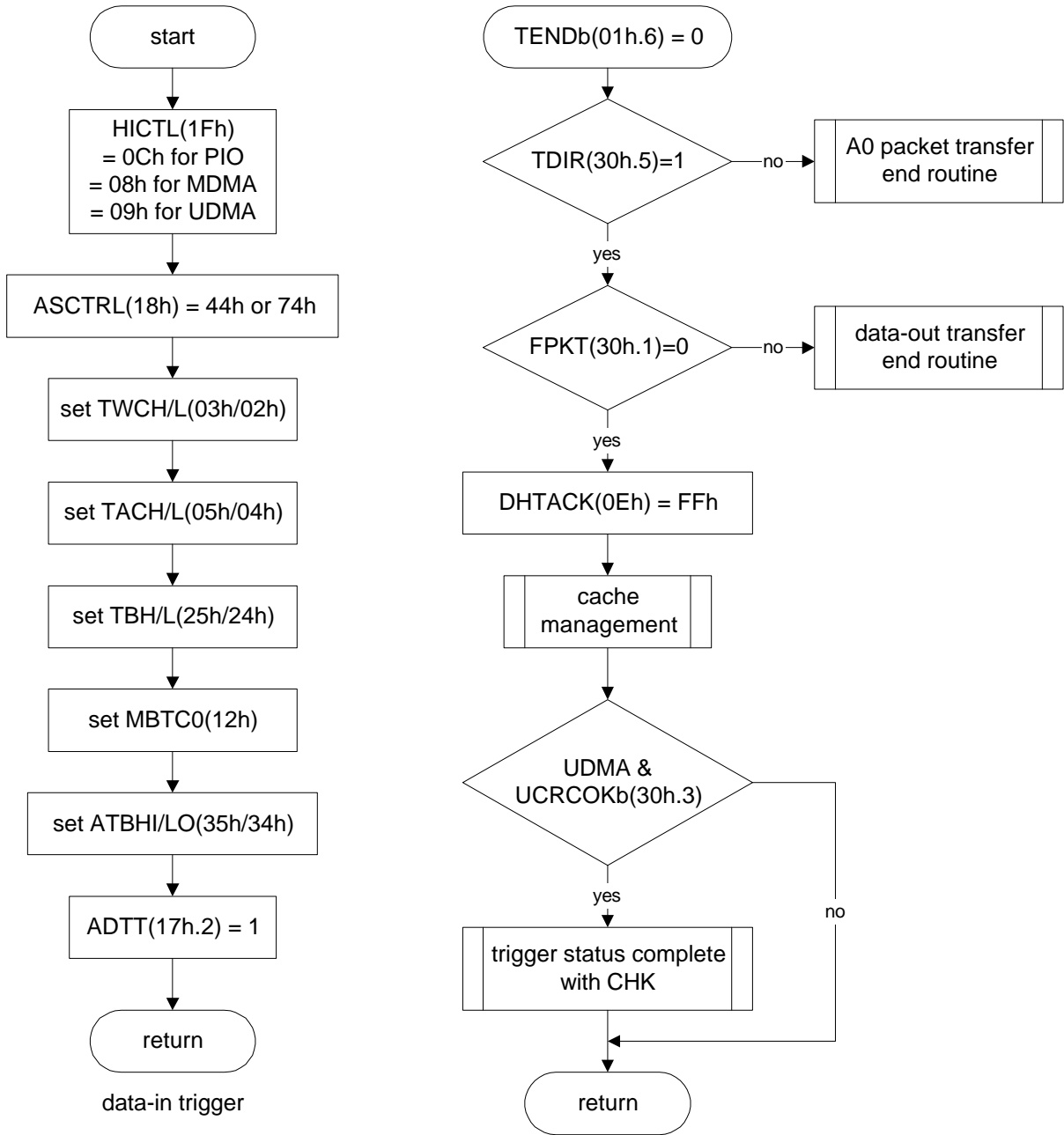



5.3.6 BSY flag control

BSY is bit-7 of ATAPI Status Register.

| BSY set | BSY clear |
|---|---|
| chip reset | Set <i>CLRBSY</i> (20h.w4) if <i>APKT</i> (30h.r0) is low |
| host reset | Set <i>DRQT</i> (17h.w1) if <i>PIO</i> (1Fh.2) is high |
| Set bit <i>SRST</i> in ATAPT Device Control Register | Host issue ATAPI Command (opcode A0h) if <i>APKTEN</i> (18h.7) is high |
| Set <i>SETBSY</i> (20h.w3) if <i>APKT</i> (30h.r0) is low | Automatic Status Completion sequence, enabled by <i>SCT</i> (17h.w0) or <i>ASCEN</i> (18h.5) |
| Host issues Execute Diagnostics Command (opcode 90h) | <i>DFRDYb</i> (01h.r1) becomes low after <i>ADTT</i> (17h.w2) is set, if <i>PIO</i> (1Fh.2) is high |
| Host issue ATA Command when drive is selected | |
| Transfer end if <i>ADCEN</i> (18h.6) is enabled | |
| Set <i>ADTT</i> (17h.w2) | |
| Set <i>DSCT</i> (17h.w5) if <i>ABYEN</i> (18h.1) is enabled - lasting 3 system clocks | |

5.3.7 Pin HIRQ control

Pin HIRQ (47) is set or clear by the following conditions if the drive is selected and *nIEN* is enabled in the ATAPI Device Control Register.

HIRQ is activated by the following:

- Automatic Packet Transfer sequence, enabled by *APKTEN* (18h.7)
- Automatic Status Completion sequence, enabled by *SCT* (17h.w0) or *ASCEN* (18h.5)
- Write *MISC0* (2Eh) with bit-3 high

HIRQ is de-activated by the following:

- Chip reset or host reset or firmware rest
- Set bit *SRST* in the ATAPI Device Control Register high
- Host issue ATA command while the drive is selected
- Host read ATAPI Status Register while the drive is selected
- Write *MISC0* (2Eh) with bit-3 low



5.4 Decoder Logic

5.4.1 Sync Detection/Insertion

The sync field of CD-ROM data is recorded as following: 1 (00h) bytes, 10 (FFh) bytes and 1 (00h) byte. This sync field is detected for sector synchronization if *SDEN (0Bh.w6)* is enabled. To prevent loss of synchronization caused by broken sync, an internal counter can provide inserted sync signal if *SIEN (0Bh.7)* is enabled. There are no sync bytes in CD-DA format, so *SDEN (0Bh.w6)* should not be set.

5.4.2 Descramble

Bytes 12 to 2351 of each CD-ROM sector is scrambled in decoding. Setting *DSCREN (0Bh.5)* high enables the descramble logic. Descramble logic should be disabled while reading of CD-DA data.

5.4.3 Disk-Monitor Mode

The decoder logic is in disk-monitor mode if *CTRL0 (0Ah.w)* is set as 80h. In disc-monitor mode, no ECC correction and EDC checking is carried. The sector ready interrupt flag *SR1b (01h.r5)* is immediately generated when the header bytes are available in *HEAD0-3 (04h-07h,r)*. The header bytes in disc-monitor mode are less trustworthy than that in buffer-correction mode.

5.4.4 Parallel ECC Correction

The error correction encoding/decoding of the CD-ROM sector is carried by a Reed-Solomon Product-Like Code (RSPC). The RSPC is a product code over $GF(2^8)$ field which is generated by the primitive polynomial

$$P(x) = x^8 + x^4 + x^3 + x^2 + 1$$

The primitive element α of $GF(2^8)$ is

$$\alpha = (00000010)$$

where the right-most bit is the least significant bit.

The data is divided into high byte plane and low byte plane before decoding. The RSPC decoding, operating on bytes, is then applied twice, once to the high byte plane, once to the low byte plane.

To improve the efficiency of RSPC decoding, a parallel ECC correction logic is implemented on chip. After sync detection and descrambling, the parallel ECC correction is carried on high byte plane and low byte plane simultaneously. This correction scheme is about 33% faster than conventional decoder.

The Q-code correction and P-code correction are enabled by *QCEN (0Ah.w1)* and *PCEN (0Ah.w0)* respectively. If both correction operations are enabled, Q-code correction is executed first. The corrected data are written back to external RAM if *CWEN (0Bh.w4)* is high.



5.4.5 EDC Checking

The EDC checking logic carry 32-bit CRC checking on error corrected data according to its mode. The checking result can be monitored through flag *CRCOK* (*0Ch.r7*). If the result is error, the errors in sector may exceed the capacity of correction logic and some data might be miscorrected.

5.4.6 Real Time EDC Checking

If real time EDC checking logic is enabled by setting *RTEDC* (*0Ah.w6*) high, the remainder of serial data is calculated while the sector is being buffered into DRAM. The sector ready interrupt flag *SRlb* (*01h.r5*) is immediately activated at next sync if the resultant remainder is zero, i.e., no EDC error. If there is error, the specified error correction is then applied to the buffered data. This function should not be enabled in disk-monitor mode.

5.4.7 Decoding Sequence Model

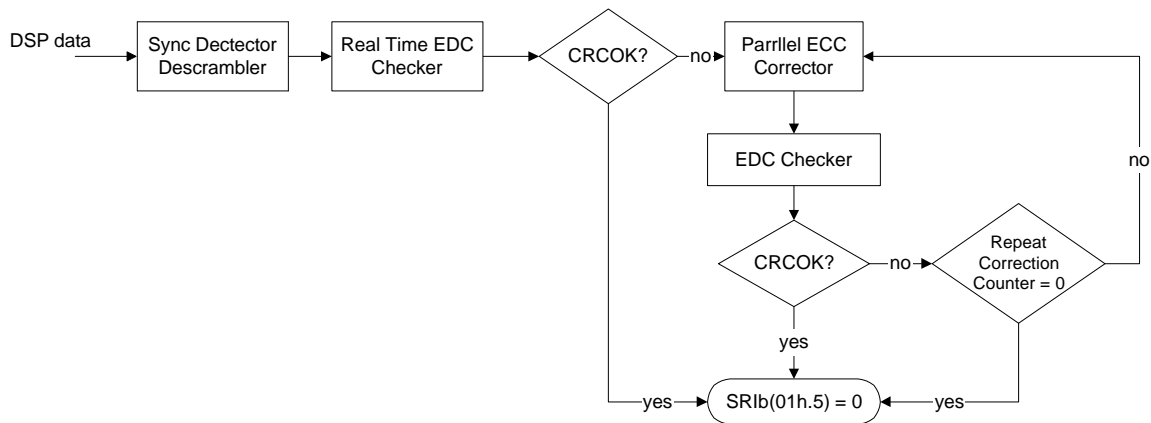

5.4.8 Disc Format Selection

Before enable decoder logic through register *CTRL0* (*0Ah.w*), appropriate value should be set to register *CTRL1* (*0Bh.w*) according to different disc format. If *ACEN* (*0Ah.w4*) and *M2RQ* (*0Bh.w3*) are both high, the type of error correction is automatically determined by *FORM* bit in the subheader byte rather than setting of *F2RQ* (*0Bh.w2*). The value of *ACEN* (*0Ah.w4*) does not affect the yellow-book mode-1 correction.

| disc format | SIEN (0Bh.7) | SDEN (0Bh.6) | DESCREN (0Bh.5) | CWEN (0Bh.4) | M2RQ (0Bh.3) | F2RQ (0Bh.2) |
|--------------------|-----------------|-----------------|--------------------|-----------------|-----------------|-----------------|
| CD-DA | 1 | 0 | 0 | 0 | 0 | 0 |
| yellow book Mode 1 | 1 | 1 | 1 | 1 | 0 | 0 |
| yellow book Mode 2 | 1 | 1 | 1 | 0 | 0 | 0 |
| CD-ROM XA M2F1 | 1 | 1 | 1 | 1 | 1 | 0 |
| CD-ROM XA M2F2 | 1 | 1 | 1 | x | 1 | 1 |

5.4.9 CD-DA data & Q-channel Extraction

There are no sync bytes in CD-DA format, so MSF bytes of Q-channel information can be utilized as synchronization when reading CD-DA data. Q-channel extraction can be enabled by setting both *QEN* (80h.w5) and *SCEN* (2Ch.w6) high. Once decoder and Q-channel extraction are both enabled, the extracted Q-channel bytes are written into the DRAM starting from offset 9E0h of each block regardless of what mode of data is set. The absolute MSF information can be retrieved from offset 9E7h, 9E8h and 9E9h of each block.

There is an alternative way to access MSF of Q-channel information. If control bit *QMSF* (80h.w4) is set high, the corresponding MSF bytes in Q-channel information would be automatically loaded into *HEAD0-2* (04h-06h,r) when each byte is ready from DSP. **Notice** that the value in register *HEAD3* (07h,r) and *SUBH0-3* (14h-17h,r) are not available if *QMSF* (80h.w4) is set high.

If Q-channel extraction is enabled, device firmware can check flag *QCRCOK* (22h.r4) to see if there is a CRC error in the latest Q-channel information.

<example> SMD1 format setting:

- BIAH/L (09h/08h) = 000Ch
- CTRLW (10h.w) = 30h
- SICTL1 (2Ch.w) = 55h (SMD1 mode)
- **QEN** (80h.w5) = 1 and **QMSF** (80h.w4) = 1
- SDBS (88h.w4) = 1 and SBCK (88h.w3) = 1
- CTRL1 (0Bh.w) = 80h
- CTRL0 (0Ah.w) = 84h
- SCIB (01h.r0)
- SUBSTA (22h.r)

Following the above setting, there is no need to set SICTL (21h.w), SCBH/L (27h/26h,w) and SCTC (5Ah,w). In order to transfer the whole sector to host, 2352 bytes, the value in TWCH/L (03h/02h) should be 0497h and the value in TACH/L (05h/04h) should be 0000h.



5.4.10 Target Search

The target search logic is initialized by: (1) setting Search Limit, (2) setting Target and (3) setting *TARGEN* (80h.w7) high. After the decoding is triggered through *CTRL0* (0Ah,w), the first sector ready interrupt is generated when: i) the target sector is found, ii) header is larger than target or iii) search limit is reached. If event ii) or iii) occurs, the microprocessor may read out *HEAD0-2* (04h-06,r) to determine the current distance from target. Setting *LTTIEN* (80h.w2) and *TNFIEN* (80h.w1) high can generate the associated interrupt flag on *SRIb* (01h.r5) before the target is found.

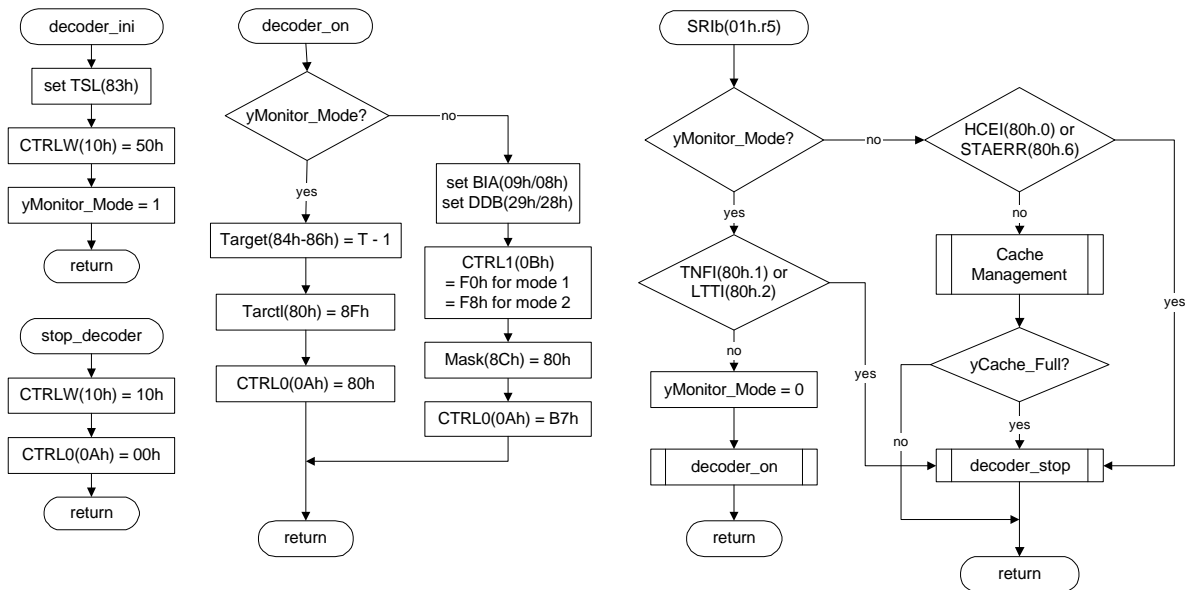

5.4.11 Automatic Header Comparison

The automatic header comparison logic is enabled by setting *TARGEN* (80h.w7) and *HCEEN* (80h.w0) high. After the first target is found, the value in *TARGET* (84h-86h) increases from (T - 1) to T. And the decoder is changed from disk-monitor mode to buffer-correction mode. Then *HEAD0-2* (04h-06h,r) are compare with *TARGET* (84h-86h) and generate flag *HCEI* (80h.r0) at the end of EDC-checking. Unless flag *STAERR* (80h.r6) or *HCEI* (80h.r0) is generated, the value in *TARGET* (84h-86h) is automatically incremented by one and ready to be compared with next sector.

5.4.12 Status Collection

The status collection logic is enabled if any bit in the *Status-Mask-Register* (8Ch-8Fh,w) is set high. At the end of EDC-checking, flag *STAERR* (80h.r6) becomes high if any status bit error that is enabled by its associating mask bit occurs. The microprocessor can reduce the system overhead by checking *STAERR* (80h.r6) rather than reading out *STAT* (0Ch-0Fh,r).



5.4.13 Decoder Processing Flow

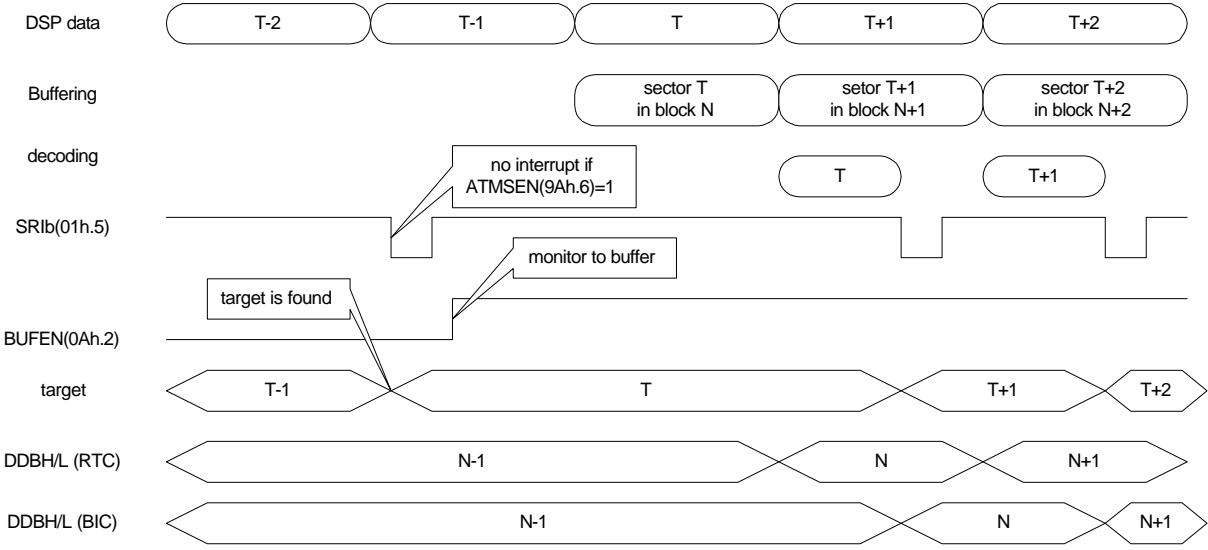

Note: (N - 1) is the value that set to DDBH/L

5.4.14 Buffer-Independent-Correction

Buffer-Independent-Correction (BIC) is enabled if BICEN (9Ah.7) is high. In BIC mode, the correction is triggered when the sectors not decoded in buffer is larger than one. In BIC mode, the DDBH/L (29h/28h) controls the decoding block and increments at the end of EDC-checking, except erroneous sectors. Meanwhile, the buffering block (internal) increments at each sync. Because of the independence of the buffering block and decoding block, the automatic repeat correction can be enabled by setting RCLIM3-0 (9Ch.3-0) the maximum rounds of repeat correction.

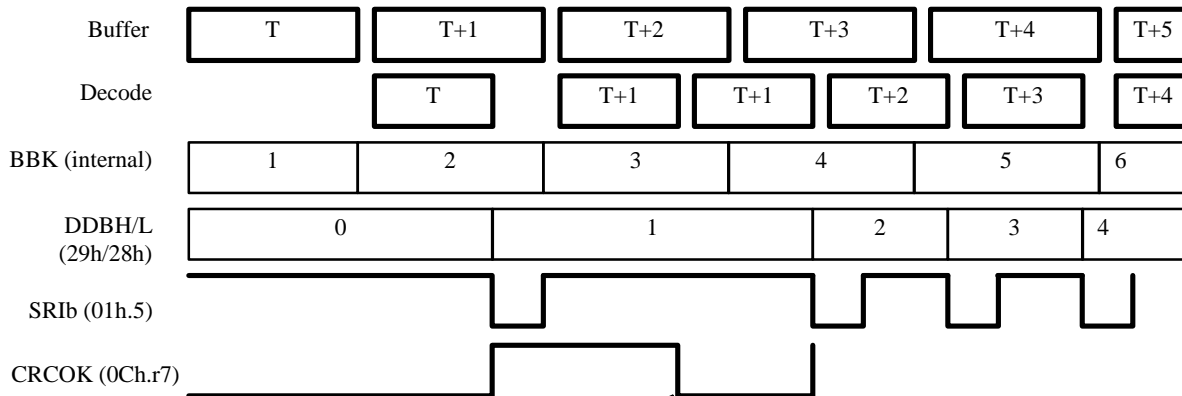

Automatic Repeat Correction triggered by CRC error of sector T+1 in first run



5.4.15 Remove Frequent SRIb & Automatic Cache Management

Control bit *RMSRI* (5Ch.0) should be set when entering buffer mode and be disabled in *decoder_off* routine. When *RMSRI* (5Ch.0) is high, flag *SRIb* (01h.r5) is generated only by *STAERR* (80h.r6), *LASTBK* (80h.r3) or *HCEI* (80h.r0).

So after the target is found and buffer-correction mode is enabled, the first interrupt is generated by *LASTBK* (80h.r3) if there is no decoding error. Setting *RMSRI* (5Ch.0) high can reduce the overhead of microcontroller while the automatic cache management is used.

Since the *SRIb* (01h.r5) interrupt is removed except for erroneous sectors, the cache management should be implemented through *TCC* (9Dh). If *TCINCEN* (9Ch.5) is high, *TCC* (9Dh) increments at the end of EDC-checking if there is no *STAERR* (80h.r6) or *HCEI* (80h.r0) error. If *ACMEN* (9Ch.6) is high, *TCC* (9Dh) decrements at the end of each data-in block transfer. The transfer of working area data should be implemented as linear transfer to prevent error.

Writing value to *SKIPC* (9Eh) can be used to implement the cache-partial-hit event. For the cache-miss event, *TCC* (9Dh) should be set 0.

The stop of DSP buffering is implemented by following setting initialization to prevent buffer wrap-around:

- *BICCTL* (9Ah) ← B0h
- *BUFLIM* (9Bh) ← *cache_limit*

The following figure shows an example flowchart under following conditions:

- Buffer-Independent-Correction is enabled
- Remove frequent SRIb is enabled in buffer mode
- Automatic transfer and cache management is enabled
- Linear address transfer for working area data is enabled

In this case, the flag *TENDb* (01h.r6) is generated only when the last block is transferred to host, i.e., *TTC* (9Fh) is zero.

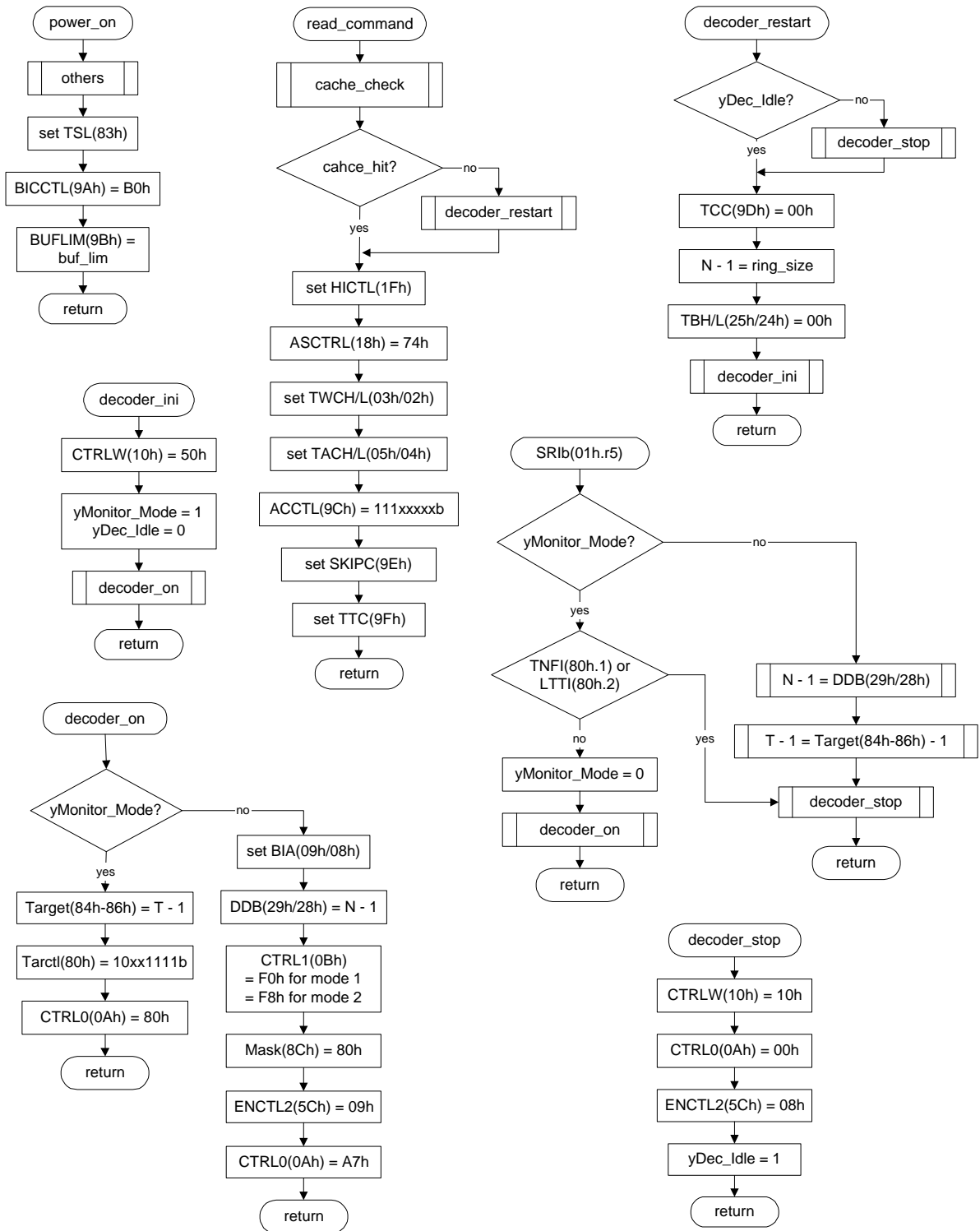



5.5 Audio-playback

5.5.1 Configuration Phase

1. Configure input/output pin for Audio-playback through *APCNF* (90h).
 - Bit 6: Audio Playback Interrupt Enable
 - Bit 4: Audio Reference Clock Select
 - Bit 3,2: Audio Input Reference Clock Setting
 - Bit 1:0: Audio Data Output Setting
2. Select Audio-playback output format through *APFMT* (91h).

After configuration, the *pins ABCK* (6) becomes active but data pin keep "mute."

5.5.2 Playback Phase

If the desired data sectors are buffered in DRAM, the following steps can trigger audio playback:

1. Set Audio-playback start block through *APBKHL* (93h/92h).
2. Enable Audio-playback by setting *APEN* (90h.7) high.
3. Wait for interrupt or polling flag *APIb* (01h.r2).
4. If *APIEN* (90h.6) is enabled, write *APACK* (97h,w) to deactivate audio-playback-interrupt.
5. If buffer is not empty or end of command, go to step 3.
6. Disable Audio-playback by setting *APEN* (90h.7) low.

The status of playback is directly controlled by the setting of *APEN* (90h.7). So the buffer should be carefully managed to prevent noise or broken song.

5.5.3 IEC-958 Digital Audio Output

The digital output function complies with the IEC-958 standard. This function is automatically enabled after configuration of audio playback function.

| DA0EN (87h.7) | HSTS1-0 (2Fh.w5-4) | ARST1-0 (2Fh.w3-2) | Digital Audio Output Pin | |
|------------------|-----------------------|-----------------------|--------------------------|---------|
| 1 | xxb | xxb | pin URS (32) | default |
| x | 01b | xxb | pin HRSTb (21) | |
| x | xxb | 01b | pin ARSTb (60) | |



5.5.4 Audio Playback Flowchart Example

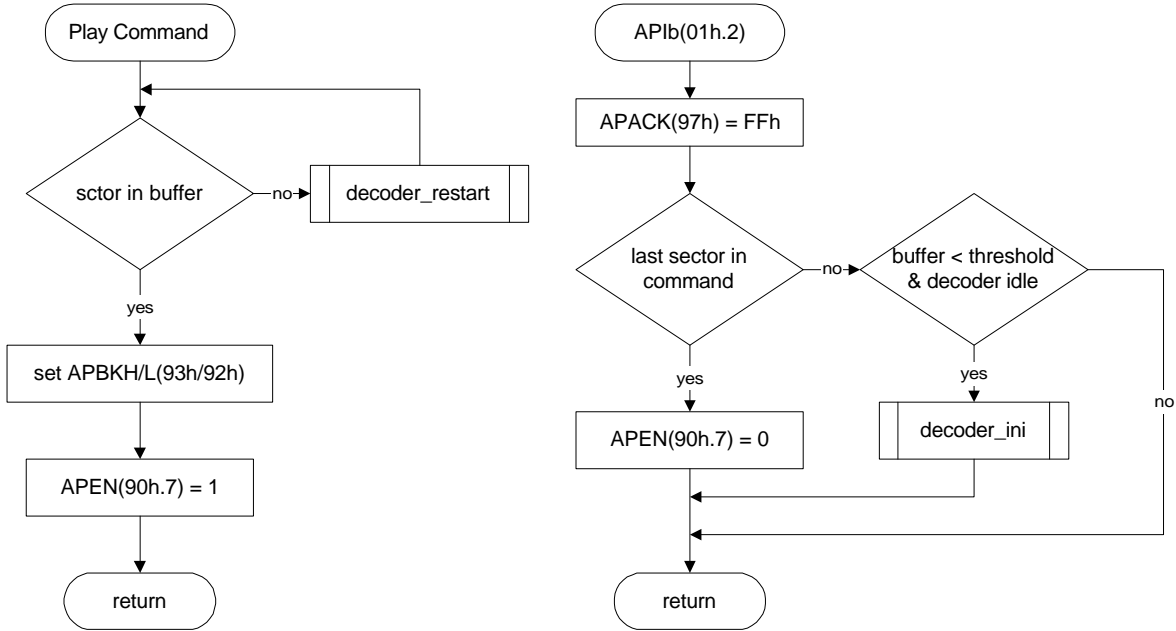



6. ORDERING INSTRUCTION

| Part No. | Package |
|----------|----------|
| W88113CF | PQFP 100 |
| W88113CD | LQFP 100 |

7. HOW TO READ THE TOP MARKING

Example: The top marking of W88113CF

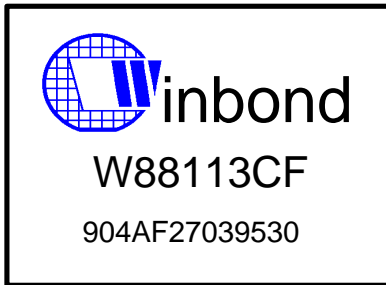

1st line: Winbond logo

2nd line: the type number: W88113CF

3rd line: Tracking code 904 A F 1 7039530

904: packages made in '99, week 4

A: assembly house ID; A means ASE, S means SPIL

F: IC revision; D means version D, F means version F

2: wafers manufactured in Winbond FAB 2

7039530: wafer production series lot number

8. PACKAGE DIMENSIONS

W88113CF (100-pin PQFP)

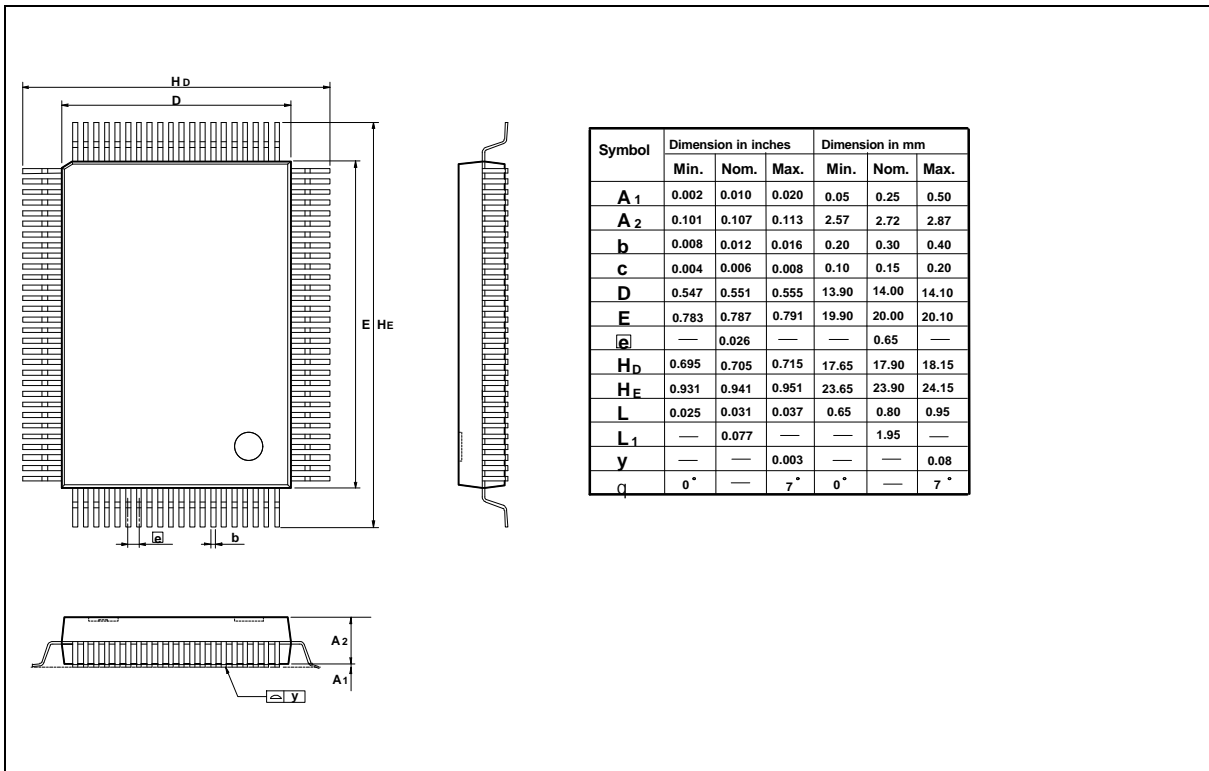



W88113CD (100-pin LQFP)

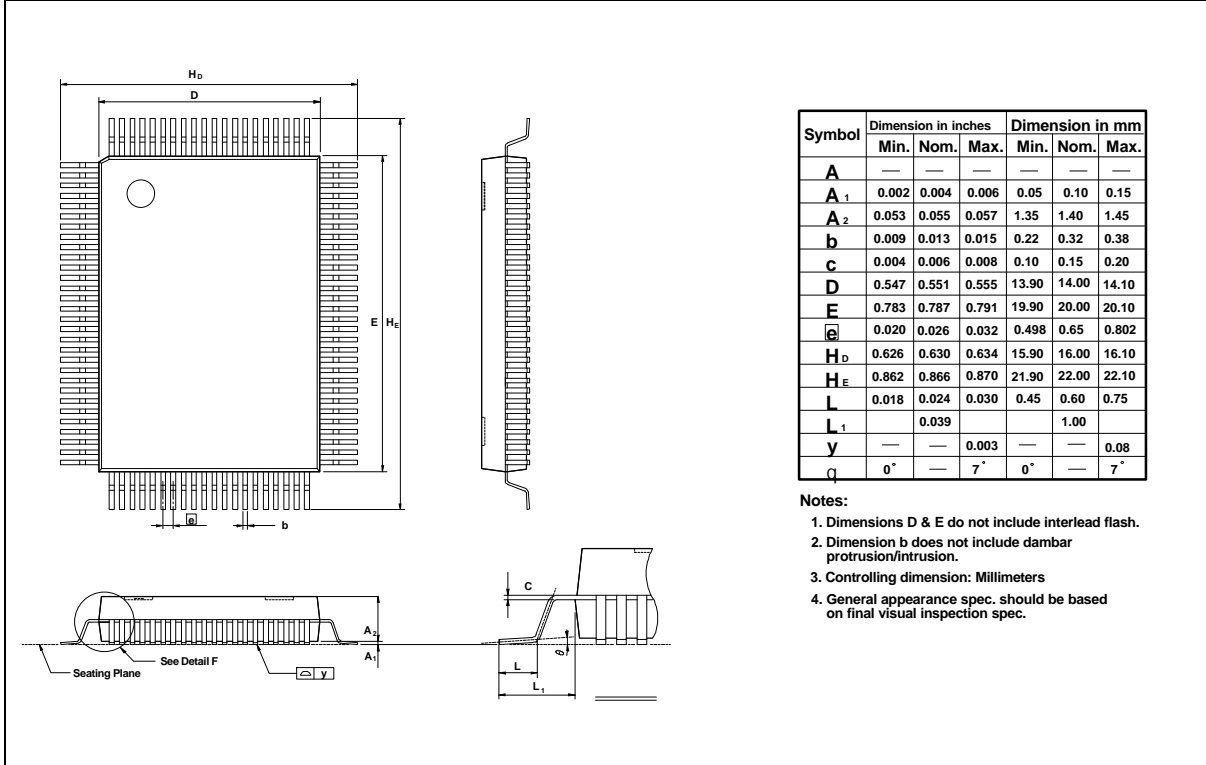

Headquarters
 No. 4, Creation Rd. III
 Science-Based Industrial Park
 Hsinchu, Taiwan
 TEL: 886-35-770066
 FAX: 886-35-789467
 www: <http://www.winbond.com.tw/>

Taipei Office
 11F, No. 115, Sec. 3, Min-Sheng East Rd.
 Taipei, Taiwan
 TEL: 886-2-7190505
 FAX: 886-2-7197502
 TLX: 16485 WINTPE

Winbond Electronics (H.K.) Ltd.
 Rm. 803, World Trade Square, Tower II
 123 Hoi Bun Rd., Kwun Tong
 Kowloon, Hong Kong
 TEL: 852-27516023-7
 FAX: 852-27552064

Winbond Electronics (North America) Corp.
 2730 Orchard Parkway
 San Jose, CA 95134 U.S.A.
 TEL: 1-408-9436666
 FAX: 1-408-9436668

Note: All data and specifications are subject to change without