

### FEATURES

- Reverse Blocking Capability
- Double Side Cooling
- High Reliability In Service
- High Voltage Capability
- Fault Protection Without Fuses
- High Surge Current Capability
- Turn-off Capability Allows Reduction In Equipment Size And Weight. Low Noise Emission Reduces Acoustic Cladding Necessary For Environmental Requirements

### APPLICATIONS

- Variable speed A.C. motor drive inverters (VSD-AC)
- Uninterruptable Power Supplies
- High Voltage Converters
- Choppers
- Welding
- Induction Heating
- DC/DC Converters

### KEY PARAMETERS

$I_{TCM}$	<b>700A</b>
$V_{DRM}/V_{RRM}$	<b>1300V</b>
$I_{T(AV)}$	<b>250A</b>
$dV_D/dt$	<b>500V/μs</b>
$di_T/dt$	<b>500A/μs</b>

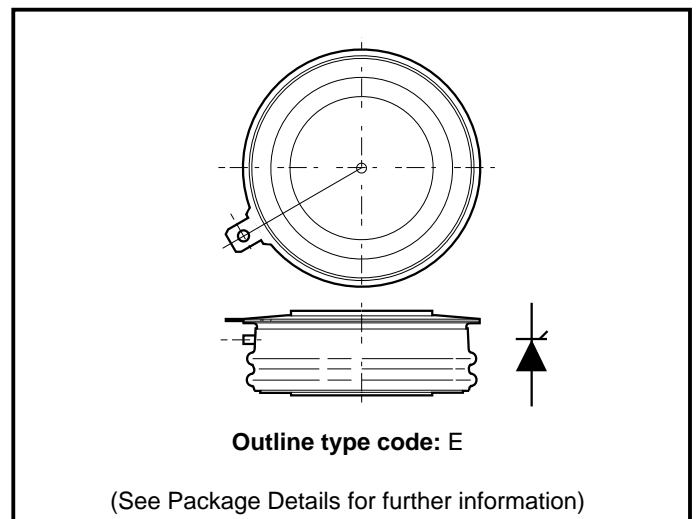

**Fig. 1 Package outline**

### VOLTAGE RATINGS

Type Number	Repetitive Peak Off-state Voltage $V_{DRM}$ V	Repetitive Peak Reverse Voltage $V_{RRM}$ V	Conditions
DGT304RE13	1300	1300	$T_{vj} = 125^{\circ}C, I_{DM} = 50mA,$ $I_{RRM} = 50mA, V_{RG} = 2V$

## CURRENT RATINGS

Symbol	Parameter	Conditions	Max.	Units
$I_{TCM}$	Repetitive peak controllable on-state current	$V_D = 60\%V_{DRM}$ , $T_j = 125^\circ\text{C}$ , $di_{GQ}/dt = 15\text{A}/\mu\text{s}$ , $C_s = 2.0\mu\text{F}$	700	A
$I_{T(AV)}$	Mean on-state current	$T_{HS} = 80^\circ\text{C}$ . Double side cooled. Half sine 50Hz.	250	A
$I_{T(RMS)}$	RMS on-state current	$T_{HS} = 80^\circ\text{C}$ . Double side cooled. Half sine 50Hz.	390	A

## SURGE RATINGS

Symbol	Parameter	Conditions	Max.	Units
$I_{TSM}$	Surge (non-repetitive) on-state current	10ms half sine. $T_j = 125^\circ\text{C}$	4.0	kA
$I^2t$	$I^2t$ for fusing	10ms half sine. $T_j = 125^\circ\text{C}$	80000	$\text{A}^2\text{s}$
$di_T/dt$	Critical rate of rise of on-state current	$V_D = 60\% V_{DRM}$ , $I_T = 700\text{A}$ , $T_j = 125^\circ\text{C}$ , $I_{FG} > 20\text{A}$ , Rise time $< 1.0\mu\text{s}$	500	$\text{A}/\mu\text{s}$
$dV_D/dt$	Rate of rise of off-state voltage	To 80% $V_{DRM}$ ; $R_{GK} \leq 1.5\Omega$ , $T_j = 125^\circ\text{C}$	500	$\text{V}/\mu\text{s}$

## GATE RATINGS

Symbol	Parameter	Conditions	Min.	Max.	Units
$V_{RGM}$	Peak reverse gate voltage	This value maybe exceeded during turn-off	-	16	V
$I_{FGM}$	Peak forward gate current		-	50	A
$P_{FG(AV)}$	Average forward gate power		-	10	W
$P_{RGM}$	Peak reverse gate power		-	6	kW
$di_{GQ}/dt$	Rate of rise of reverse gate current		10	50	$\text{A}/\mu\text{s}$
$t_{ON(min)}$	Minimum permissible on time		20	-	$\mu\text{s}$
$t_{OFF(min)}$	Minimum permissible off time		40	-	$\mu\text{s}$

**THERMAL RATINGS**

Symbol	Parameter	Conditions	Min.	Max.	Units	
$R_{th(j-hs)}$	DC thermal resistance - junction to heatsink surface	Double side cooled	-	0.075	°C/W	
		Anode side cooled	-	0.12	°C/W	
		Cathode side cooled	-	0.20	°C/W	
$R_{th(c-hs)}$	Contact thermal resistance	Clamping force 5.5kN With mounting compound	per contact	-	0.018	°C/W
$T_{vj}$	Virtual junction temperature		-	125	°C	
$T_{OP}/T_{stg}$	Operating junction/storage temperature range		-40	125	°C	
-	Clamping force		5.0	6.0	kN	

**CHARACTERISTICS**

$T_j = 125^\circ\text{C}$ unless stated otherwise					
Symbol	Parameter	Conditions	Min.	Max.	Units
$V_{TM}$	On-state voltage	At 600A peak, $I_{G(ON)} = 2\text{A d.c.}$	-	2.2	V
$I_{DM}$	Peak off-state current	At $V_{DRM}$ , $V_{RG} = 2\text{V}$	-	25	mA
$I_{RRM}$	Peak reverse current	At $V_{RRM}$	-	50	mA
$V_{GT}$	Gate trigger voltage	$V_D = 24\text{V}$ , $I_T = 100\text{A}$ , $T_j = 25^\circ\text{C}$	-	0.9	V
$I_{GT}$	Gate trigger current	$V_D = 24\text{V}$ , $I_T = 100\text{A}$ , $T_j = 25^\circ\text{C}$	-	1.0	A
$I_{RGM}$	Reverse gate cathode current	$V_{RGM} = 16\text{V}$ , No gate/cathode resistor	-	50	mA
$E_{ON}$	Turn-on energy	$V_D = 900\text{V}$ , $I_T = 600\text{A}$ , $di_T/dt = 300\text{A}/\mu\text{s}$	-	130	mJ
$t_d$	Delay time	$I_{FG} = 20\text{A}$ , rise time $< 1.0\mu\text{s}$	-	1.5	$\mu\text{s}$
$t_r$	Rise time	$R_L = (\text{Residual inductance } 3\mu\text{H})$	-	3.0	$\mu\text{s}$
$E_{OFF}$	Turn-off energy		-	350	mJ
$t_{gs}$	Storage time	$I_T = 600\text{A}$ , $V_{DM} = 750\text{V}$	-	10	$\mu\text{s}$
$t_{gf}$	Fall time	Snubber Cap $C_s = 1.5\mu\text{F}$ ,	-	11	$\mu\text{s}$
$t_{gq}$	Gate controlled turn-off time	$di_{GQ}/dt = 15\text{A}/\mu\text{s}$	-	0.9	$\mu\text{s}$
$Q_{GQ}$	Turn-off gate charge	$R_L = (\text{Residual inductance } 3\mu\text{H})$	-	700	$\mu\text{C}$
$Q_{GQT}$	Total turn-off gate charge		-	1400	$\mu\text{C}$

CURVES

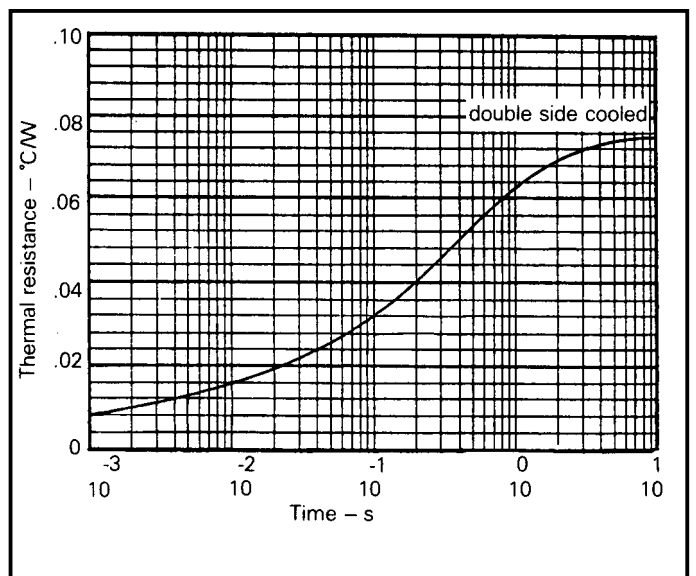
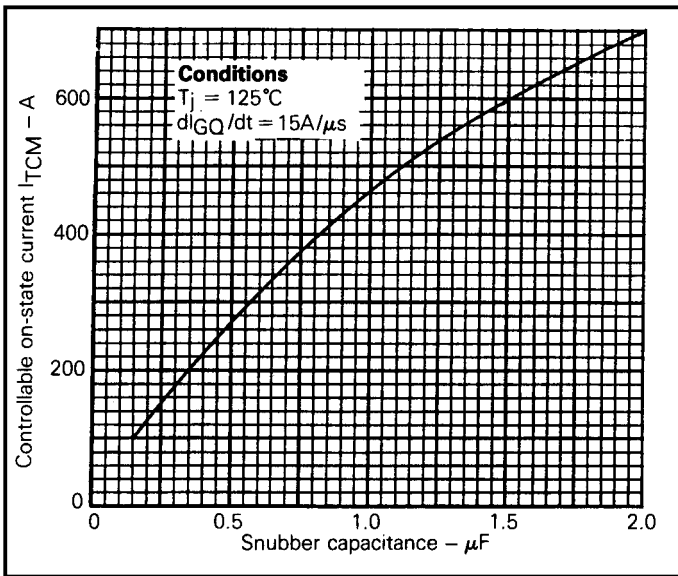
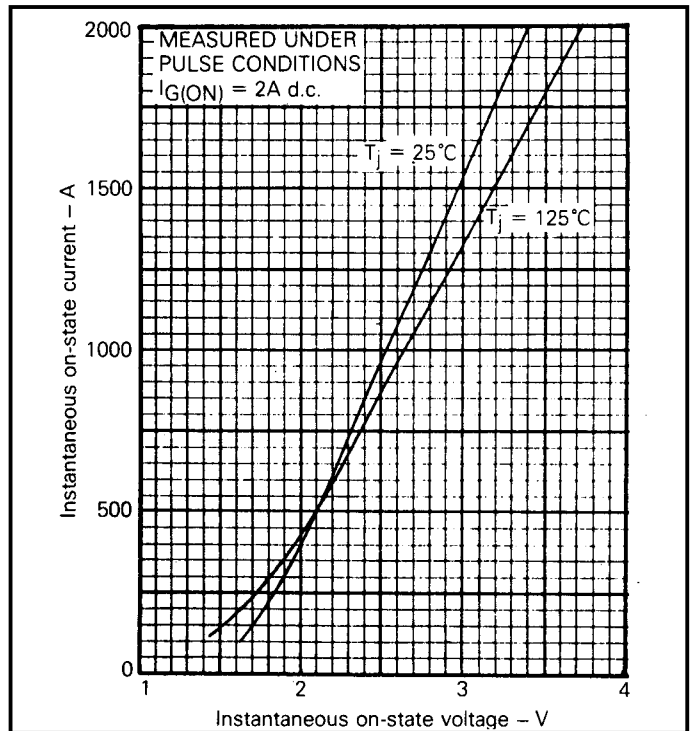
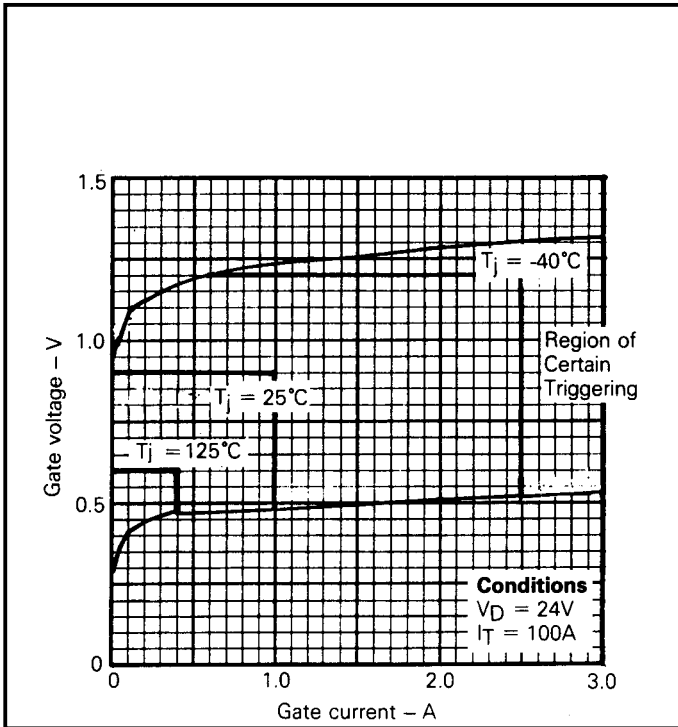

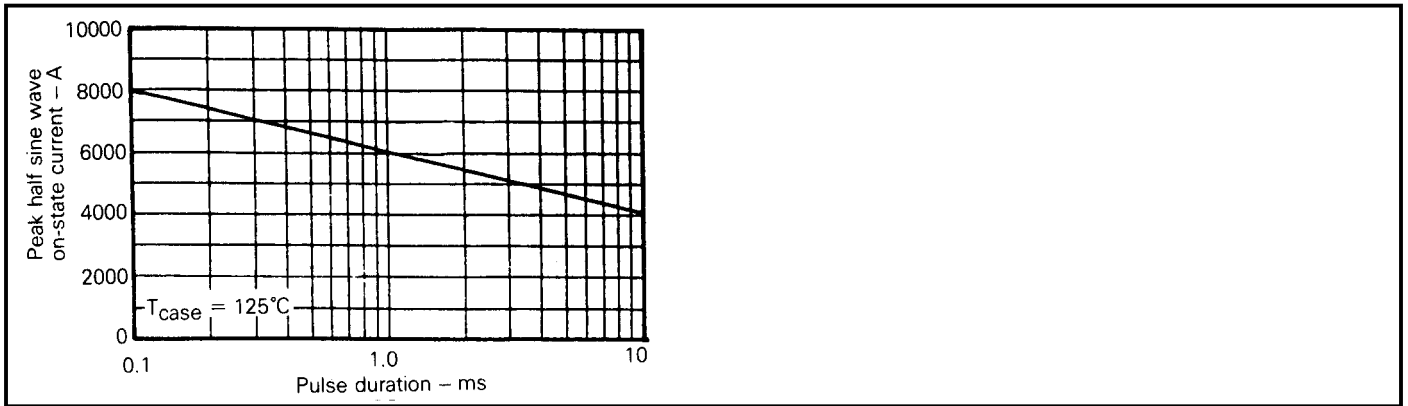

**Fig.6 Surge (non-repetitive) on-state current vs time**

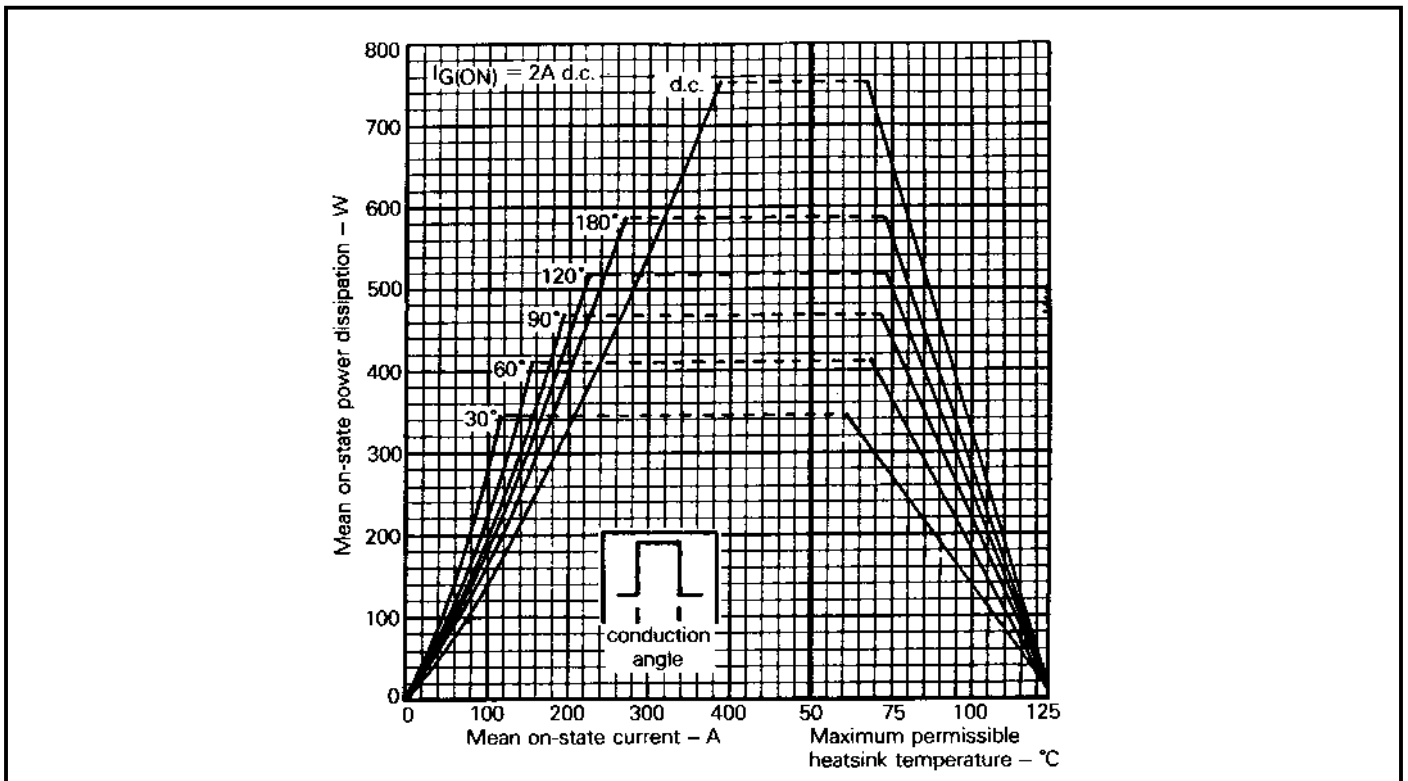

**Fig.7 Steady state rectangular wave conduction loss - double side cooled**

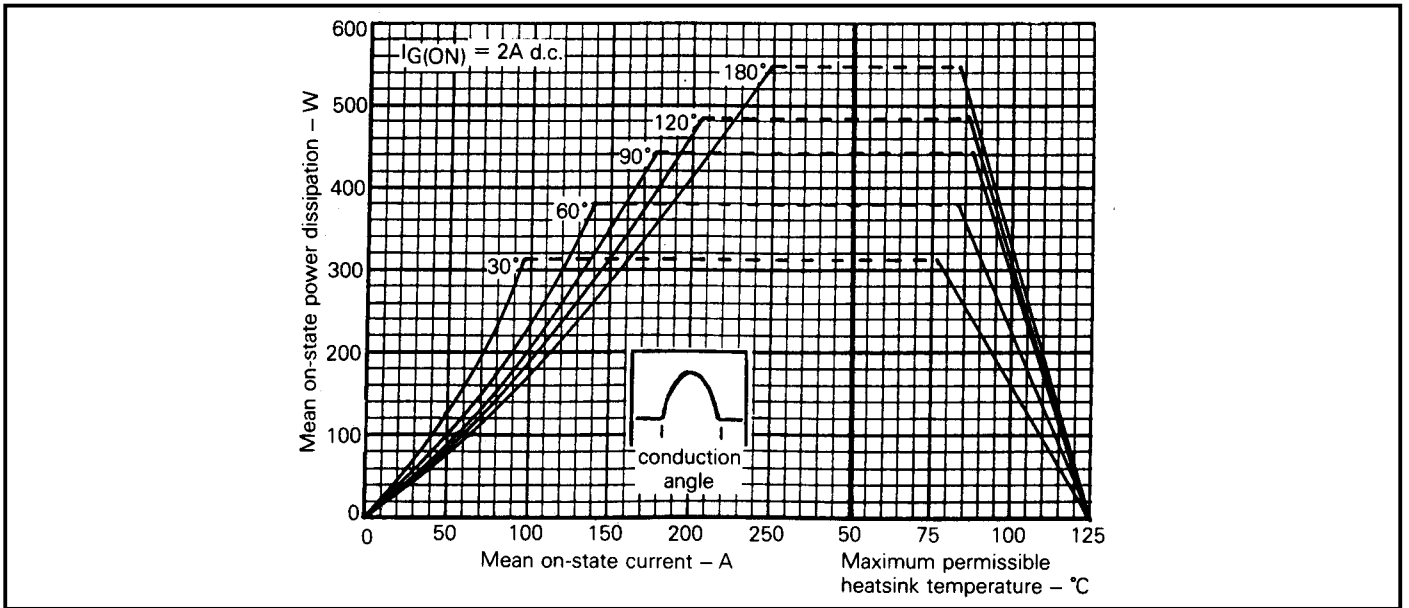

Fig.8 Steady state sinusoidal wave conduction loss - double side cooled

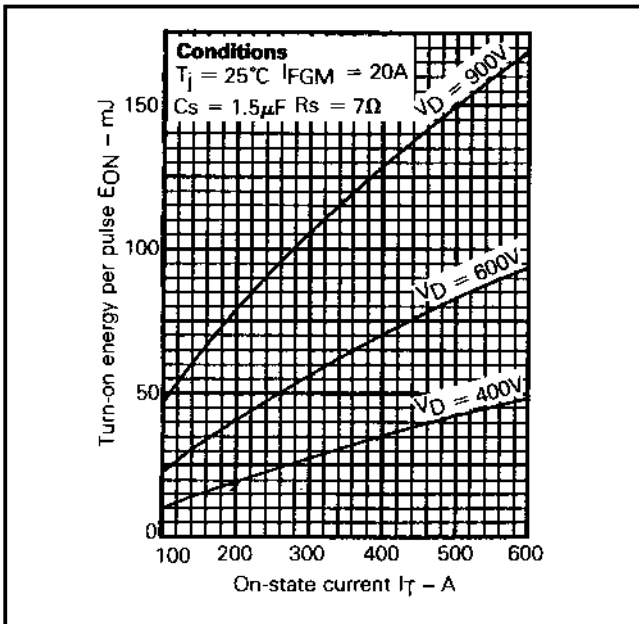

Fig.9 Turn-on energy vs on-state current

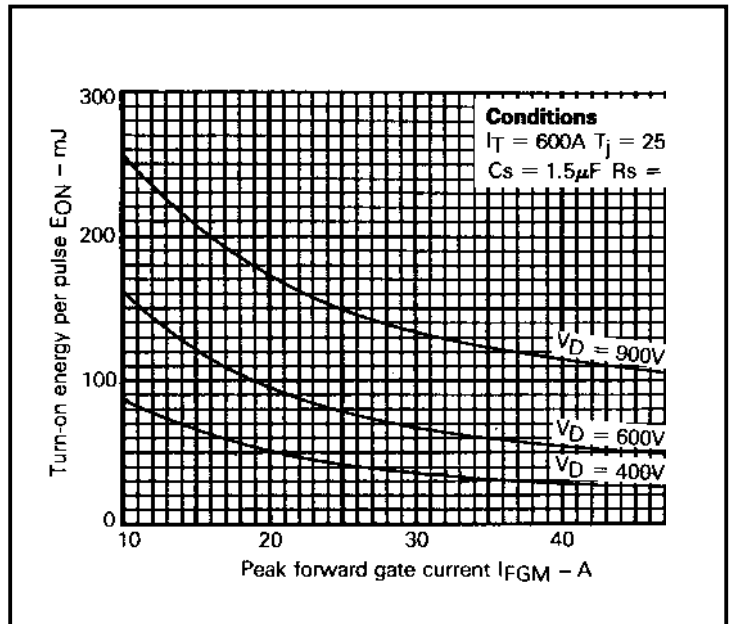

Fig.10 Turn-on energy vs peak forward gate current

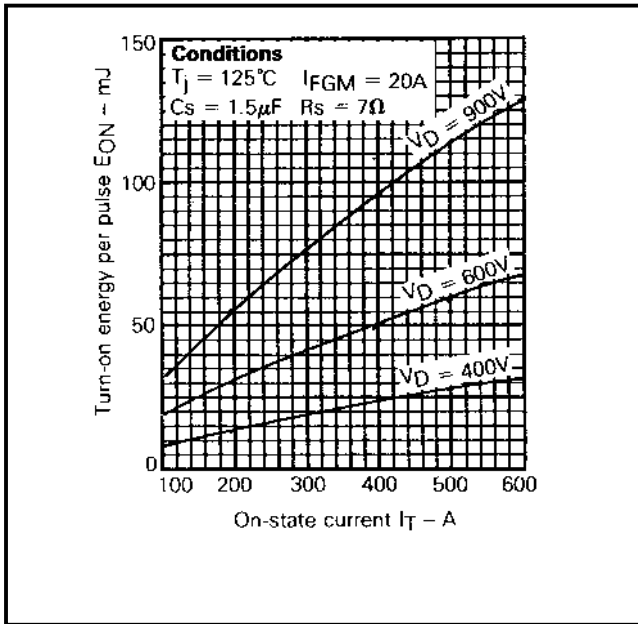

Fig.11 Turn-on energy vs on-state current

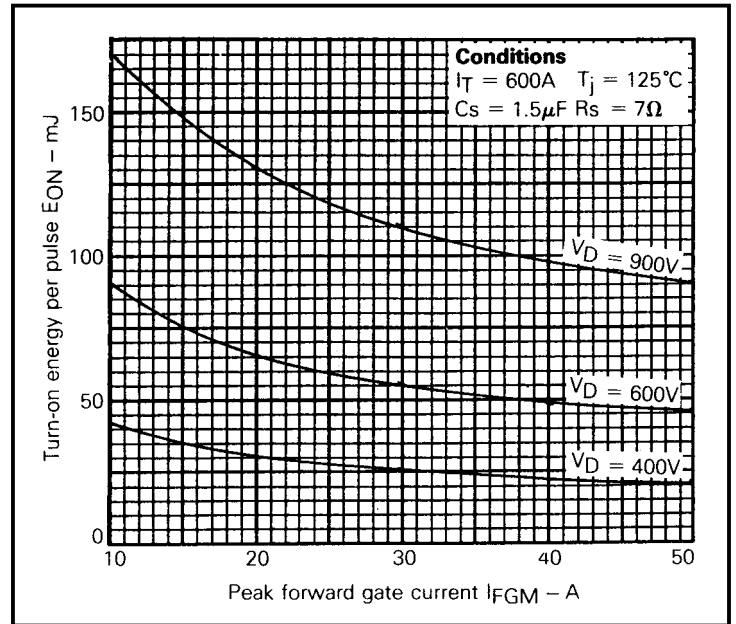

Fig.12 Turn-on energy vs peak forward gate current

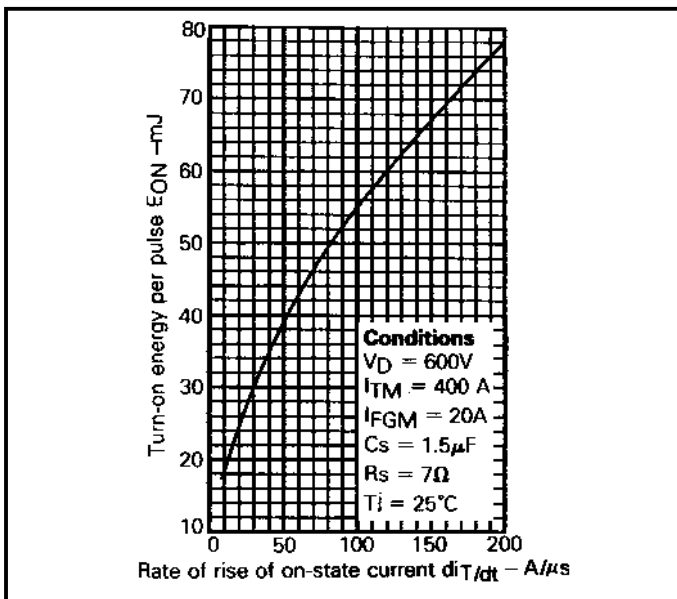

Fig.13 Turn-on energy vs rate of rise of on-state current

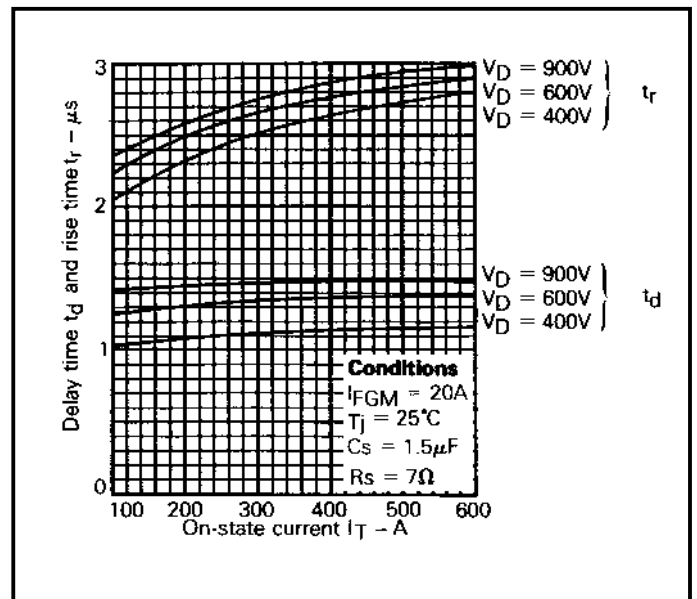

Fig.14 Delay time and rise time vs on-state current

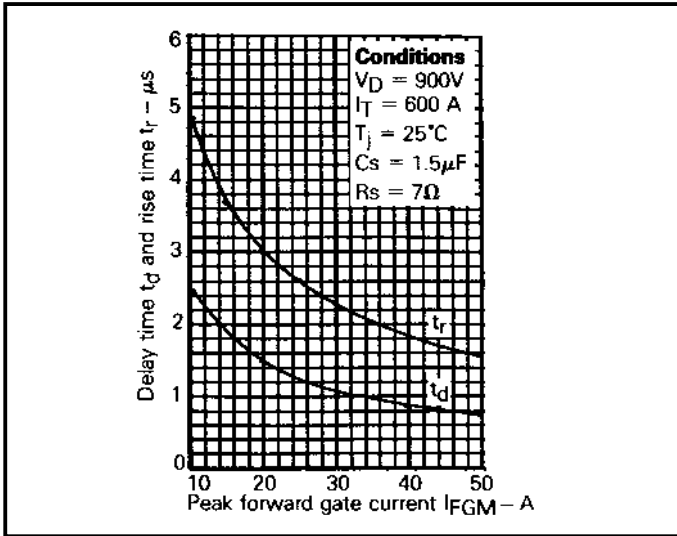

Fig.15 Delay time and rise time vs peak forward gate current

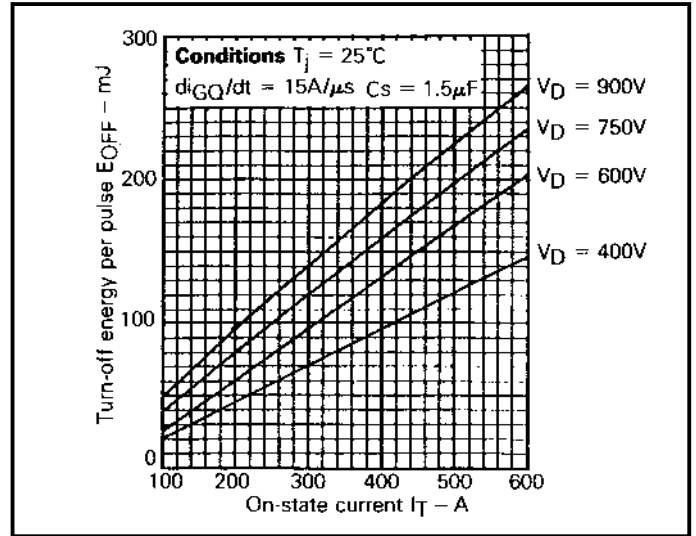

Fig.16 Turn-off energy vs on-state current

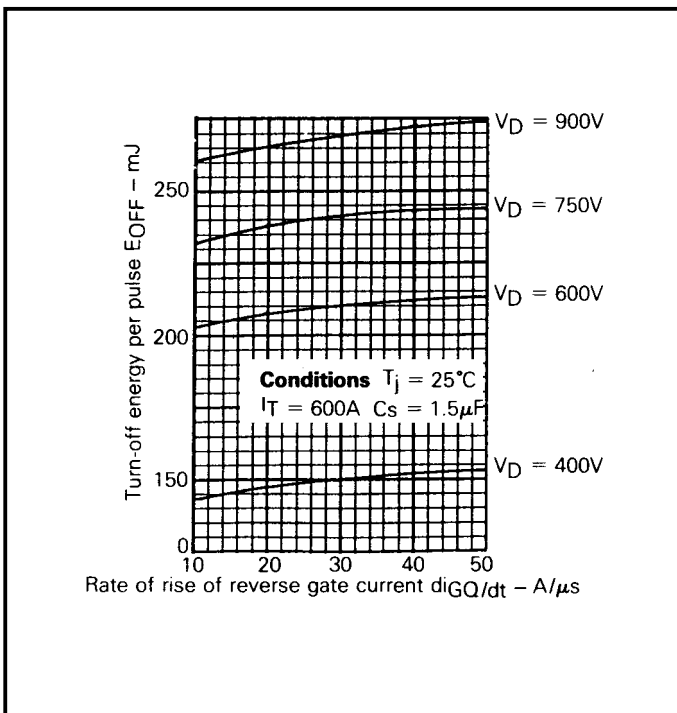

Fig.17 Turn-off energy vs rate of rise of reverse gate current

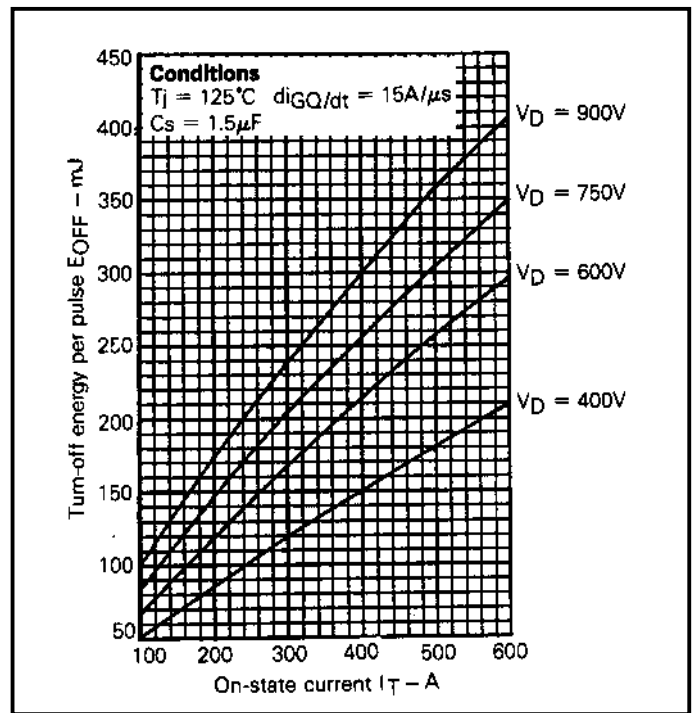

Fig.18 Turn-off energy vs on-state current



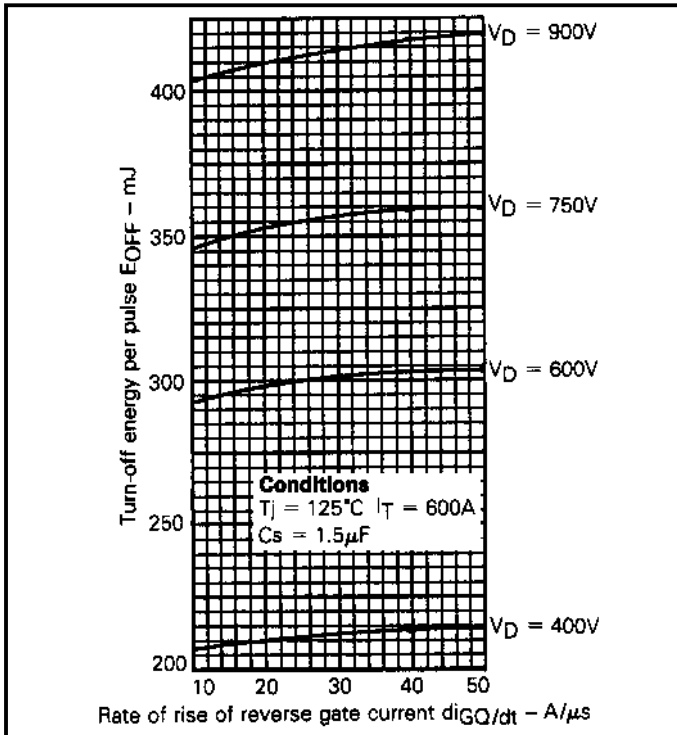

Fig.19 Turn-off energy vs rate of rise of reverse gate current

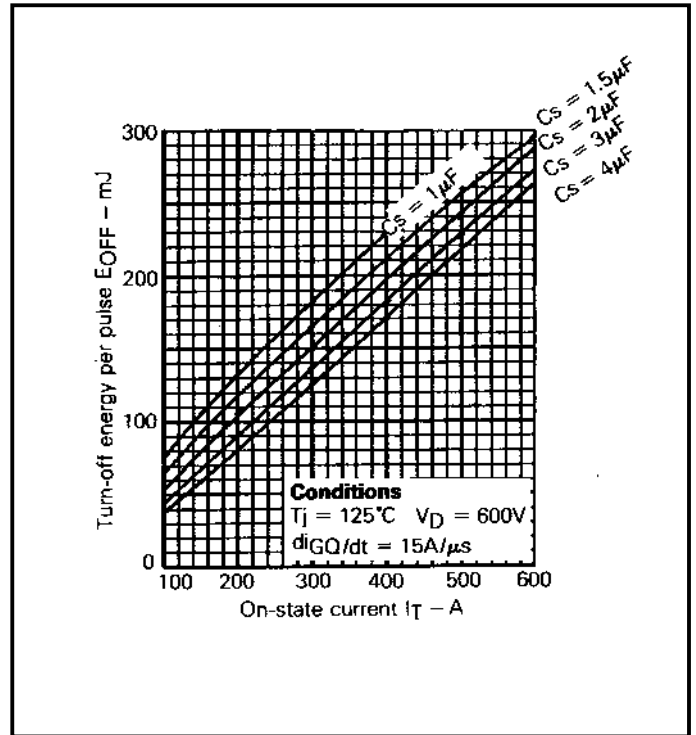

Fig.20 Turn-off energy vs on-state current with  $C_s$  as parameter

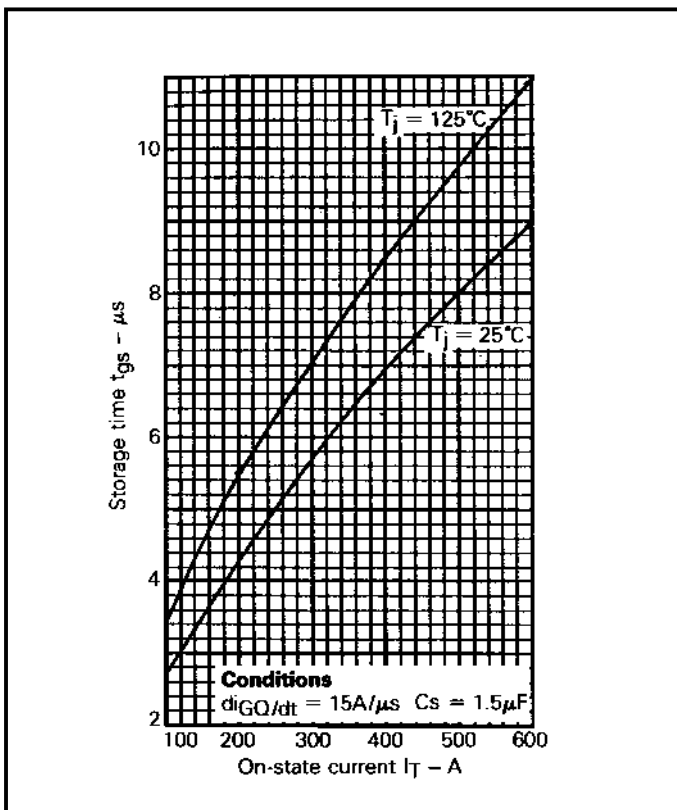

Fig.21 Storage time vs on-state current

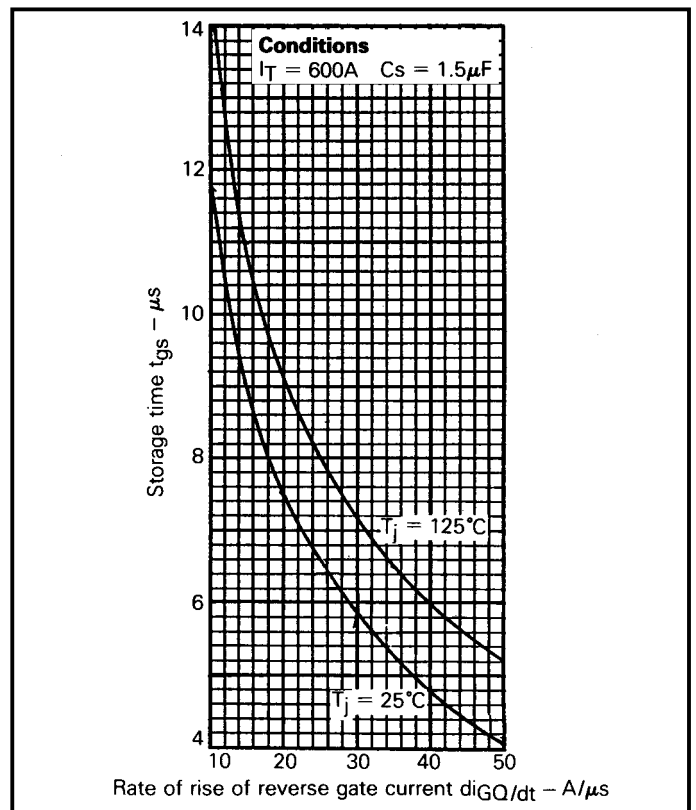

Fig.22 Storage time vs rate of rise of reverse gate current

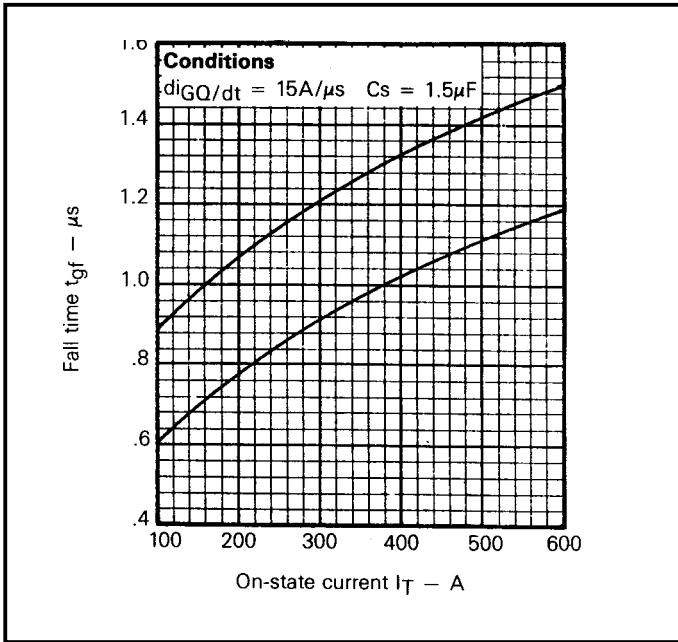

Fig.23 Fall time vs on-state current

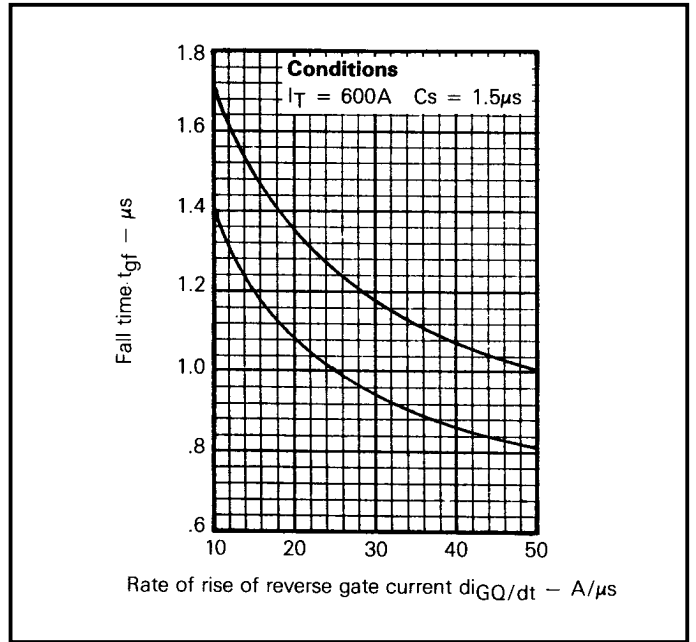

Fig.24 Fall time vs rate of rise of reverse gate current

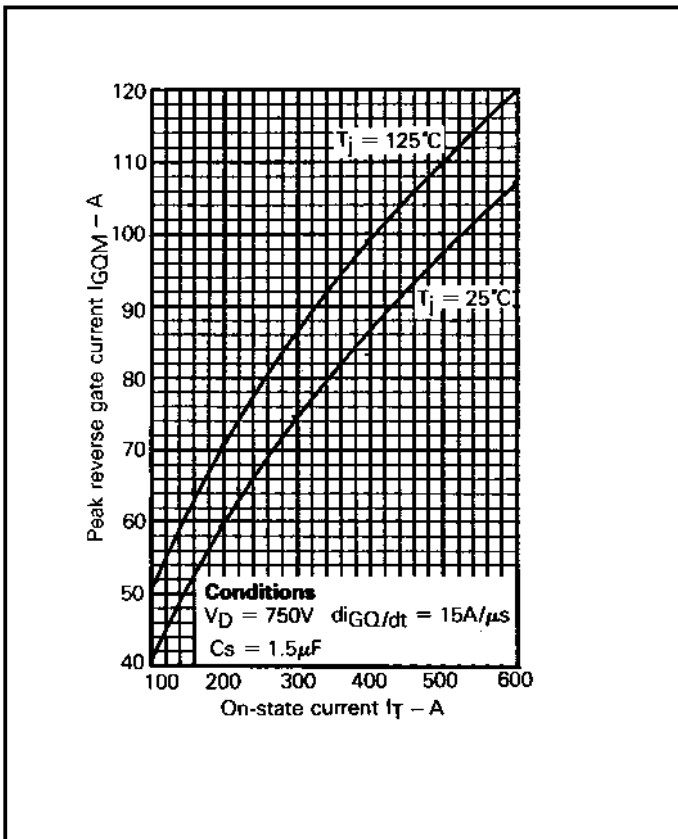

Fig.25 Peak reverse gate current vs on-state current

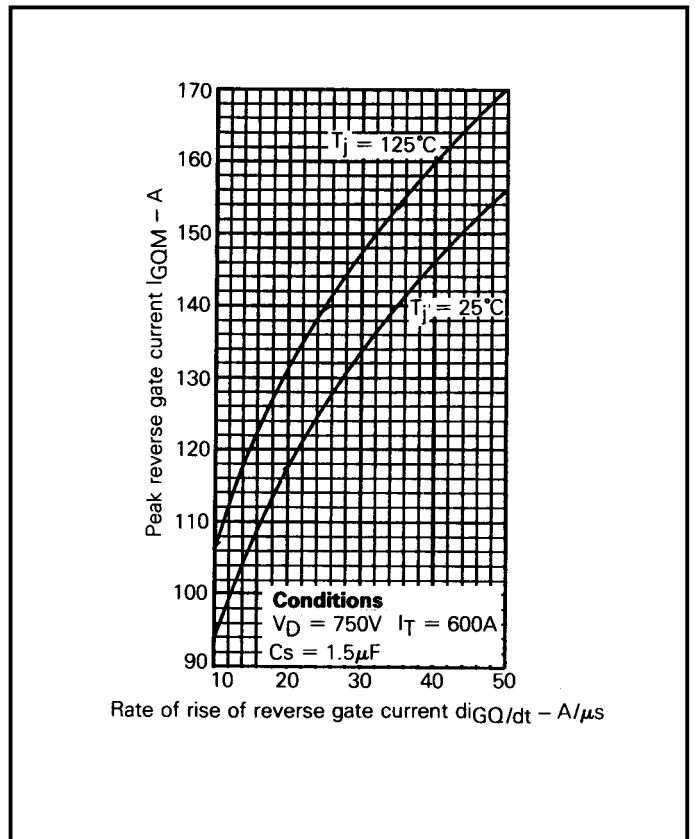
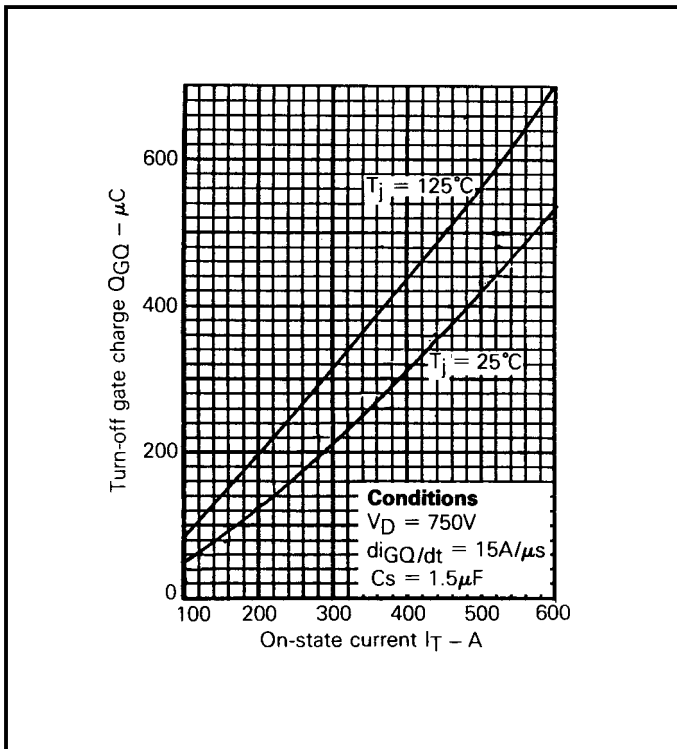
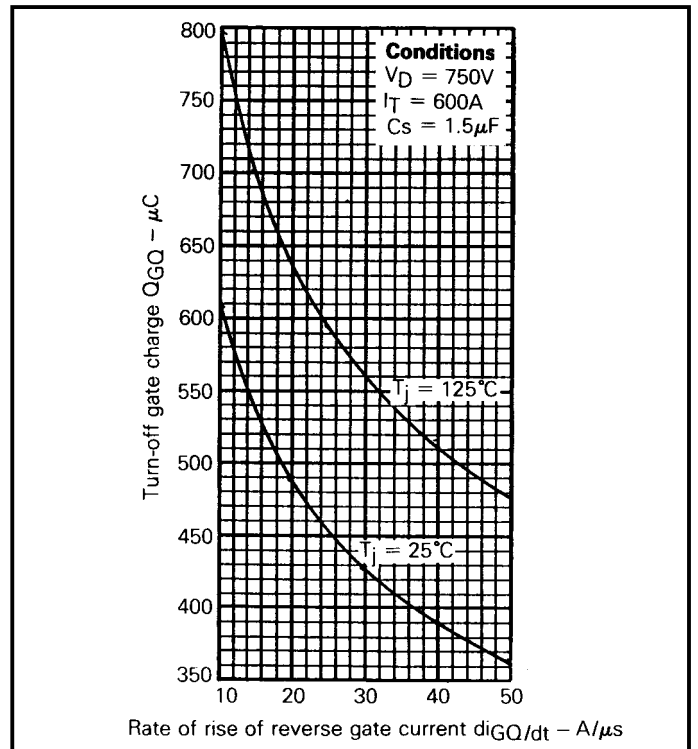

Fig.26 Peak reverse gate current vs rate of rise of reverse gate current



**Fig.27 Turn-off gate charge vs on-state current**



**Fig.28 Turn-off gate charge vs rate of rise of reverse gate current**

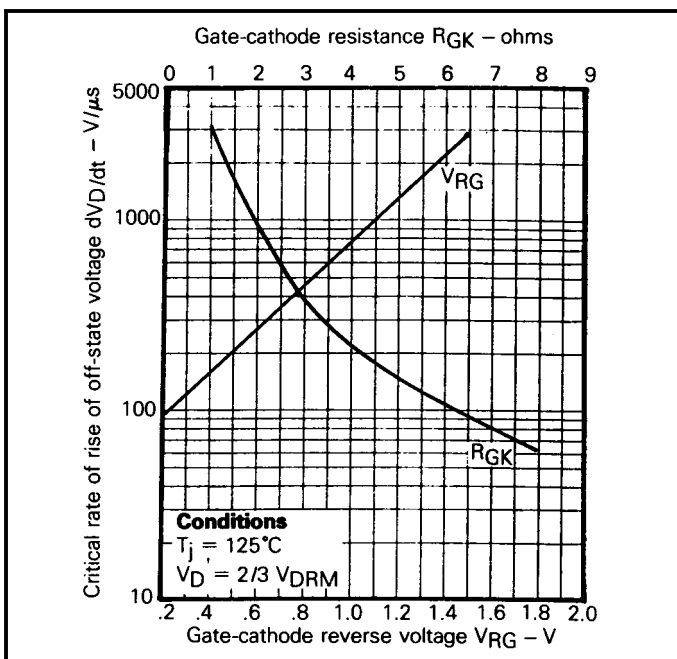

**Fig.29 Dependence of critical  $dV_d/dt$  on gate-cathode resistance and gate-cathode reverse voltage**

Snubber Capacitor $C_s$ ( $\mu F$ )	Snubber Resistor $R_s$ ( $\Omega$ )	Minimum Reset Time ( $\mu s$ )
2	7	35
	5	30
1.5	7	26
	5	22
1	7	17
	5	15

**Table of snubber discharge time variation with snubber capacitor value.**

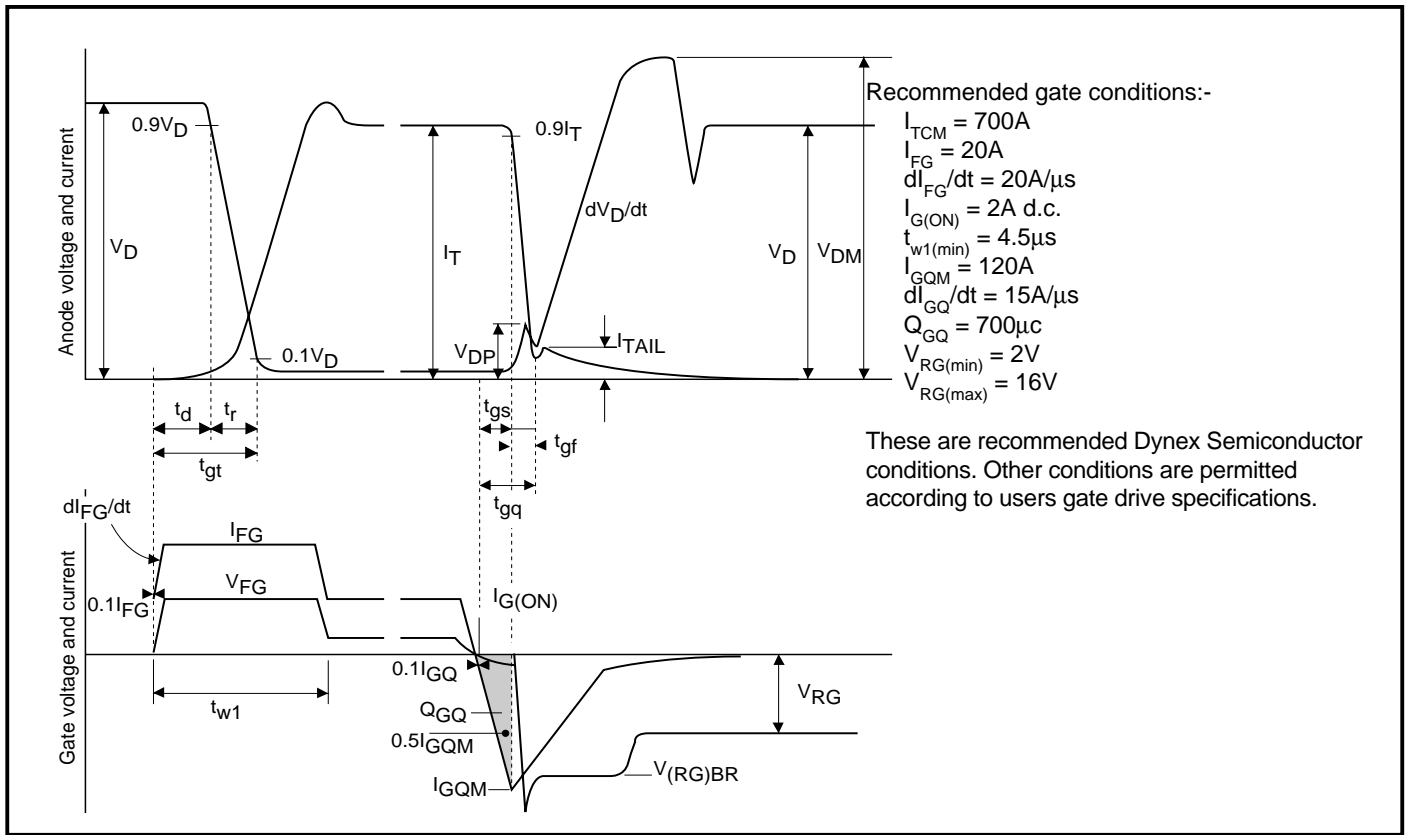
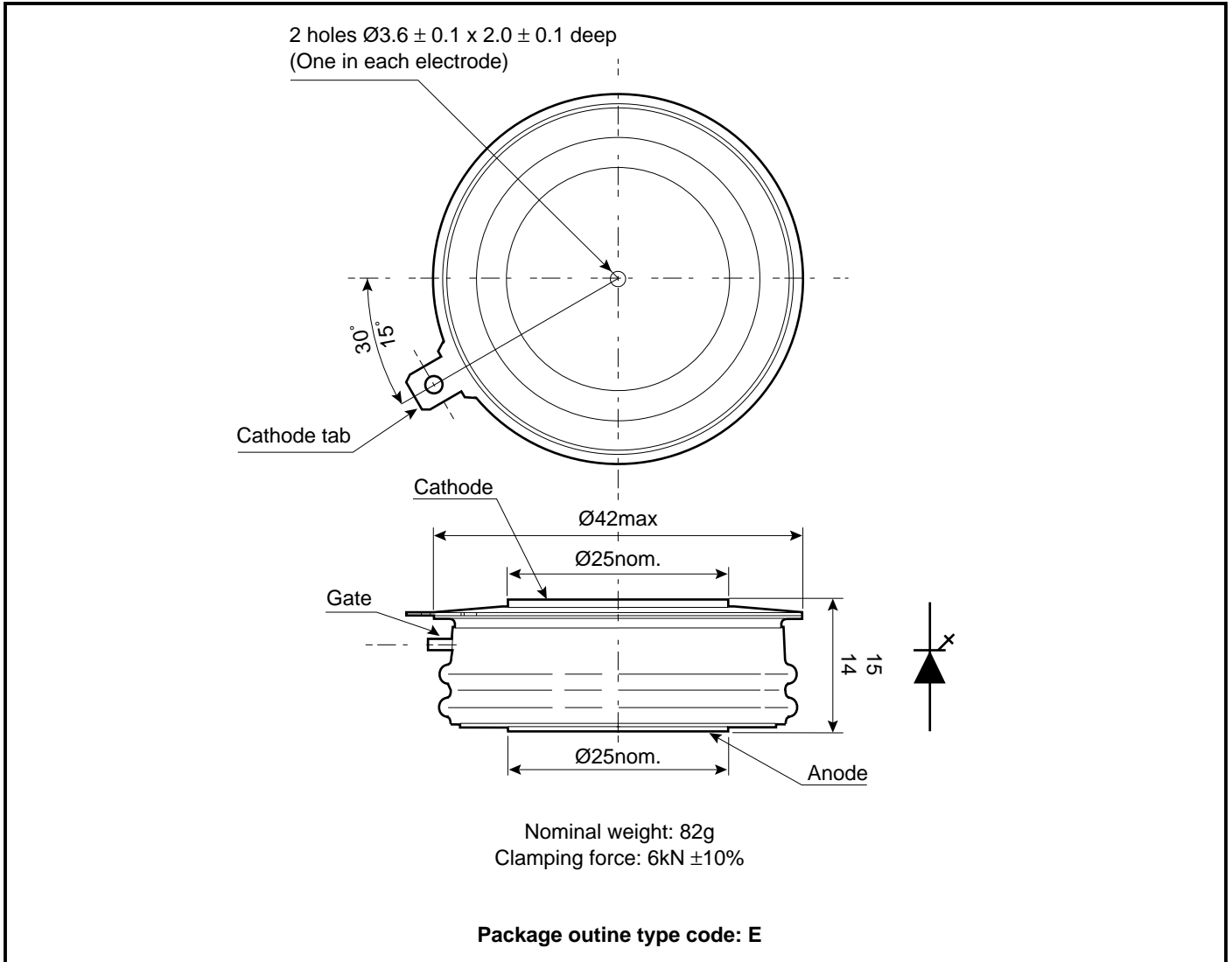

Fig.30 General switching waveforms

**PACKAGE DETAILS**

For further package information, please visit our website or contact Customer Services. All dimensions in mm, unless stated otherwise. DO NOT SCALE.



**ASSOCIATED PUBLICATIONS**

Title	Application Note
	Number
Calculating the junction temperature or power semiconductors	AN4506
GTO gate drive units	AN4571
Recommendations for clamping power semiconductors	AN4839
Use of $V_{TO}$ , $r_T$ on-state characteristic	AN5001
Improved gate drive for GTO series connections	AN5177

## POWER ASSEMBLY CAPABILITY

The Power Assembly group was set up to provide a support service for those customers requiring more than the basic semiconductor, and has developed a flexible range of heatsink and clamping systems in line with advances in device voltages and current capability of our semiconductors.

We offer an extensive range of air and liquid cooled assemblies covering the full range of circuit designs in general use today. The Assembly group continues to offer high quality engineering support dedicated to designing new units to satisfy the growing needs of our customers.

Using the latest CAD methods our team of design and applications engineers aim to provide the Power Assembly Complete Solution (PACs).

## DEVICE CLAMPS

Disc devices require the correct clamping force to ensure their safe operation. The PACS range includes a varied selection of pre-loaded clamps to suit all of our manufactured devices. Types available include cube clamps for single side cooling of 'T' 23mm and 'E' 30mm discs, and bar clamps right up to 83kN for our 'Z' 100mm thyristors and diodes.

Clamps are available for single or double side cooling, with high insulation versions for high voltage assemblies.

Please refer to our application note on device clamping, AN4839

## HEATSINKS

The Power Assembly group has its own proprietary range of extruded aluminium heatsinks. They have been designed to optimise the performance of Dynex semiconductors. Data with respect to air natural, forced air and liquid cooling (with flow rates) is available on request.

For further information on device clamps, heatsinks and assemblies, please contact your nearest sales representative or Customer Services.



<http://www.dynexsemi.com>

e-mail: [power\\_solutions@dynexsemi.com](mailto:power_solutions@dynexsemi.com)

HEADQUARTERS OPERATIONS  
**DYNEX SEMICONDUCTOR LTD**  
 Doddington Road, Lincoln.  
 Lincolnshire. LN6 3LF. United Kingdom.  
 Tel: 00-44-(0)1522-500500  
 Fax: 00-44-(0)1522-500550

CUSTOMER SERVICES  
 Tel: +44 (0)1522 502753/502901. Fax: +44 (0)1522 500020

SALES OFFICES  
**North America** Tel: (613) 723-7035. Fax: (613) 723-1518. Toll Free: 1.888.33.DYNEX (39639) /  
 Tel: (949) 733-3005. Fax: (949) 733-2986.  
**Rest Of World** Tel: +44 (0)1522 502753/502901. Fax: +44 (0)1522 500020

These offices are supported by Representatives and Distributors in many countries world-wide.  
 © Dynex Semiconductor 2002 Publication No. DS5518-2 Issue No. 2.1 February 2002  
 TECHNICAL DOCUMENTATION – NOT FOR RESALE. PRODUCED IN UNITED KINGDOM

### Datasheet Annotations:

Dynex Semiconductor annotate datasheets in the top right hand corner of the front page, to indicate product status. The annotations are as follows:-

**Target Information:** This is the most tentative form of information and represents a very preliminary specification. No actual design work on the product has been started.

**Preliminary Information:** The product is in design and development. The datasheet represents the product as it is understood but details may change.

**Advance Information:** The product design is complete and final characterisation for volume production is well in hand.

**No Annotation:** The product parameters are fixed and the product is available to datasheet specification.

This publication is issued to provide information only which (unless agreed by the Company in writing) may not be used, applied or reproduced for any purpose nor form part of any order or contract nor to be regarded as a representation relating to the products or services concerned. No warranty or guarantee express or implied is made regarding the capability, performance or suitability of any product or service. The Company reserves the right to alter without prior notice the specification, design or price of any product or service. Information concerning possible methods of use is provided as a guide only and does not constitute any guarantee that such methods of use will be satisfactory in a specific piece of equipment. It is the user's responsibility to fully determine the performance and suitability of any equipment using such information and to ensure that any publication or data used is up to date and has not been superseded. These products are not suitable for use in any medical products whose failure to perform may result in significant injury or death to the user. All products and materials are sold and services provided subject to the Company's conditions of sale, which are available on request.

All brand names and product names used in this publication are trademarks, registered trademarks or trade names of their respective owners.