



No.3192

**LA6358NM**

**High-Performance  
Dual Operational Amplifier**

**Overview**

The LA6358NM is an IC integrating two high-performance operational amplifiers in a single package. This operational amplifier contains an internal phase compensator and is designed to operate from a single power supply over a wide range of voltages. As with conventional general-purpose operational amplifiers, operation from dual power supplies is also possible and power dissipation is very low. This IC can be used widely in commercial and industrial applications including various transducer amplifiers and DC amplifiers.

**Features**

- Eliminates need for phase compensation
- Wide range of operating supply voltage : 3.0 to 30.0V (single power supply)  
±1.5 to ±15.0V (dual power supply)
- Input voltage swingable down to nearly ground level and output voltage range  $V_{OUT}$  of 0 to  $V_{CC} - 1.5V$
- Low current dissipation :  $I_{CC} = 0.5mA$  typ/ $V_{CC} = +5V, R_L = \infty$
- Miniflat package permitting the LA6358NM-applied sets to be made small

**Maximum Ratings at  $T_a = 25^\circ C$**

			unit
Maximum Supply Voltage	$V_{CC}$	32	V
Differential Input Voltage	$V_{ID}$	32	V
Maximum Input Voltage	$V_{IN\ max}$	-0.3 to +32	V
Allowable Power Dissipation	$P_d\ max$	300	mW
Operating Temperature	$T_{opr}$	-30 to +85	$^\circ C$
Storage Temperature	$T_{stg}$	-55 to +125	$^\circ C$

**Operating Characteristics at  $T_a = 25^\circ C, V_{CC} = +5V$**

			Test Circuit	min	typ	max	unit
Input Offset Voltage	$V_{IO}$		1		±2	±7	mV
Input Offset Current	$I_{IO}$	$I_{IN(+)} / I_{IN(-)}$	2		±5	±50	nA
Input Bias Current	$I_B$	$I_{IN(+)} / I_{IN(-)}$	3		45	250	nA
Common-mode Input Voltage Range	$V_{ICM}$		4	0	$V_{CC} - 1.5$		V

Continued on next page.

**Equivalent Circuit (1 unit)**

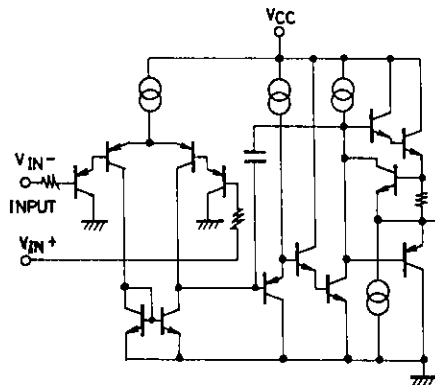

**Pin Assignment**

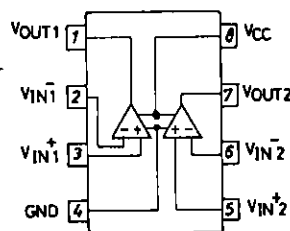

**Package Dimensions 3032B-M81C (unit : mm)**

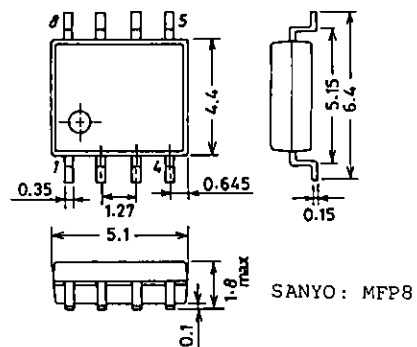

# LA6358NM

Continued from preceding page.

			Test Circuit	min	typ	max	unit
Common-mode Rejection Ratio	CMR		4	65	80		dB
Large Signal Voltage Gain	V <sub>G</sub>	V <sub>CC</sub> = 15V, R <sub>L</sub> ≥ 2kΩ	5	25	100		V/mV
Output Voltage Range	V <sub>OUT</sub>			0	V <sub>CC</sub> - 1.5		V
Power Supply Rejection Ratio	SVR		6	65	100		dB
Channel Separation		f = 1k to 20kHz	7		120		dB
Current Dissipation	I <sub>CC</sub>		8		0.5	1.2	mA
Output Current (Source)	I <sub>O source</sub>	V <sub>IN+</sub> = 1V, V <sub>IN-</sub> = 0V	9	20	40		mA
Output Current (Sink)	I <sub>O sink</sub>	V <sub>IN+</sub> = 0V, V <sub>IN-</sub> = 1V	10	10	20		mA

## Test Circuits

### 1. Input Offset Voltage V<sub>IO</sub>

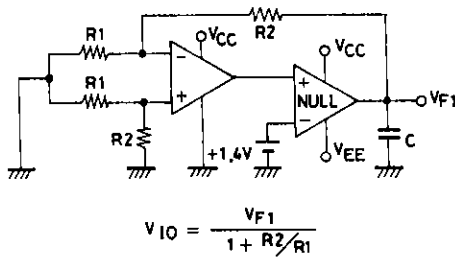

### 2. Input Offset Current I<sub>IO</sub>

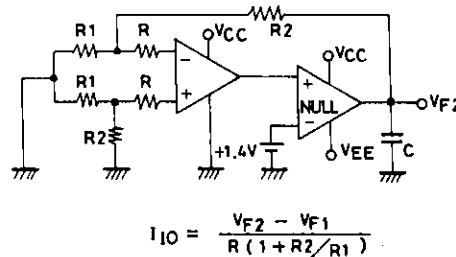

### 3. Input Bias Current I<sub>B</sub>

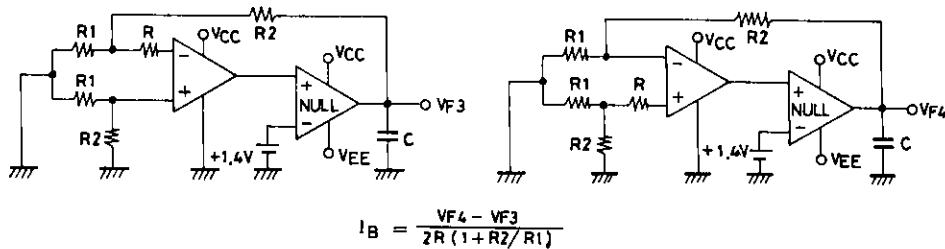

### 4. Common-mode Rejection Ratio CMR Common-mode Input Voltage Range V<sub>ICM</sub>

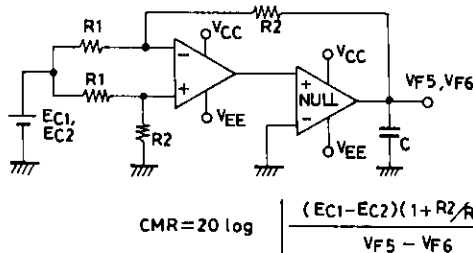

### 5. Voltage Gain V<sub>G</sub>

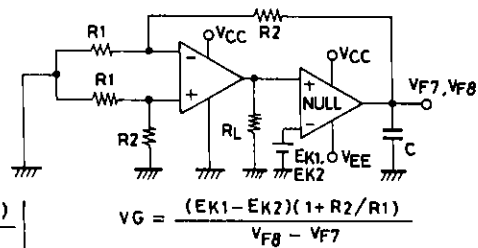

### 6. Supply Voltage Rejection SVR

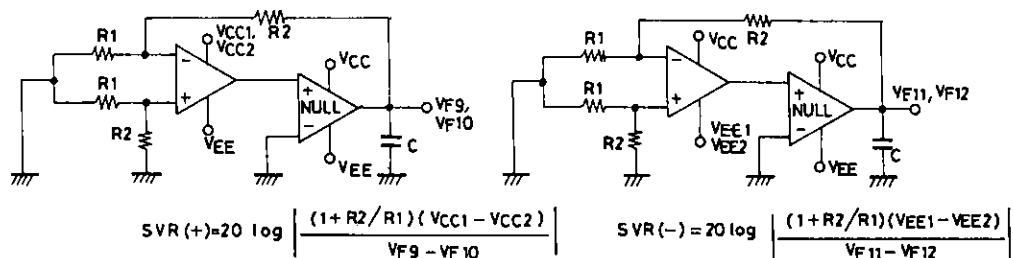

7. Channel Separation CS

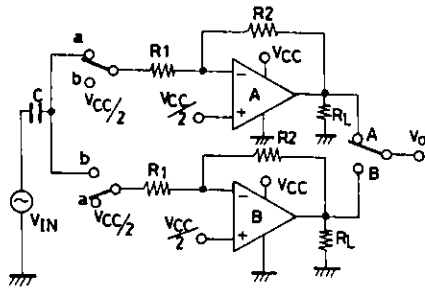

SW : a

$$CS(A \rightarrow B) + 20 \log \frac{R_2 V_{OA}}{R_1 V_{OB}}$$

SW : b

$$CS(B \rightarrow A) + 20 \log \frac{R_2 V_{OB}}{R_1 V_{OA}}$$

8. Current Dissipation  $I_{CC}$

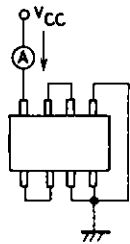

9. Output Current  $I_{O\ source}$

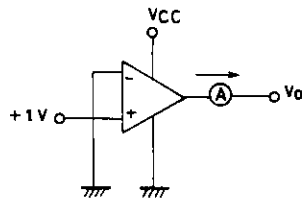

10. Output Current  $I_{O\ sink}$

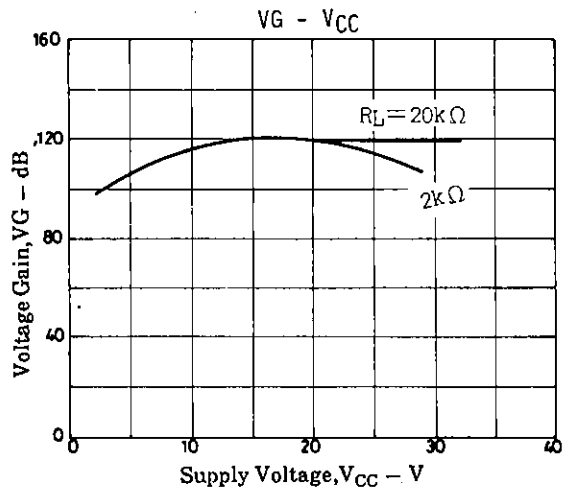
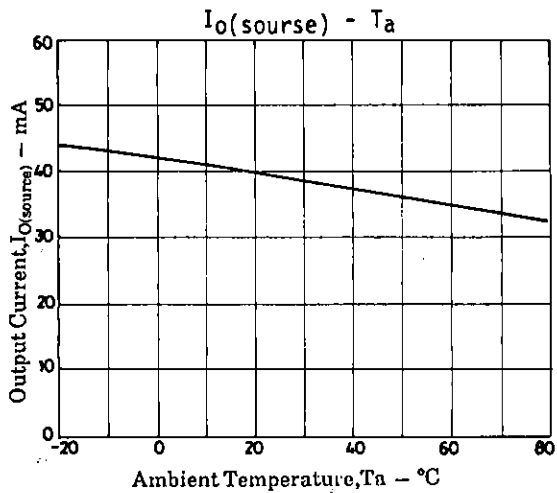
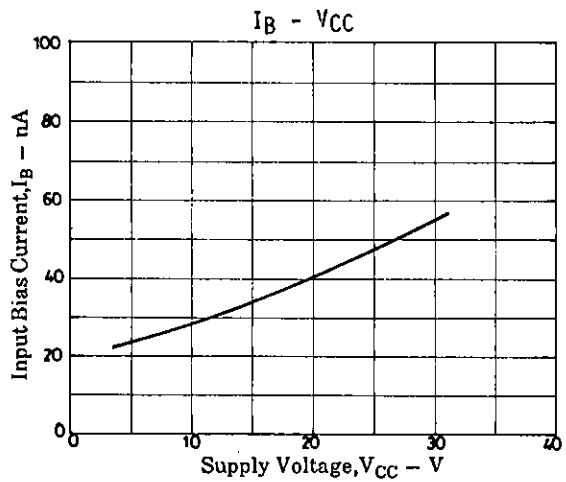
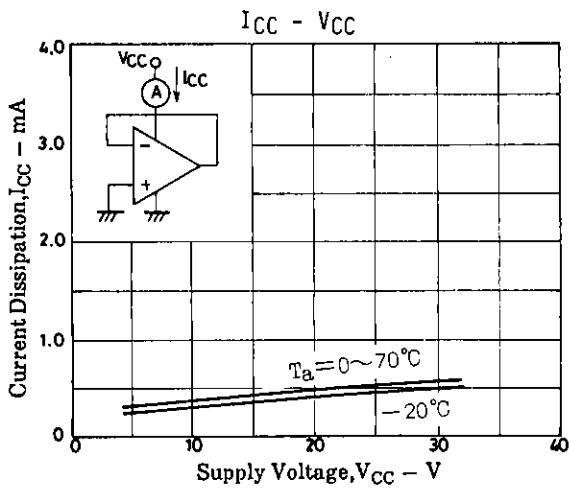
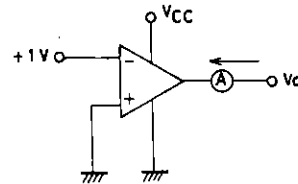

# LA6358NM

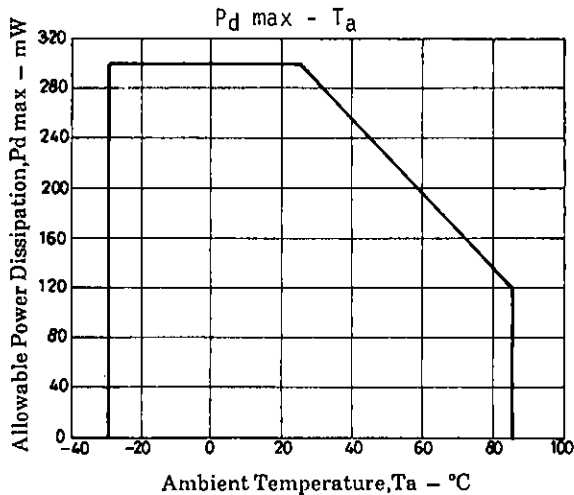
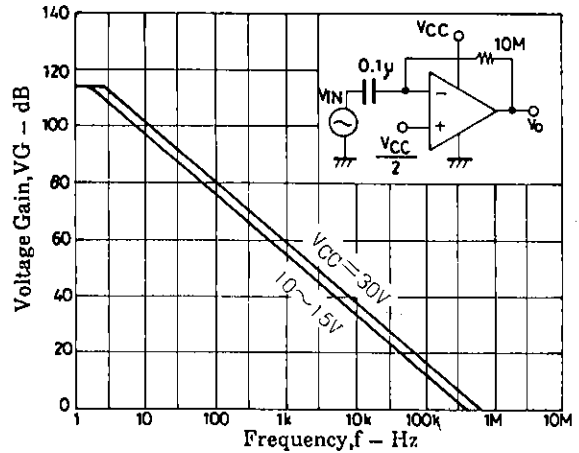
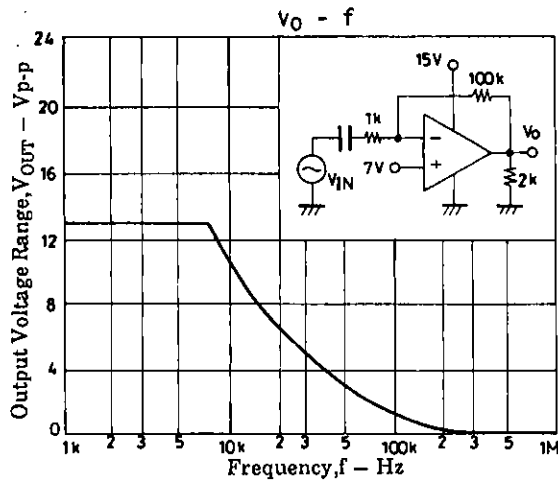

## Sample Application Circuits

### Noninverting DC amplifier

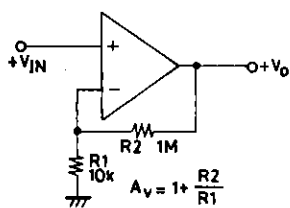

### Inverting AC amplifier

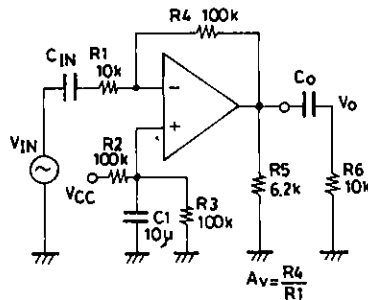

### Rectangular wave oscillator

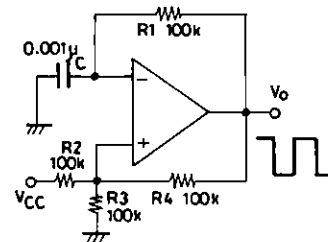

Unit (resistance:  $\Omega$ , capacitance: F)

- No products described or contained herein are intended for use in surgical implants, life-support systems, aerospace equipment, nuclear power control systems, vehicles, disaster/crime-prevention equipment and the like, the failure of which may directly or indirectly cause injury, death or property loss.
- Anyone purchasing any products described or contained herein for an above-mentioned use shall:
  - ① Accept full responsibility and indemnify and defend SANYO ELECTRIC CO., LTD., its affiliates, subsidiaries and distributors and all their officers and employees, jointly and severally, against any and all claims and litigation and all damages, cost and expenses associated with such use:
  - ② Not impose any responsibility for any fault or negligence which may be cited in any such claim or litigation on SANYO ELECTRIC CO., LTD., its affiliates, subsidiaries and distributors or any of their officers and employees jointly or severally.
- Information (including circuit diagrams and circuit parameters) herein is for example only; it is not guaranteed for volume production. SANYO believes information herein is accurate and reliable, but no guarantees are made or implied regarding its use or any infringements of intellectual property rights or other rights of third parties.