

TOSHIBA BIPOLAR DIGITAL INTEGRATED CIRCUIT SILICON MONOLITHIC

**TD62386AP, TD62386AF, TD62387AP  
TD62387AF, TD62388AP, TD62388AF**

**8 CH LOW INPUT ACTIVE DARLINGTON SINK DRIVER**

The TD62386AP, TD62386AF, TD62387AP, TD62387AF and TD62388AP, TD62388AF are non-inverting transistor arrays, which are comprised of eight NPN darlington output stages and PNP input stages. All units feature integral clamp diodes for switching inductive loads. These devices are Low Level input active drivers and are suitable for operations with TTL, 5V CMOS and 5V Microprocessor which have sink current output drivers. Applications include relay, hammer, lamp and LED driver.

**FEATURES**

- Output current (single output) 500mA (Max.)
- High sustaining voltage 50V (Min.)
- Output clamp diodes
- Low level active input
- Standard supply voltage
- Inputs compatible with TTL and 5V CMOS
- Package type-AP : DIP-20 pin
- Package type-AF : SOP-20 pin

TYPE	V <sub>IN</sub> (ON)
TD62386AP, TD62386AF	-20V~V <sub>CC</sub> -2.8V
TD62387AP, TD62387AF	0V~V <sub>CC</sub> -3.7V
TD62388AP, TD62388AF	

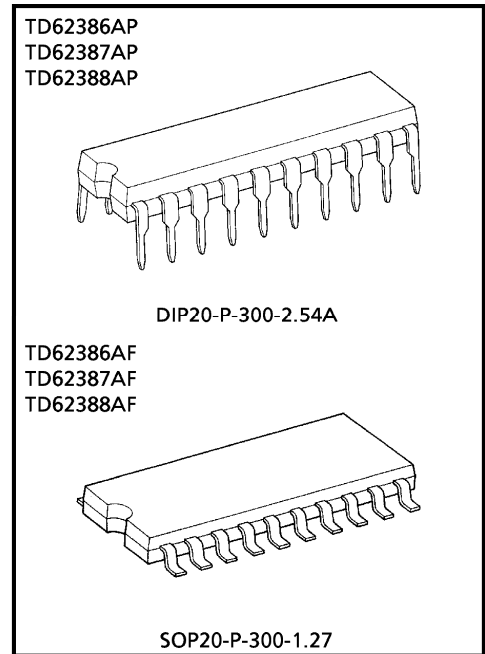

Weight  
 DIP20-P-300-2.54A : 2.25g (Typ.)  
 SOP20-P-300-1.27 : 0.25g (Typ.)

**PIN CONNECTION (TOP VIEW)**

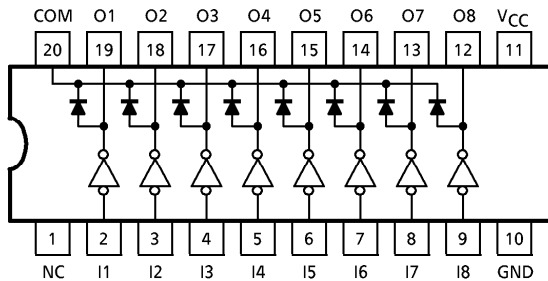

961001EBA2

- TOSHIBA is continually working to improve the quality and the reliability of its products. Nevertheless, semiconductor devices in general can malfunction or fail due to their inherent electrical sensitivity and vulnerability to physical stress. It is the responsibility of the buyer, when utilizing TOSHIBA products, to observe standards of safety, and to avoid situations in which a malfunction or failure of a TOSHIBA product could cause loss of human life, bodily injury or damage to property. In developing your designs, please ensure that TOSHIBA products are used within specified operating ranges as set forth in the most recent products specifications. Also, please keep in mind the precautions and conditions set forth in the TOSHIBA Semiconductor Reliability Handbook.
- The products described in this document are subject to foreign exchange and foreign trade control laws.
- The information contained herein is presented only as a guide for the applications of our products. No responsibility is assumed by TOSHIBA CORPORATION for any infringements of intellectual property or other rights of the third parties which may result from its use. No license is granted by implication or otherwise under any intellectual property or other rights of TOSHIBA CORPORATION or others.
- The information contained herein is subject to change without notice.

**SCHEMATICS (EACH DRIVER)**

TD62386AP, TD62386AF

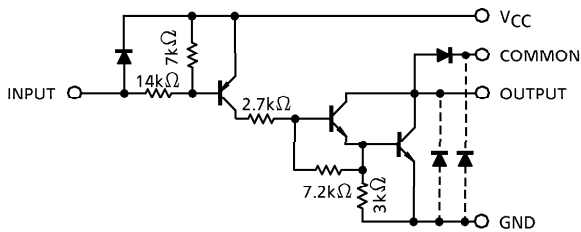

TD62387AP, TD62387AF

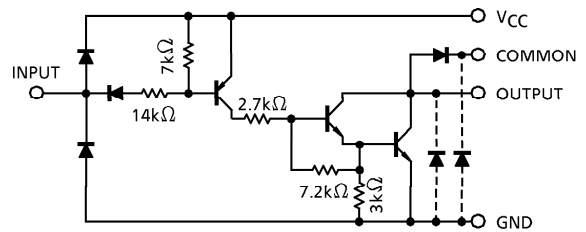

TD62388AP, TD62388AF

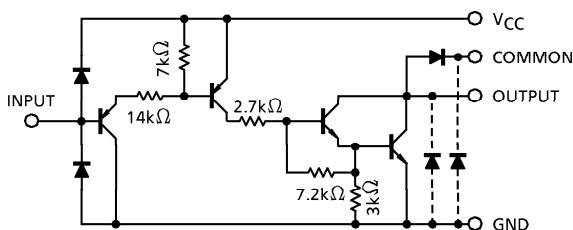

(Note) The output parasitic diode cannot be used as clamp diodes.

**MAXIMUM RATINGS**

CHARACTERISTIC		SYMBOL	RATING	UNIT
Supply Voltage		$V_{CC}$	-0.5~7.0	V
Output Sustaining Voltage	AP	$V_{CE(SUS)}$	-0.5~50	V
	AF		-0.5~35	
Output Current		$I_{OUT}$	500	mA / ch
Input Voltage		$V_{IN}$ (Note 1)	-22~ $V_{CC} + 0.5$	V
		$V_{IN}$ (Note 2)	-0.5~7	
Input Current		$I_{IN}$	-10	mA
Clamp Diode Reverse Voltage		$V_R$	50	V
Clamp Diode Forward Current		$I_F$	500	mA
Power Dissipation	AP	$P_D$ (Note 3)	1.38	W
	AF		1.0 (Note 4)	
Operating Temperature		$T_{opr}$	-40~85	°C
Storage Temperature		$T_{stg}$	-55~150	°C

(Note 1) TD62386AP, TD62386AF only

(Note 2) TD62387AP, TD62387AF, TD62388AP, TD62388AF only

(Note 3) Delated above 25°C in the proportion of 11.7mW/°C (AP-Type), 7.7mW/°C (F, AF-Type).

(Note 4) On PCB (50×50×1.6mm Cu 40% Glass Epoxy)

**RECOMMENDED OPERATING CONDITIONS (Ta = -40~85°C)**

CHARACTERISTIC		SYMBOL	CONDITION	MIN.	TYP.	MAX.	UNIT
Supply Voltage		V <sub>CC</sub>	—	4.5	5.0	5.5	V
Output Sustaining Voltage		V <sub>CE (SUS)</sub>	—	0	—	50	V
Output Current		I <sub>OUT</sub>	T <sub>pw</sub> = 25ms, Duty = 10%, 8 Circuits	0	—	270	mA / ch
Input Voltage	TD62386AP	V <sub>IN</sub>	—	-20	—	V <sub>CC</sub>	V
	TD62386AF						
	TD62387AP						
	TD62387AF						
	TD62388AP						
TD62388AF							
Clamp Diode Reverse Voltage		V <sub>R</sub>	—	—	50	V	
Clamp Diode Forward Current		I <sub>F</sub>	—	—	400	mA	
Power Dissipation	AP	P <sub>D</sub>	(Note 1)	—	—	0.52	W
	AF					0.4	

(Note 1) On Glass Epoxy PCB (50 × 50 × 1.6mm Cu 40%)

**ELECTRICAL CHARACTERISTICS (Ta = 25°C)**

CHARACTERISTIC		SYMBOL	TEST CIRCUIT	TEST CONDITION	MIN.	TYP.	MAX.	UNIT
Output Leakage Current		I <sub>CEX</sub>	1	V <sub>CC</sub> = 5.5V, I <sub>IN</sub> = 0 V <sub>OUT</sub> = 50V, Ta = 85°C	—	—	100	μA
Output Saturation Voltage		V <sub>CE (sat)</sub>	2	V <sub>CC</sub> = 4.5V, V <sub>IN</sub> = V <sub>IN (ON)</sub> MAX. I <sub>OUT</sub> = 350mA	—	1.4	2.0	V
Input Current	Output On	I <sub>IN (ON)</sub>	3	V <sub>CC</sub> = 5.5V, V <sub>IN</sub> = 0.4V	—	-0.32	-0.45	mA
	Output Off	I <sub>IN (OFF)</sub>	4	V <sub>CC</sub> = 5.5V, V <sub>IN</sub> = -20V	—	—	-2.6	
Input Voltage (Output On)	TD62386AP	V <sub>IN (ON)</sub>	5	—	—	—	V <sub>CC</sub> - 2.8	V
	TD62386AF							
	TD62387AP							
	TD62387AF							
	TD62388AP							
TD62388AF								
Clamp Diode Reverse Current		I <sub>R</sub>	6	V <sub>R</sub> = 50V, Ta = 25°C	—	—	50	μA
				V <sub>R</sub> = 50V, Ta = 85°C	—	—	100	
Clamp Diode Forward Voltage		V <sub>F</sub>	7	I <sub>F</sub> = 350mA	—	—	2.0	V
				I <sub>F</sub> = 280mA	—	—	1.8	
Supply Current	I <sub>CC (ON)</sub>	8	8	V <sub>CC</sub> = 5.5V, V <sub>IN</sub> = 0	—	17	22	mA
	I <sub>CC (OFF)</sub>			V <sub>CC</sub> = 5.5V, V <sub>IN</sub> = V <sub>CC</sub>	—	—	100	
Turn-On Delay	t <sub>ON</sub>	9	9	V <sub>CC</sub> = 5V, V <sub>OUT</sub> = 50V R <sub>L</sub> = 125Ω, C <sub>L</sub> = 15pF	—	0.1	—	μs
Turn-Off Delay	t <sub>OFF</sub>				—	3	—	

**TEST CIRCUIT**

1.  $I_{CEX}$

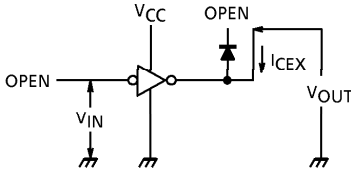

2.  $V_{CE(sat)}$

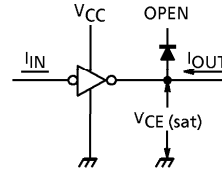

3.  $I_{IN(ON)}$

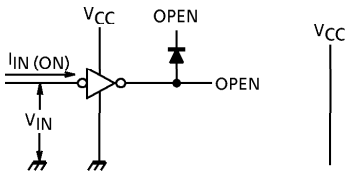

4.  $I_{IN(OFF)}$

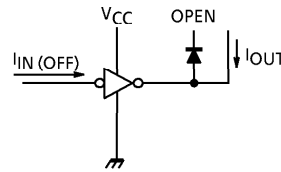

5.  $V_{IN(ON)}$

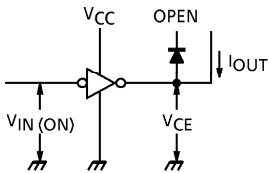

6.  $I_R$

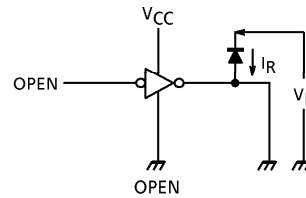

7.  $V_F$

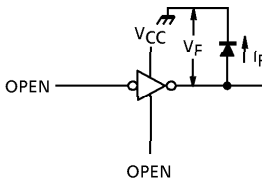

8.  $I_{CC}$

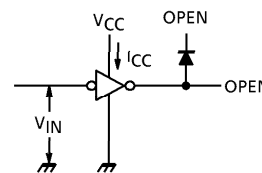

9.  $t_{ON}, t_{OFF}$

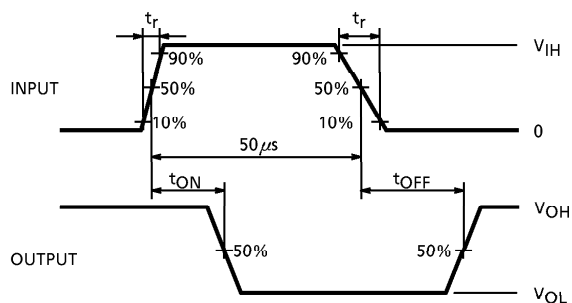
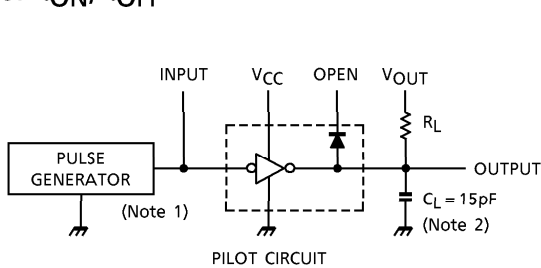

- (Note 1) Pulse Width  $50\mu s$ , Duty Cycle 10%  
Output Impedance  $50\Omega$ ,  $t_r \leq 5ns$ ,  $t_f \geq 10ns$
- (Note 2)  $C_L$  includes probe and jig capacitance

**PRECAUTIONS for USING**

Utmost care is necessary in the design of the output line,  $V_{CC}$ , COMMON and GND line since IC may be destroyed due to short-circuit between outputs, air contamination fault, or fault by improper grounding.

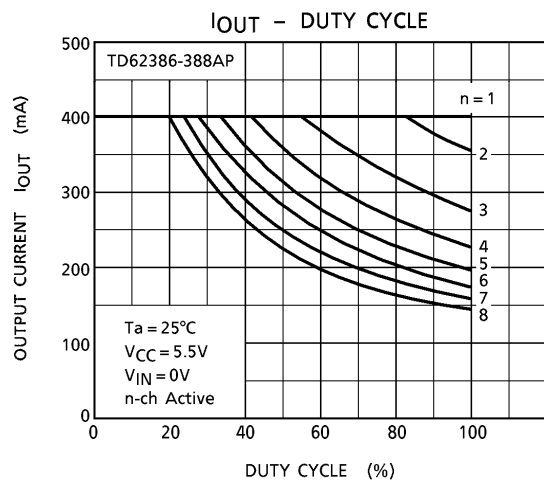
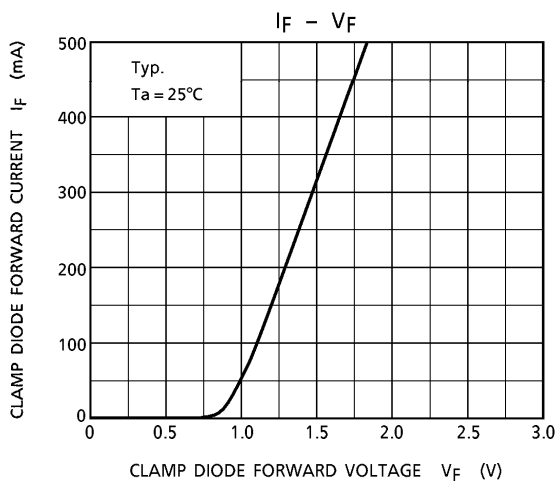
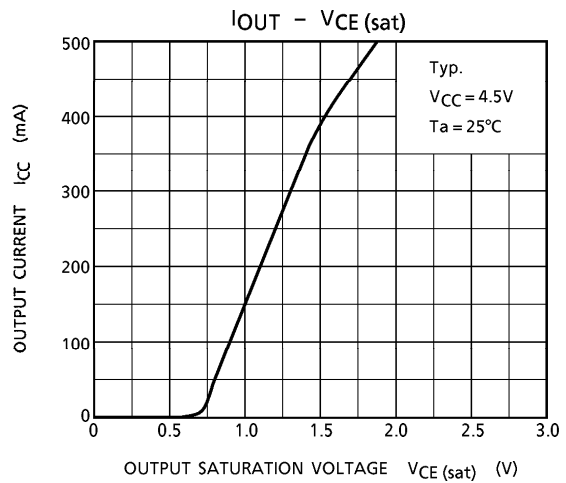
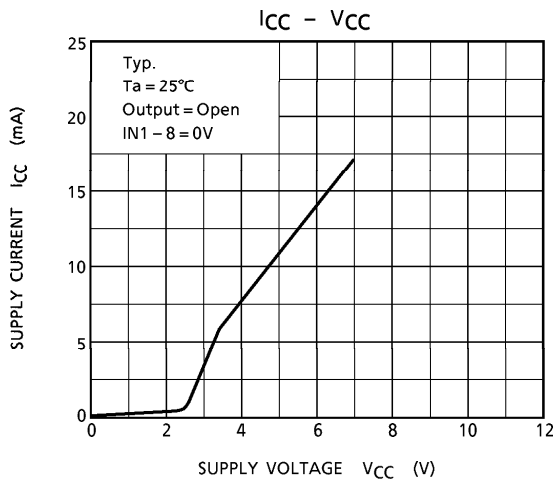
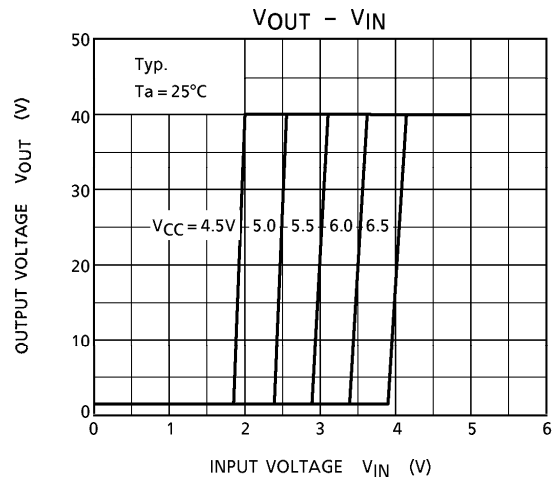
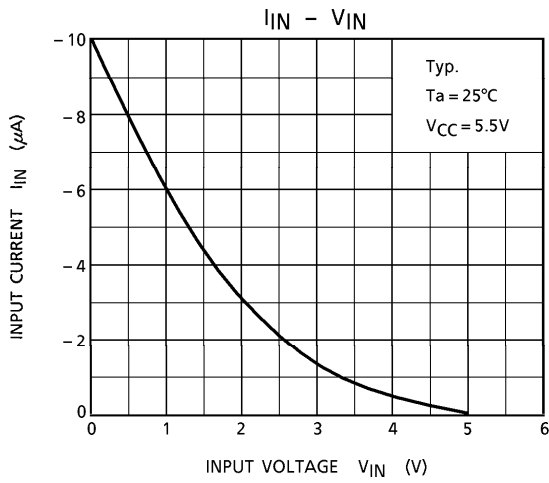

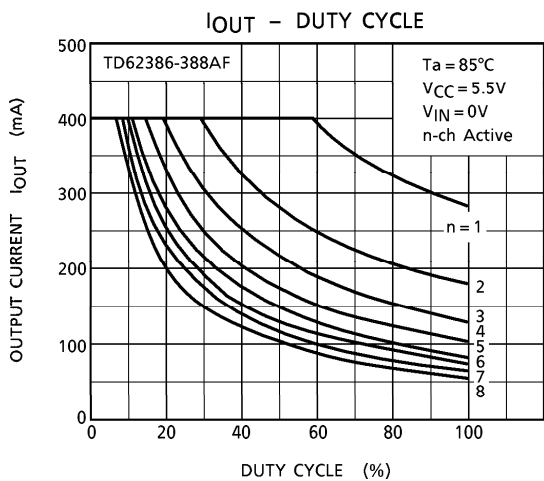
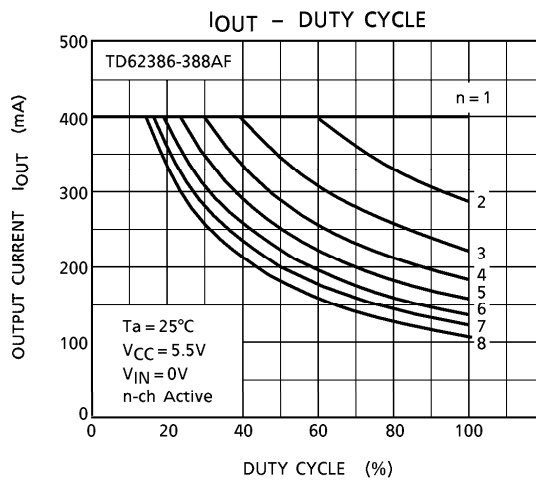
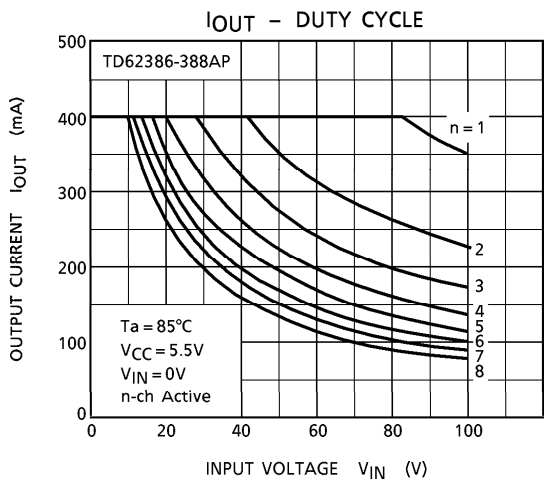

**OUTLINE DRAWING**  
DIP20-P-300-2.54A

Unit : mm

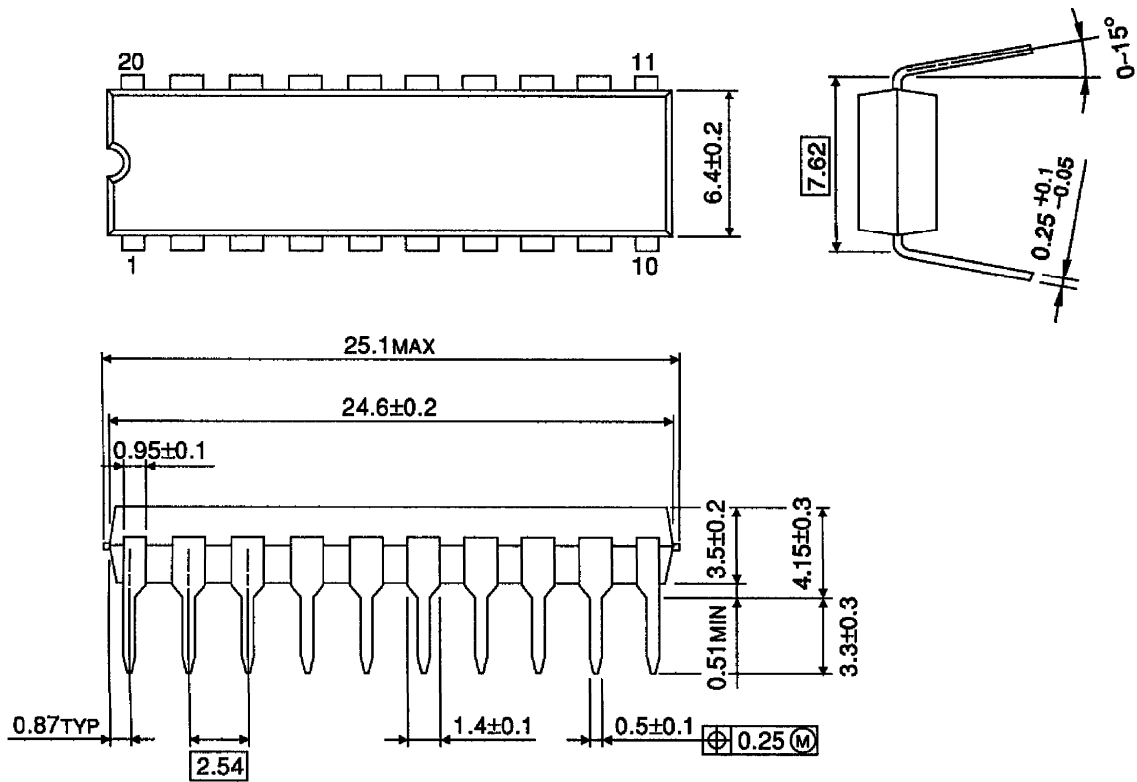

Weight : 2.25g (Typ.)

**OUTLINE DRAWING**  
SOP20-P-300-1.27

Unit : mm

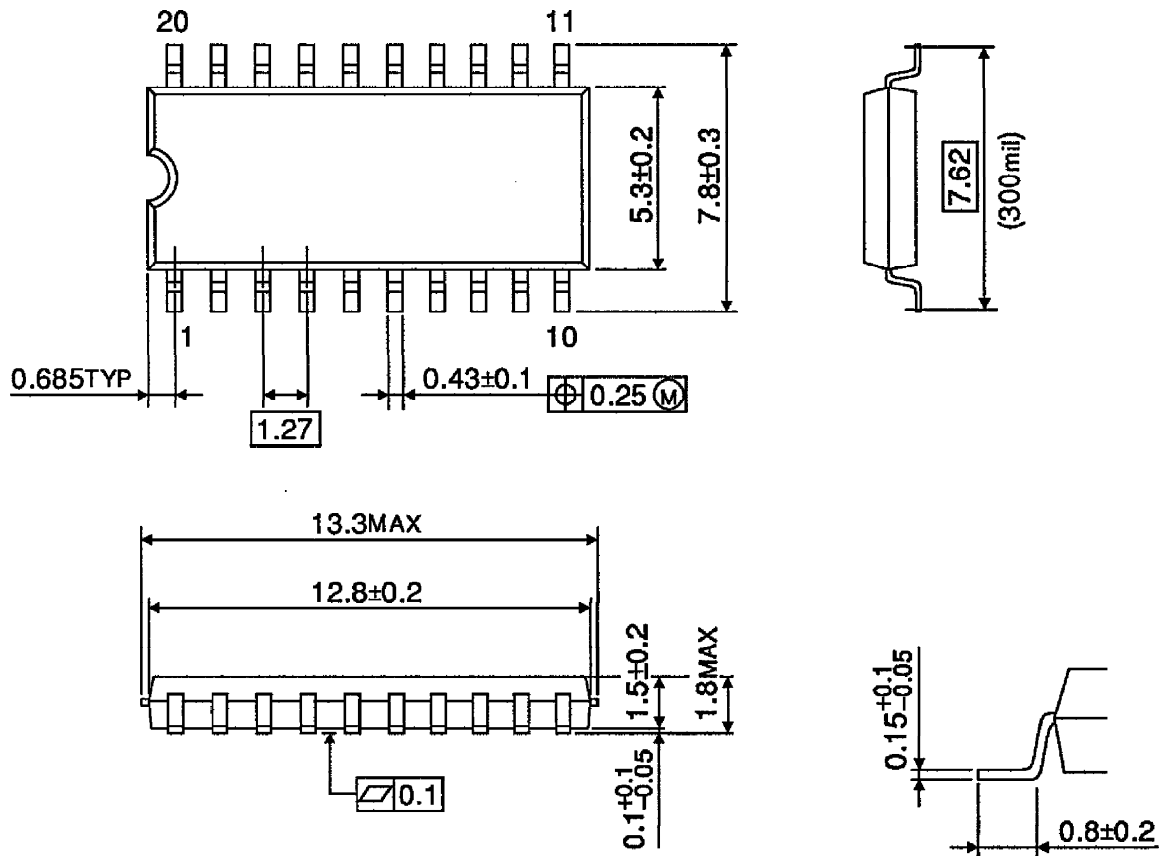

Weight : 0.25g (Typ.)