



LA1060

Antenna Switching Diversity Circuit for Car-Use FM Tuners

Functions

- Noise amp, noise AGC circuit, noise density circuit.
- Antenna switching trigger output circuit.
- Antenna switching T flip-flop circuit.
- Antenna holding function to be used at weak input signal reception mode, forced antenna holding function.

Features

- "Count system"-used, reliable detection of multipath distortion.
- One-tuner type diversity system allowing cost reduction of sets.
- The output to hold the antenna at the weak input signal mode and the output (antenna switching trigger output) to indicate that the antenna switching frequency is high are delivered at the same pin, allowing a wide variety of applications according to the design concept of set.

Package Dimensions

unit: mm

3017B-SIP9

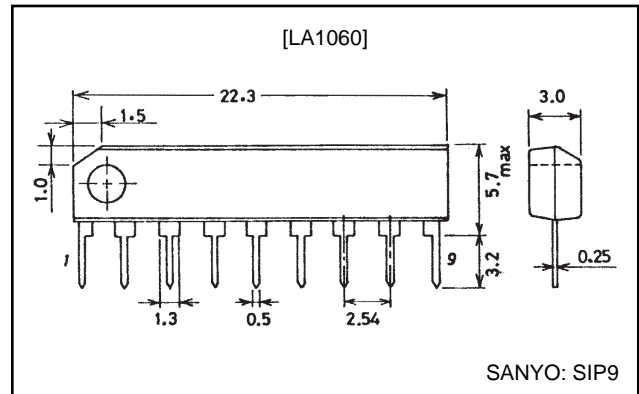

Specifications

Maximum Ratings at Ta=25°C

Parameter	Symbol	Conditions	Ratings	Unit
Maximum supply voltage	V _{CC} max		16	V
Maximum flow-out	I ₄ max		1	mA
	I ₆ max		2	mA
	I ₇ max		10	mA
	I ₈ max		10	mA
Maximum flow-in current	I ₆ max		10	mA
Allowable power dissipation	P _d max	Ta ≤ 75°C	200	mW
Operating temperature	T _{opr}		-20 to +75	°C
Storage temperature	T _{stg}		-40 to +125	°C

Operating Conditions at Ta=25°C

Parameter	Symbol	Conditions	Ratings	Unit
Recommended supply voltage	V _{CC}		8	V
Operating voltage range	V _{CC} op		6.5 to 15	V

LA1060

Electrical Characteristics at $T_a=25^\circ\text{C}$, $V_{CC}=8.0\text{V}$, $f=100\text{kHz}$ sine wave

Parameter	Symbol	Conditions	Ratings			Unit
			min	typ	max	
Current drain	I_{CC}	No input, not including pins 7, 8 current	3.8	4.9	6.0	mA
Pin 7 high voltage	V_{7H}	Pin 7-GND resistance= $1\text{k}\Omega$	5.0	6.0	7.0	V
Pin 8 high voltage	V_{8H}	Pin 8-GND resistance= $1\text{k}\Omega$	5.0	6.0	7.0	V
Noise amp gain	V_{G1}	Input= 3mV_{rms} *1	33	36	39	dB
	V_{G2}	Input= $100\text{mV}_{\text{rms}}$ *1	10	13	16	dB
Noise detection sensitivity	NDS	Noise AGC=OFF Input signal level at which the output at pins 7, 8 starts to be inverted *2	9	12	15	mVrms
Number of noise counts NCN		Input= 30mV_{rms} Number of sine waves which causes the output at pins 7, 8 to be inverted *2		10		
Gate time	t_G	Noise AGC=OFF Repetitive period of pin 4 waveform	100	120	140	μs
Pin 6 voltage	V_6	Input= $100\text{mV}_{\text{rms}}$ *3	1.6	2.0	2.5	V
Antenna holding	HLD	Input= $100\text{mV}_{\text{rms}}$, noise AGC=OFF Pin 8 output voltage *4	5.0	6.0	7.0	V

Note

*1 : S1=OFF S2=OFF S3=ON S4=OFF S5=OFF

*2 : S1=OFF S2=ON S3=OFF S4=ON S5=OFF

*3 : S1=OFF S2=OFF S3=OFF S4=ON S5=OFF

*4 : S1=OFF S2=ON S3=OFF S4=ON S5=ON

Pin Assignment

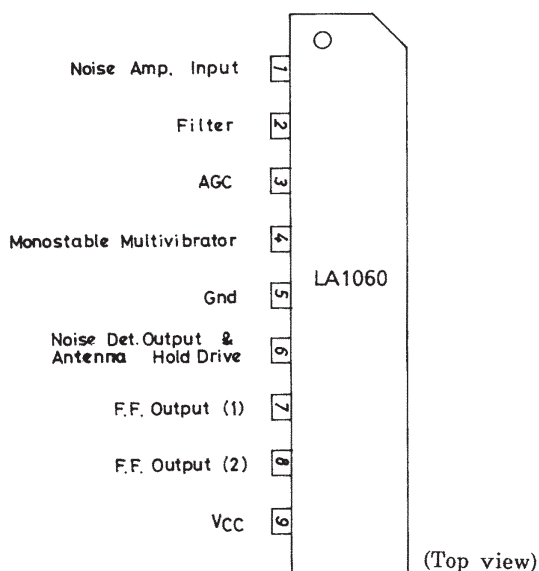

LA1060

AC Characteristics Test Circuit Diagram

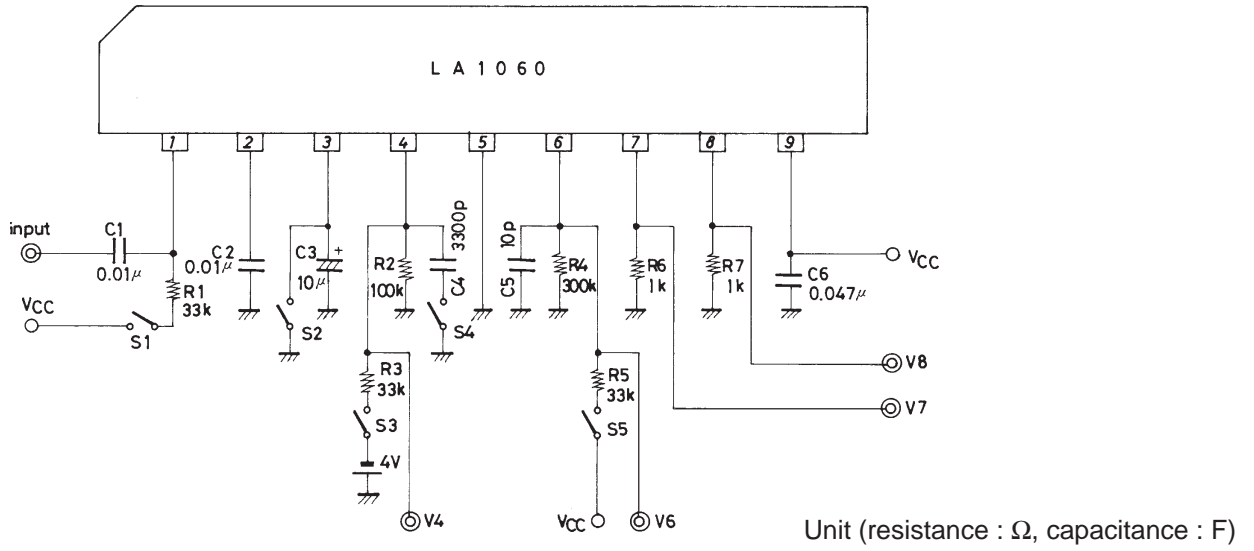

Block Diagram

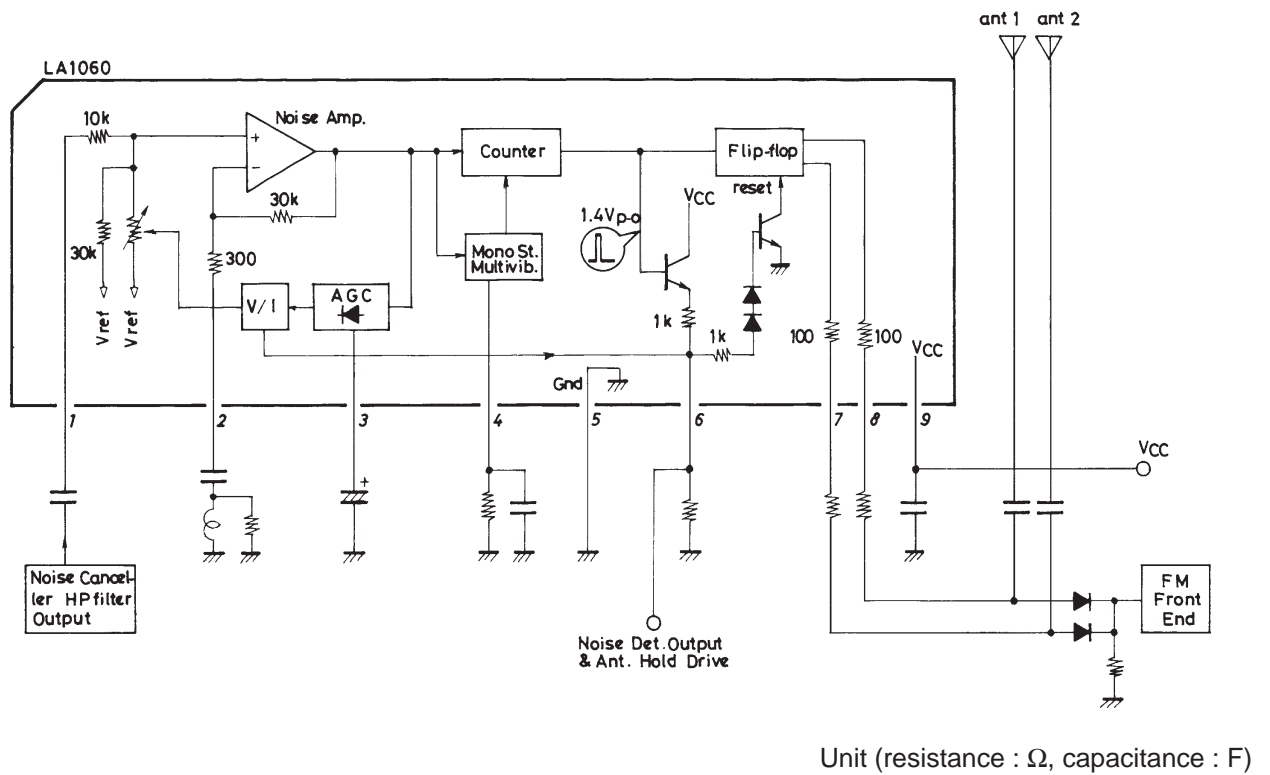

LA1060

Sample Application Circuit 1

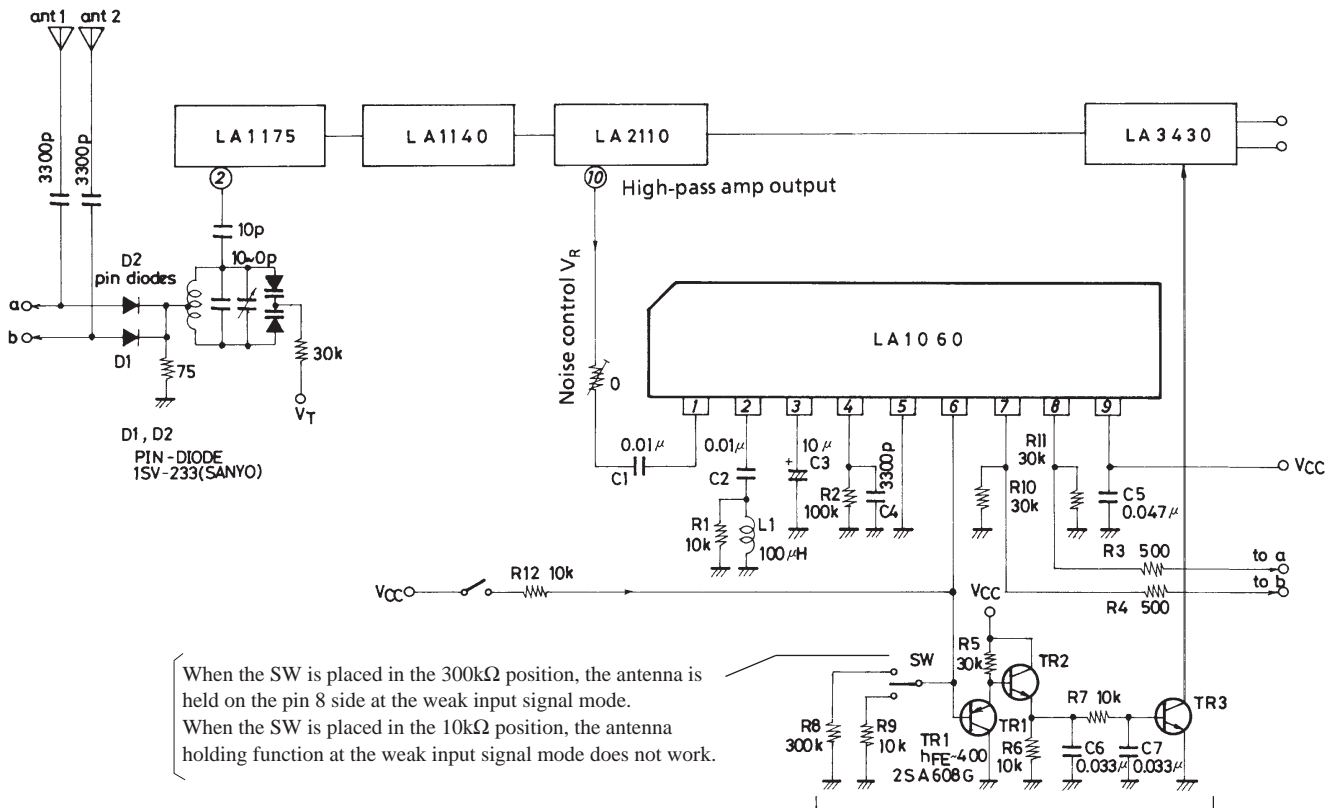

Unit (resistance : Ω, capacitance : F)

Circuit to cause the separation control at the MPX stage to be entered into the forced monaural mode when the antenna switching frequency is high. The antenna switching trigger pulse at pin 6 is peak-held, integrated, and attacks the separation control pin.

Component Placement Diagram

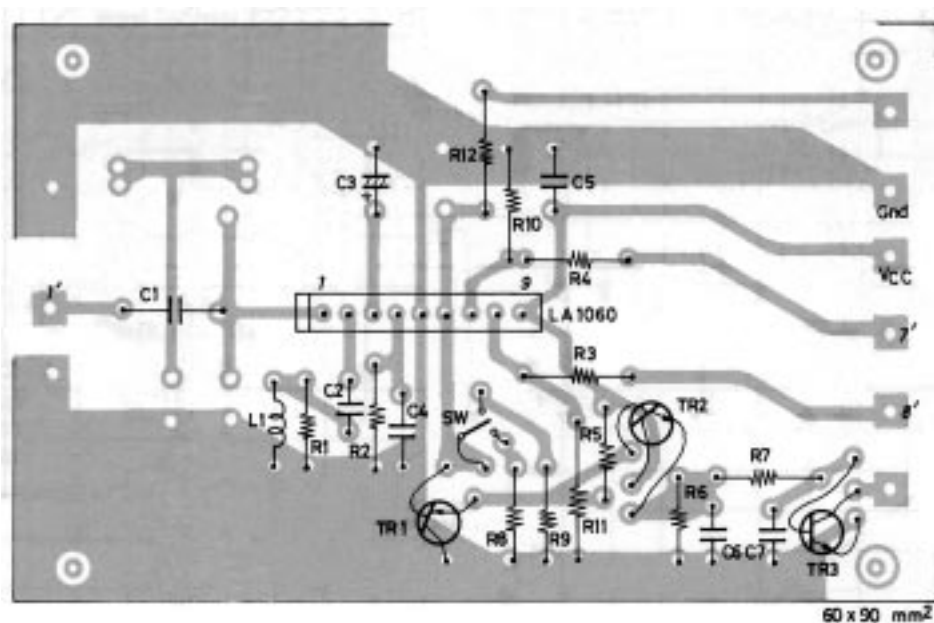

R1, Q1, R5, R10, R11 are connected to the Cu-foiled side.
(Because no holes are made.)

Noise Detection Method of the LA1060

(1) "Count system"-used noise detection

- The LA 1060 is so designed as to count the noise components of 100kHz or greater in the IF output to detect the multipath distortion.
- Car-use FM tuners are always affected by noises shown below.

(1) Ignition noise

(2) Noise attendant on modulation.

The actual modulation signal is not a continuous wave, but an intermittent signal. When the modulation signal rises in a burst fashion, the high frequency noise components are detected in the FM demodulation output (because in a burst fashion, overmodulation may occur or the signal rise characteristic may include the high frequency components.)

(3) Random noise

The random noise at the weak input signal mode includes some noise components whose peak value is two to three times as high as the average noise level.

- As a result of checking the above-mentioned noises, we found that the noise of more than a given level being present within a given period of time (example : within 100 μ s) is included in the FM demodulation output of car-use FM tuners at less than a given density only.
- By contrast, when the multipath distortion or skip noise occurs, the continuous noise components occur and the above-mentioned noise density increases.
- Therefore, by using "count system" to count the noise density, the detection of multipath distortion and skip noise detection can be performed with less malfunction.

(2) Noise detection time

- It is desirable that the noise detection time is faster (Note 1). However, the noise detection time (noise count time) of the LA1060 is approximately 100 μ s so that the above-mentioned three types of noise cause no malfunction to occur.

(Note 1) • If the period of noise duration is 20 μ s or less, the noise is hardly offensive to the ears. If the period of noise duration is 50 to 200 μ s, the noise is heard as a sound "buzz", but a single noise is hardly offensive to the ears.

- If the period of noise duration is 500 μ s or more, the noise is heard as a sound "zah" which is offensive to the ears.

Sample Application Circuit 2

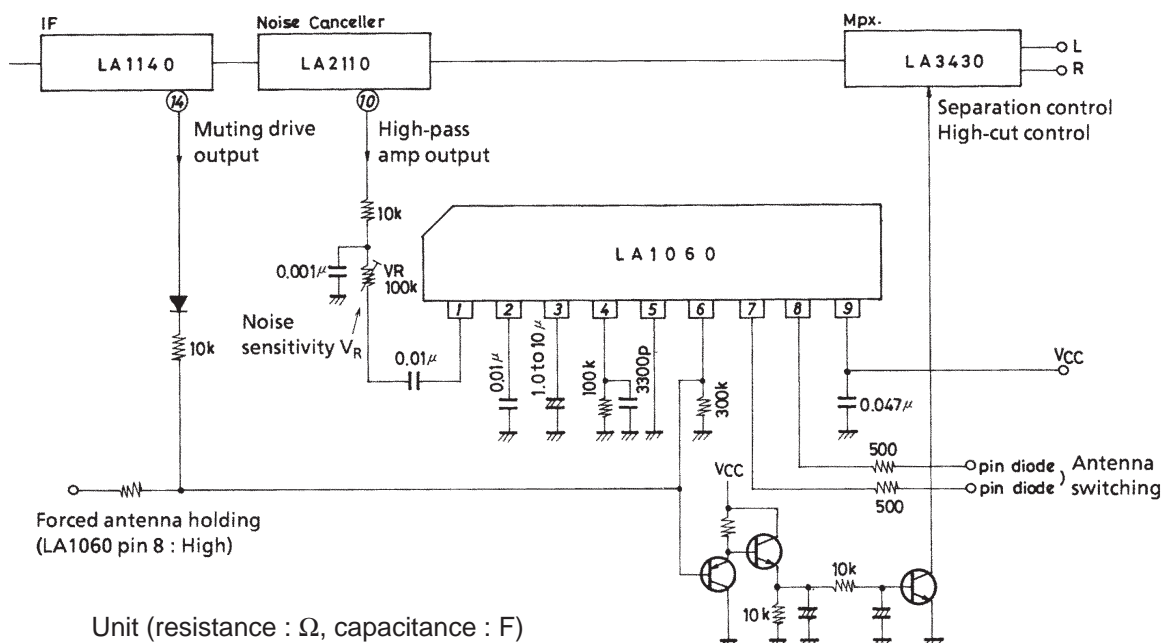

Sample Application Circuit 3

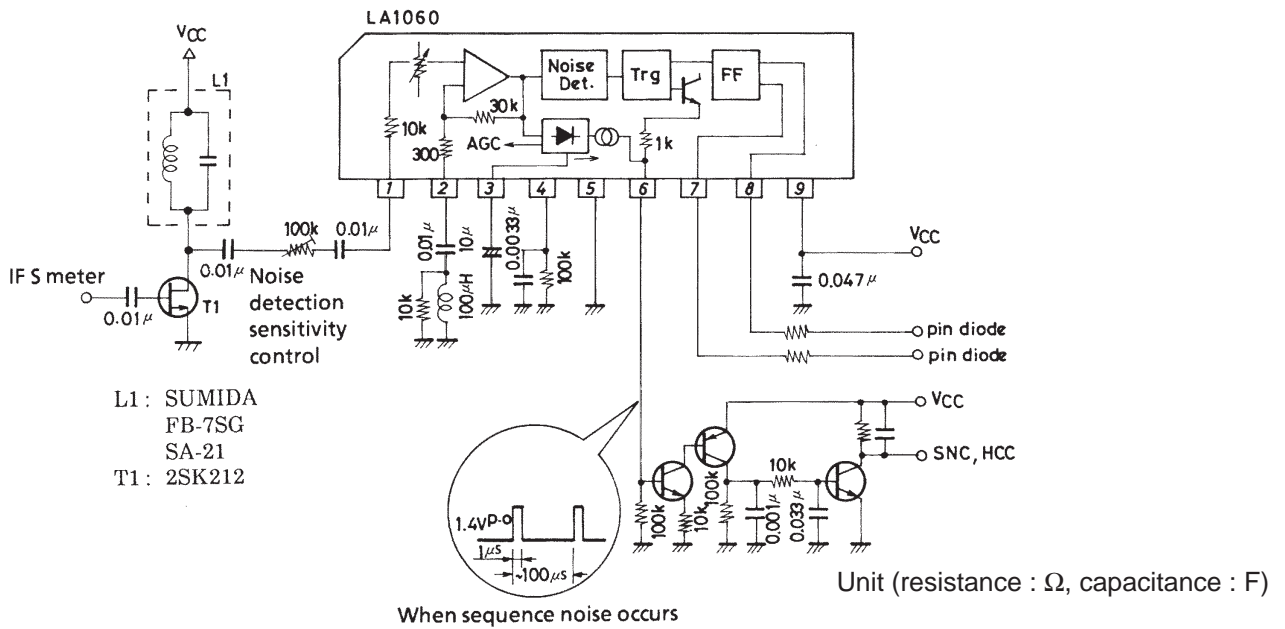

L1 : SUMIDA
FB-7SG
SA-21
T1 : 2SK212

When sequence noise occurs

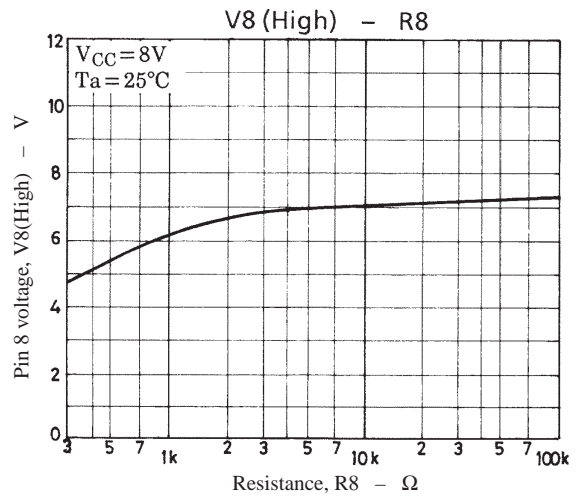
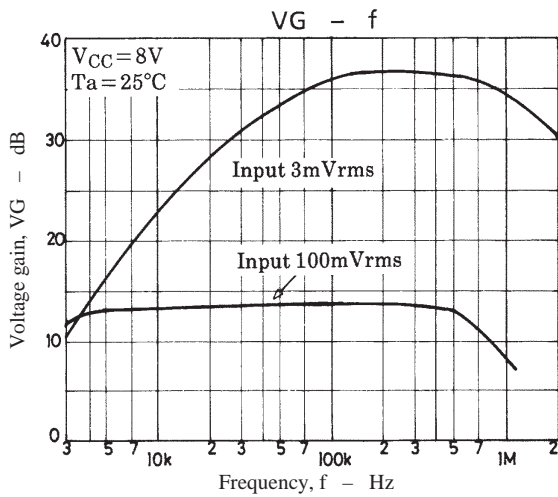
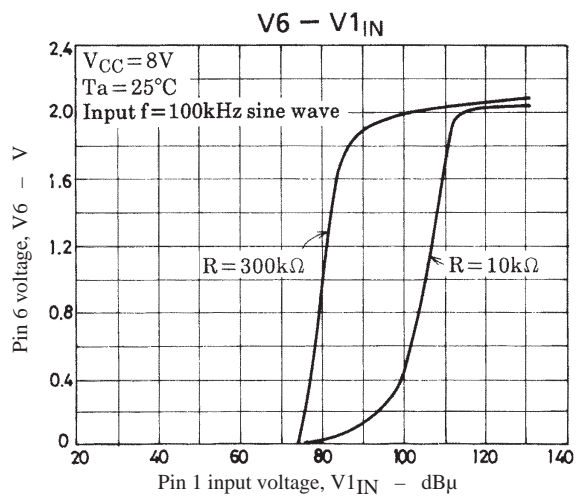
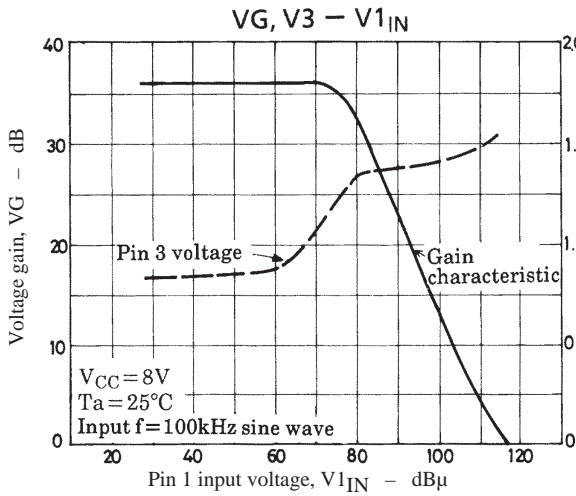

LA1060

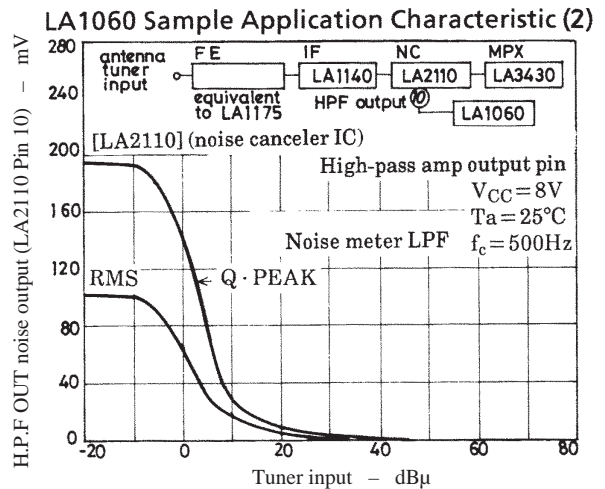
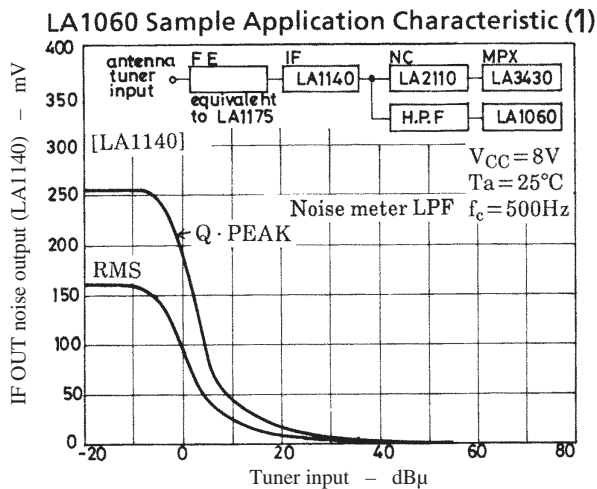
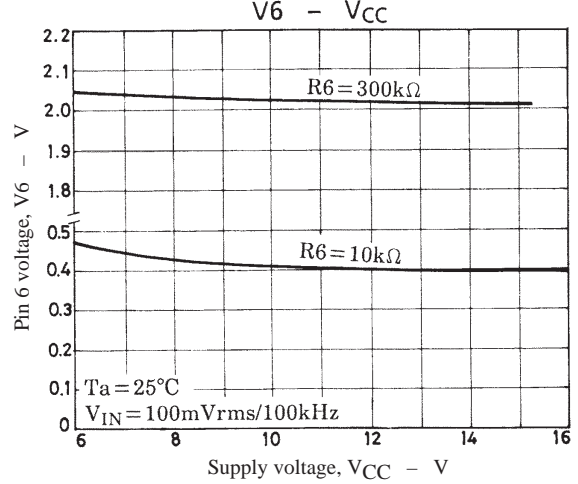
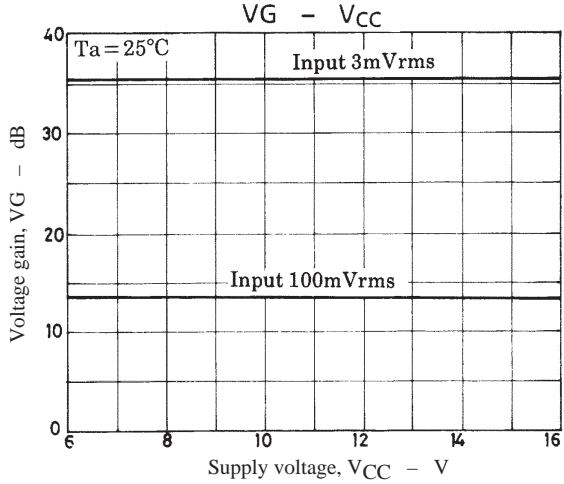
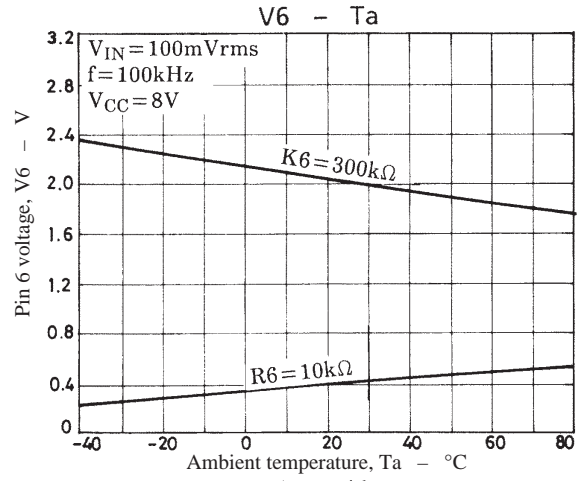
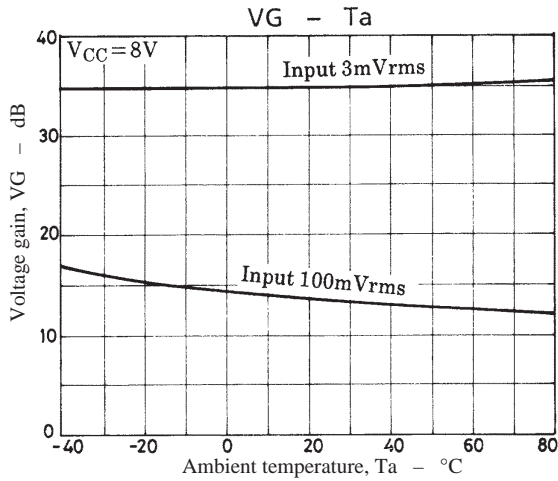
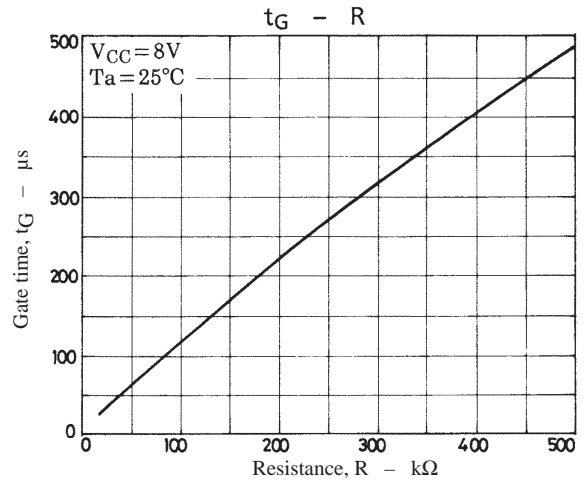
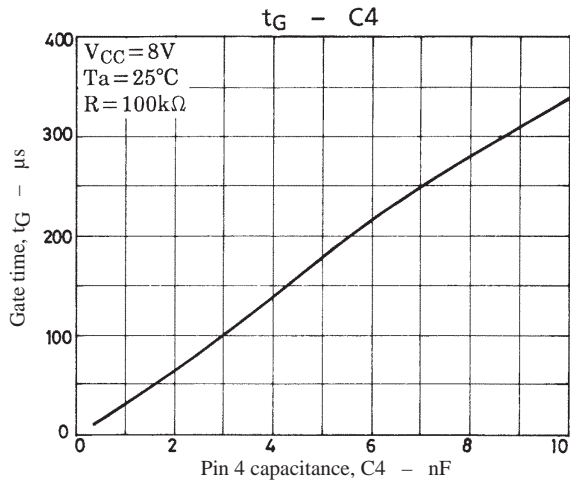

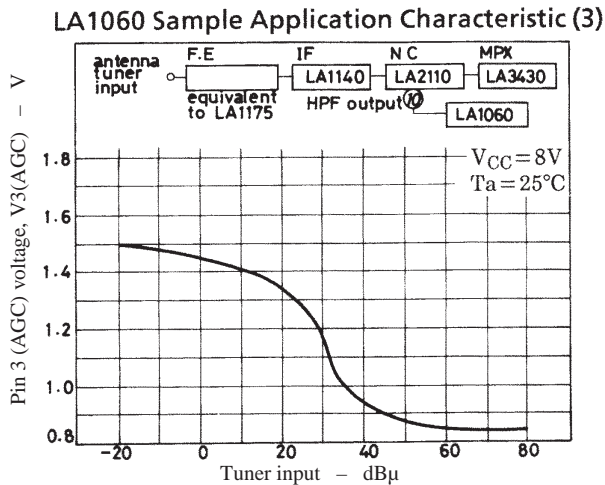

Note for Application

1. Noise sensitivity setting

When the LA1060 is used in conjunction with the LA2110, it is unnecessary to adjust the sensitivity. However, if any malfunction occurs, increase the noise sensitivity control VR from 0 Ω to 50k Ω —100k Ω to decrease the input noise level.

2. Gate time setting

The recommended gate time is 120 μs . If any malfunction occurs, shorten the gate time, and less malfunction will result. If the gate time is made longer, the multipath distortion detection sensitivity is increased. The gate time can be set by varying the value of the capacitor or resistor connected to pin 4.

3. Antenna holding function

- To hold the antenna at the weak input signal mode, set the value of the resistor connected to pin 6 to approximately 300k Ω . In this case, the pin 8 output is brought to High level. The antenna input level at which the antenna is held can be adjusted by varying the value (300k Ω) of the resistor.
- To switch the antenna even at the weak input signal mode, set the value of the resistor connected to pin 6 to approximately 10k Ω .

4. Forced antenna holding

Set the pin 6 voltage to 2.5V or greater (example : connect to V_{CC} through 10k Ω), and the antenna can be held on the pin 8 side,

■ No products described or contained herein are intended for use in surgical implants, life-support systems, aerospace equipment, nuclear power control systems, vehicles, disaster/crime-prevention equipment and the like, the failure of which may directly or indirectly cause injury, death or property loss.

■ Anyone purchasing any products described or contained herein for an above-mentioned use shall:

- Accept full responsibility and indemnify and defend SANYO ELECTRIC CO., LTD., its affiliates, subsidiaries and distributors and all their officers and employees, jointly and severally, against any and all claims and litigation and all damages, cost and expenses associated with such use:
- Not impose any responsibility for any fault or negligence which may be cited in any such claim or litigation on SANYO ELECTRIC CO., LTD., its affiliates, subsidiaries and distributors or any of their officers and employees jointly or severally.

■ Information (including circuit diagrams and circuit parameters) herein is for example only; it is not guaranteed for volume production. SANYO believes information herein is accurate and reliable, but no guarantees are made or implied regarding its use or any infringements of intellectual property rights or other rights of third parties.

This catalog provides information as of August, 1997. Specifications and information herein are subject to change without notice.