



# Miniature, 300MHz, Single-Supply, Rail-to-Rail Op Amps with Enable

## General Description

The MAX4212/MAX4213 single, MAX4216 dual, MAX4218 triple, and MAX4220 quad op amps are unity-gain-stable devices that combine high-speed performance with rail-to-rail outputs. The MAX4213/MAX4218 have a disable feature that reduces power-supply current to 400 $\mu$ A and places the outputs into a high-impedance state. These devices operate from a +3.3V to +10V single supply or from  $\pm 1.65$ V to  $\pm 5$ V dual supplies. The common-mode input voltage range extends beyond the negative power-supply rail (ground in single-supply applications).

These devices require only 5.5mA of quiescent supply current while achieving a 300MHz -3dB bandwidth and a 600V/ $\mu$ s slew rate. Input voltage noise is only 10nV/ $\sqrt{\text{Hz}}$  and input current noise is only 1.3pA/ $\sqrt{\text{Hz}}$  for either the inverting or noninverting input. These parts are an excellent solution in low-power/low-voltage systems that require wide bandwidth, such as video, communications, and instrumentation. In addition, when disabled, their high output impedance makes them ideal for multiplexing applications.

The MAX4212 comes in a miniature 5-pin SOT23 package, while the MAX4213/MAX4216 come in 8-pin  $\mu$ MAX and SO packages. The MAX4218/MAX4220 are available in a space-saving 16-pin QSOP, as well as a 14-pin SO.

## Applications

Battery-Powered Instruments  
Video Line Driver  
Analog-to-Digital Converter Interface  
CCD Imaging Systems  
Video Routing and Switching Systems

## Typical Operating Circuit

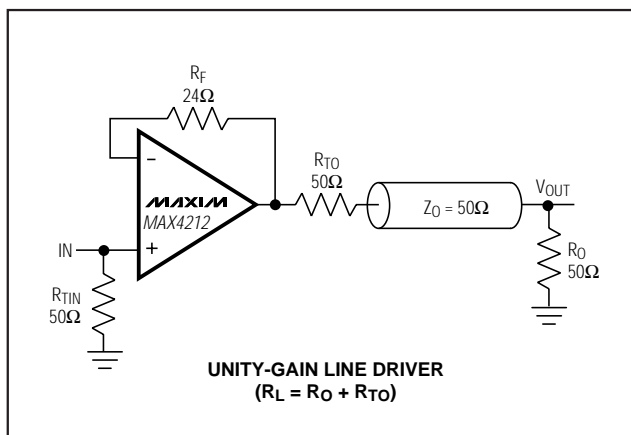

## Features

- ◆ **High Speed:**
  - 300MHz -3dB Bandwidth (MAX4212/13)
  - 200MHz -3dB Bandwidth (MAX4216/18/20)
  - 50MHz 0.1dB Gain Flatness (MAX4212/13)
  - 600V/ $\mu$ s Slew Rate
- ◆ **Single 3.3V/5.0V Operation**
- ◆ **Rail-to-Rail Outputs**
- ◆ **Input Common-Mode Range Extends Beyond VEE**
- ◆ **Low Differential Gain/Phase: 0.02%/0.02°**
- ◆ **Low Distortion at 5MHz:**
  - 78dBc SFDR
  - 75dB Total Harmonic Distortion
- ◆ **High Output Drive:  $\pm 100$ mA**
- ◆ **400 $\mu$ A Shutdown Capability (MAX4213/18)**
- ◆ **High Output Impedance in Off State (MAX4213/18)**
- ◆ **Space-Saving SOT23-5,  $\mu$ MAX, or QSOP Packages**

## Ordering Information

PART	TEMP. RANGE	PIN-PACKAGE	SOT TOP MARK
MAX4212EUK	-40°C to +85°C	5 SOT23-5	ABAF
MAX4213ESA	-40°C to +85°C	8 SO	—
MAX4213EUA	-40°C to +85°C	8 $\mu$ MAX	—

Ordering Information continued at end of data sheet.

## Pin Configuration

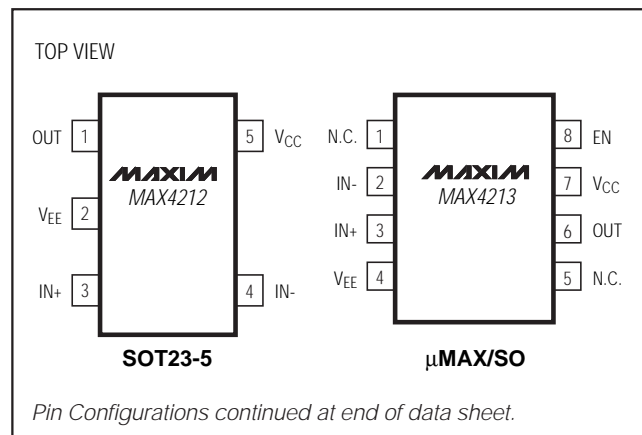

# Miniature, 300MHz, Single-Supply, Rail-to-Rail Op Amps with Enable

## ABSOLUTE MAXIMUM RATINGS

Supply Voltage (VCC to VEE).....	+12V	8-Pin $\mu$ MAX (derate 4.5mW/°C above +70°C) .....	221mW
IN <sub>-</sub> , IN <sub>+</sub> , OUT <sub>-</sub> , EN <sub>-</sub> .....	(VEE - 0.3V) to (VCC + 0.3V)	14-Pin SO (derate 8.3mW/°C above +70°C) .....	667mW
Output Short-Circuit Duration to VCC or VEE .....	Continuous	16-Pin QSOP (derate 8.3mW/°C above +70°C) .....	667mW
Continuous Power Dissipation (TA = +70°C)		Operating Temperature Range .....	-40°C to +85°C
5-Pin SOT23 (derate 7.1mW/°C above +70°C) .....	571mW	Storage Temperature Range .....	-65°C to +150°C
8-Pin SO (derate 5.9mW/°C above +70°C) .....	471mW	Lead Temperature (soldering, 10sec) .....	+300°C

Stresses beyond those listed under "Absolute Maximum Ratings" may cause permanent damage to the device. These are stress ratings only, and functional operation of the device at these or at any other conditions beyond those indicated in the operational sections of the specifications is not implied. Exposure to absolute maximum rating conditions for extended periods may affect device reliability.

## DC ELECTRICAL CHARACTERISTICS

(VCC = +5V, VEE = 0V, EN<sub>-</sub> = +5V, RL = 2k $\Omega$  to VCC / 2, VOUT = VCC / 2, TA = TMIN to TMAX, unless otherwise noted. Typical values are at TA = +25°C.)

PARAMETER	SYMBOL	CONDITIONS	MIN	TYP	MAX	UNITS
Input Common-Mode Voltage Range	V <sub>CM</sub>	Guaranteed by CMRR test	V <sub>EE</sub> - 0.20		V <sub>CC</sub> - 2.25	V
Input Offset Voltage (Note 1)	V <sub>OS</sub>	MAX4212EUK, MAX421_EUA		4	12	mV
		MAX42_ _ES_, MAX42_ _EEE		4	9	
Input Offset Voltage Temperature Coefficient	TC <sub>VOS</sub>			8		$\mu$ V/°C
Input Offset Voltage Matching		Any channels for MAX4216/MAX4218/MAX4220		$\pm$ 1		mV
Input Bias Current	I <sub>B</sub>	(Note 1)		5.4	9.0	$\mu$ A
Input Offset Current	I <sub>OS</sub>	(Note 1)		0.1	1.0	$\mu$ A
Input Resistance	R <sub>IN</sub>	Differential mode (-1V $\leq$ V <sub>IN</sub> $\leq$ +1V)		70		k $\Omega$
		Common mode (-0.2V $\leq$ V <sub>CM</sub> $\leq$ +2.75V)		3		M $\Omega$
Common-Mode Rejection Ratio	CMRR	(V <sub>EE</sub> - 0.2V) $\leq$ V <sub>CM</sub> $\leq$ (V <sub>CC</sub> - 2.25V)	70	100		dB
Open-Loop Gain (Note 1)	A <sub>VOL</sub>	0.25V $\leq$ V <sub>OUT</sub> $\leq$ 4.75V, R <sub>L</sub> = 2k $\Omega$	55	61		dB
		0.5V $\leq$ V <sub>OUT</sub> $\leq$ 4.5V, R <sub>L</sub> = 150 $\Omega$	52	59		
		1.0V $\leq$ V <sub>OUT</sub> $\leq$ 4V, R <sub>L</sub> = 50 $\Omega$		57		
Output Voltage Swing	V <sub>OUT</sub>	R <sub>L</sub> = 10k $\Omega$	V <sub>CC</sub> - V <sub>OH</sub>	0.05		V
			V <sub>OL</sub> - V <sub>EE</sub>	0.05		
		R <sub>L</sub> = 2k $\Omega$	V <sub>CC</sub> - V <sub>OH</sub>	0.06	0.20	
			V <sub>OL</sub> - V <sub>EE</sub>	0.06	0.20	
		R <sub>L</sub> = 150 $\Omega$	V <sub>CC</sub> - V <sub>OH</sub>	0.30	0.50	
			V <sub>OL</sub> - V <sub>EE</sub>	0.30	0.50	
R <sub>L</sub> = 50 $\Omega$	V <sub>CC</sub> - V <sub>OH</sub>	0.70				
	V <sub>OL</sub> - V <sub>EE</sub>	0.60				

# Miniature, 300MHz, Single-Supply, Rail-to-Rail Op Amps with Enable

## DC ELECTRICAL CHARACTERISTICS (continued)

(V<sub>CC</sub> = +5V, V<sub>EE</sub> = 0V, EN<sub>-</sub> = +5V, R<sub>L</sub> = 2kΩ to V<sub>CC</sub> / 2, V<sub>OUT</sub> = V<sub>CC</sub> / 2, T<sub>A</sub> = T<sub>MIN</sub> to T<sub>MAX</sub>, unless otherwise noted. Typical values are at T<sub>A</sub> = +25°C.)

PARAMETER	SYMBOL	CONDITIONS	MIN	TYP	MAX	UNITS
Output Current	I <sub>OUT</sub>	R <sub>L</sub> = 20Ω to V <sub>CC</sub> or V <sub>EE</sub>	±100	±120		mA
Output Short-Circuit Current	I <sub>SC</sub>	Sinking or sourcing		±150		mA
Open-Loop Output Resistance	R <sub>OUT</sub>			8		Ω
Power-Supply Rejection Ratio (Note 2)	PSRR	V <sub>CC</sub> = 5V, V <sub>EE</sub> = 0V, V <sub>CM</sub> = +2.0V	52	57		dB
		V <sub>CC</sub> = 5V, V <sub>EE</sub> = -5V, V <sub>CM</sub> = 0V	60	66		
		V <sub>CC</sub> = 3.3V, V <sub>EE</sub> = 0V, V <sub>CM</sub> = +0.90V		45		
Operating Supply-Voltage Range	V <sub>S</sub>	V <sub>CC</sub> to V <sub>EE</sub>	3.15		11.0	V
Disabled Output Resistance	R <sub>OUT (OFF)</sub>	EN <sub>-</sub> = 0V, 0V ≤ V <sub>OUT</sub> ≤ 5V (Note 3)	20	35		kΩ
EN <sub>-</sub> Logic-Low Threshold	V <sub>IL</sub>				V <sub>CC</sub> - 2.6	V
EN <sub>-</sub> Logic-High Threshold	V <sub>IH</sub>			V <sub>CC</sub> - 1.6		V
EN <sub>-</sub> Logic Input Low Current	I <sub>IL</sub>	(V <sub>EE</sub> + 0.2V) ≤ EN <sub>-</sub> ≤ V <sub>CC</sub>		0.5		μA
		EN <sub>-</sub> = 0V		200	300	
EN <sub>-</sub> Logic Input High Current	I <sub>IH</sub>	EN <sub>-</sub> = 5V		0.5	10	μA
Quiescent Supply Current (per Amplifier)	I <sub>S</sub>	Enabled		5.5	7.0	mA
		Disabled (EN <sub>-</sub> = 0V)		0.40	0.55	

MAX4212/MAX4213/MAX4216/MAX4218/MAX4220

# Miniature, 300MHz, Single-Supply, Rail-to-Rail Op Amps with Enable

## AC ELECTRICAL CHARACTERISTICS

( $V_{CC} = +5V$ ,  $V_{EE} = 0V$ ,  $V_{CM} = 2.5V$ ,  $EN_{-} = +5V$ ,  $R_F = 24\Omega$ ,  $R_L = 100\Omega$  to  $V_{CC} / 2$ ,  $V_{OUT} = V_{CC} / 2$ ,  $Av_{CL} = +1$ ,  $T_A = +25^{\circ}C$ , unless otherwise noted.)

PARAMETER	SYMBOL	CONDITIONS		MIN	TYP	MAX	UNITS
Small-Signal -3dB Bandwidth	BW <sub>SS</sub>	V <sub>OUT</sub> = 20mVp-p	MAX4212/MAX4213	300		200	MHz
			MAX4216/MAX4218/MAX4220				
Large-Signal -3dB Bandwidth	BW <sub>LS</sub>	V <sub>OUT</sub> = 2Vp-p		180			MHz
Bandwidth for 0.1dB Gain Flatness	BW <sub>0.1dB</sub>	V <sub>OUT</sub> = 20mVp-p	MAX4212/MAX4213	50		35	MHz
			MAX4216/MAX4218/MAX4220				
Slew Rate	SR	V <sub>OUT</sub> = 2V step		600			V/ $\mu$ s
Settling Time to 0.1%	t <sub>s</sub>	V <sub>OUT</sub> = 2V step		45			ns
Rise/Fall Time	t <sub>R</sub> , t <sub>F</sub>	V <sub>OUT</sub> = 100mVp-p		1			ns
Spurious-Free Dynamic Range	SFDR	f <sub>C</sub> = 5MHz, V <sub>OUT</sub> = 2Vp-p		-78			dBc
Harmonic Distortion	HD	f <sub>C</sub> = 5MHz, V <sub>OUT</sub> = 2Vp-p	2nd harmonic	-78		-82	dBc
			3rd harmonic				
			Total harmonic distortion	-75			dB
Two-Tone, Third-Order Intermodulation Distortion	IP3	f <sub>1</sub> = 10.0MHz, f <sub>2</sub> = 10.1MHz, V <sub>OUT</sub> = 1Vp-p		35			dBc
Input 1dB Compression Point		f <sub>C</sub> = 10MHz, Av <sub>CL</sub> = +2		11			dBm
Differential Phase Error	DP	NTSC, R <sub>L</sub> = 150 $\Omega$		0.02			degrees
Differential Gain Error	DG	NTSC, R <sub>L</sub> = 150 $\Omega$		0.02			%
Input Noise-Voltage Density	e <sub>n</sub>	f = 10kHz		10			nV/ $\sqrt{Hz}$
Input Noise-Current Density	i <sub>n</sub>	f = 10kHz		1.3			pA/ $\sqrt{Hz}$
Input Capacitance	C <sub>IN</sub>			1			pF
Disabled Output Capacitance	C <sub>OUT (OFF)</sub>	EN <sub>-</sub> = 0V		2			pF
Output Impedance	Z <sub>OUT</sub>	f = 10MHz		6			$\Omega$
Amplifier Enable Time	t <sub>ON</sub>			100			ns
Amplifier Disable Time	t <sub>OFF</sub>			1			$\mu$ s
Amplifier Gain Matching		MAX4216/MAX4218/MAX4220, f = 10MHz, V <sub>OUT</sub> = 20mVp-p		0.1			dB
Amplifier Crosstalk	X <sub>TALK</sub>	MAX4216/MAX4218/MAX4220, f = 10MHz, V <sub>OUT</sub> = 2Vp-p		-95			dB

**Note 1:** Tested with  $V_{CM} = +2.5V$ .

**Note 2:** PSR for single +5V supply tested with  $V_{EE} = 0V$ ,  $V_{CC} = +4.5V$  to  $+5.5V$ ; for dual  $\pm 5V$  supply with  $V_{EE} = -4.5V$  to  $-5.5V$ ,  $V_{CC} = +4.5V$  to  $+5.5V$ ; and for single +3.3V supply with  $V_{EE} = 0V$ ,  $V_{CC} = +3.15V$  to  $+3.45V$ .

**Note 3:** Does not include the external feedback network's impedance.

# Miniature, 300MHz, Single-Supply, Rail-to-Rail Op Amps with Enable

## Typical Operating Characteristics

( $V_{CC} = +5V$ ,  $V_{EE} = 0V$ ,  $A_{vCL} = +1$ ,  $R_F = 24\Omega$ ,  $R_L = 100\Omega$  to  $V_{CC} / 2$ ,  $T_A = +25^\circ C$ , unless otherwise noted.)

MAX4212/13/MAX4216/MAX4218/MAX4220

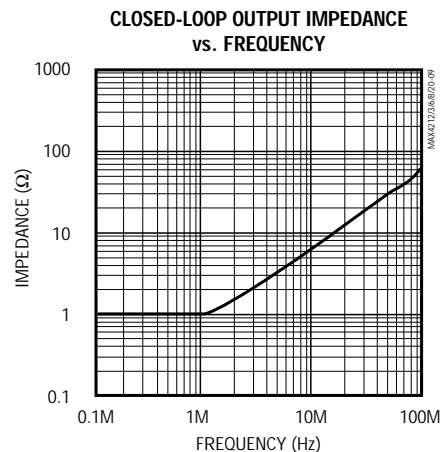
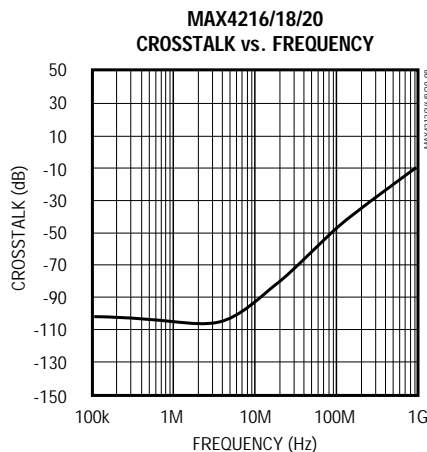
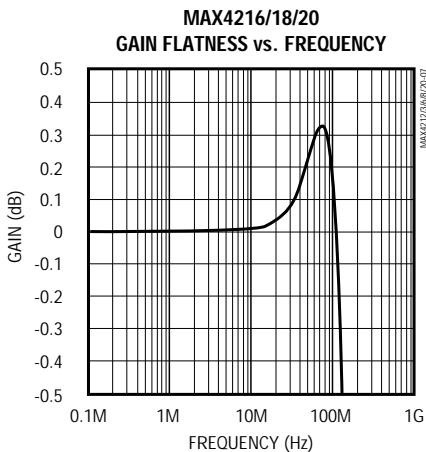
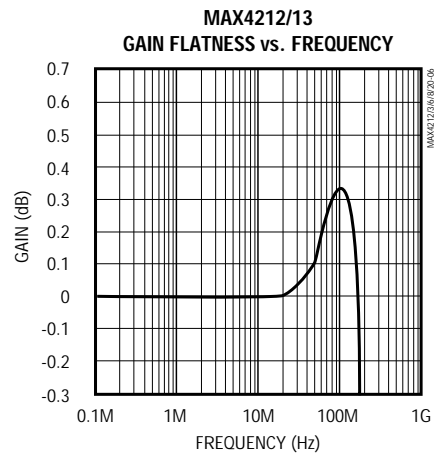
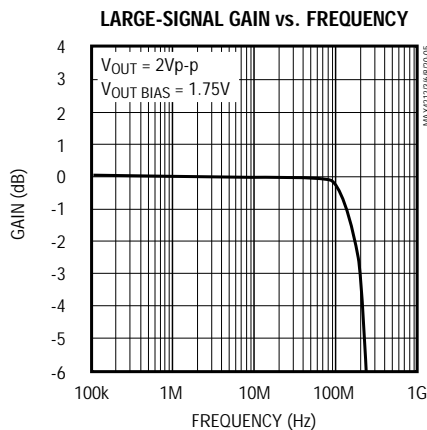
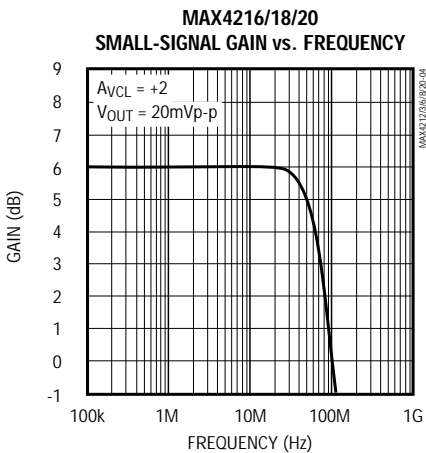
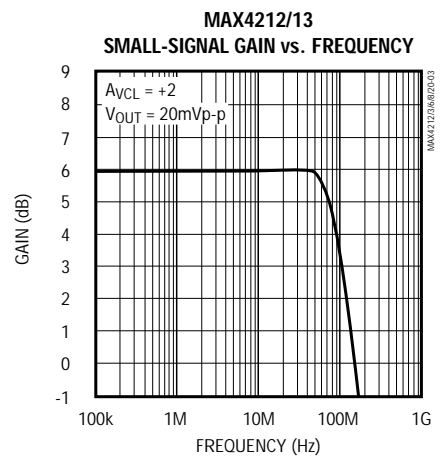
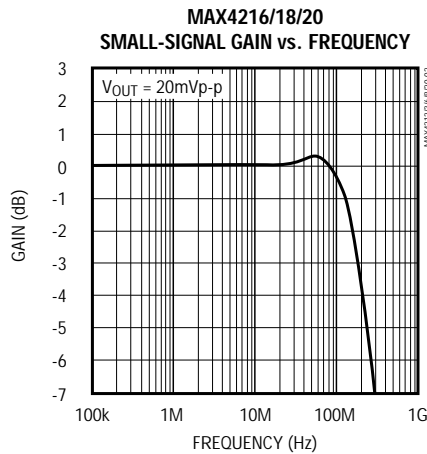
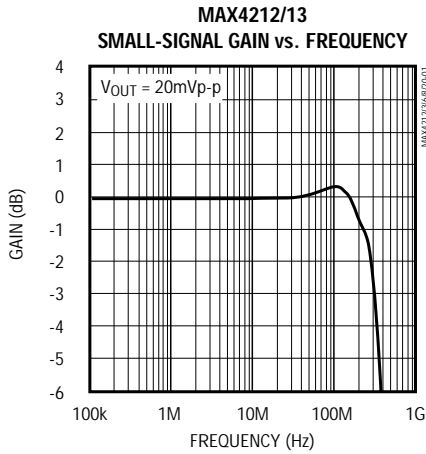

# Miniature, 300MHz, Single-Supply, Rail-to-Rail Op Amps with Enable

## Typical Operating Characteristics (continued)

( $V_{CC} = +5V$ ,  $V_{EE} = 0V$ ,  $A_{vCL} = +1$ ,  $R_F = 24\Omega$ ,  $R_L = 100\Omega$  to  $V_{CC} / 2$ ,  $T_A = +25^\circ C$ , unless otherwise noted.)

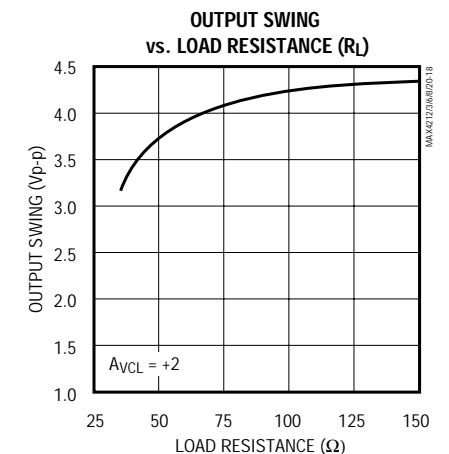
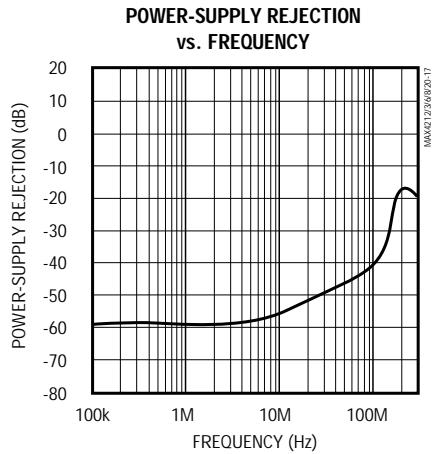
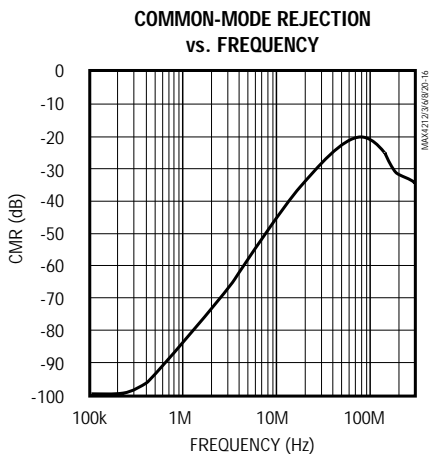
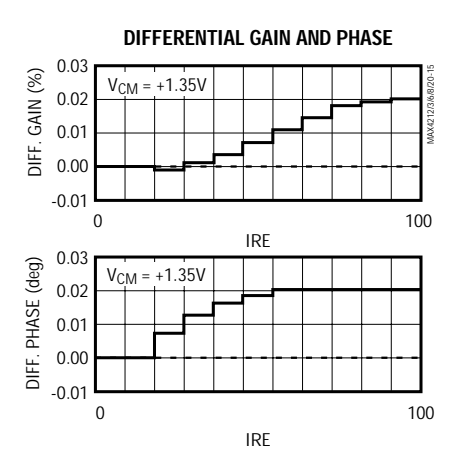
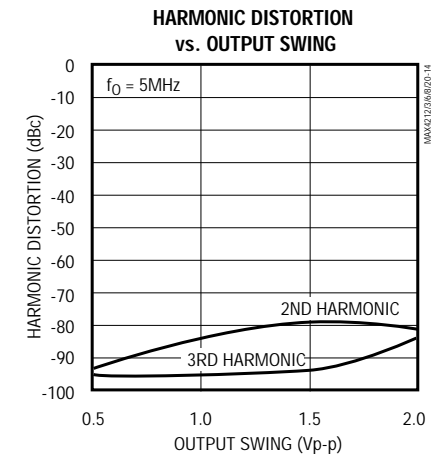
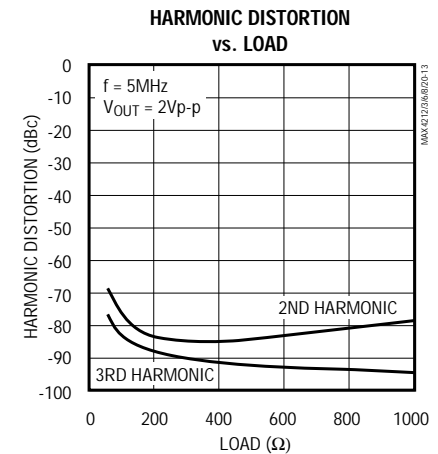
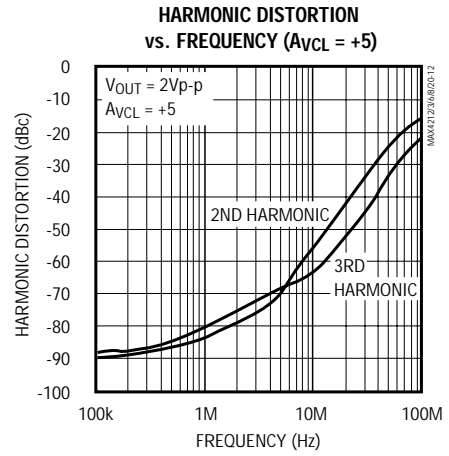
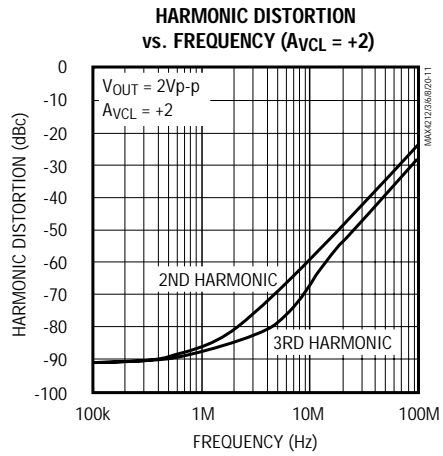
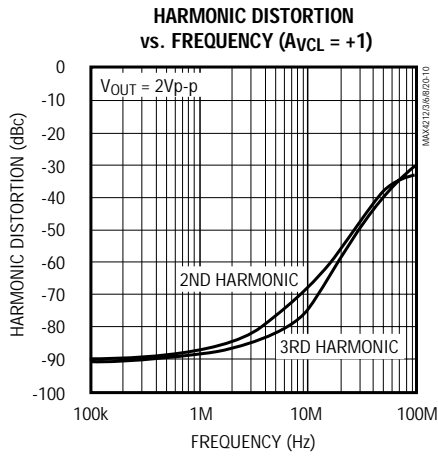

# Miniature, 300MHz, Single-Supply, Rail-to-Rail Op Amps with Enable

## Typical Operating Characteristics (continued)

( $V_{CC} = +5V$ ,  $V_{EE} = 0V$ ,  $A_{vCL} = +1$ ,  $R_F = 24\Omega$ ,  $R_L = 100\Omega$  to  $V_{CC} / 2$ ,  $T_A = +25^\circ C$ , unless otherwise noted.)

**SMALL-SIGNAL PULSE RESPONSE**  
( $A_{vCL} = +1$ )

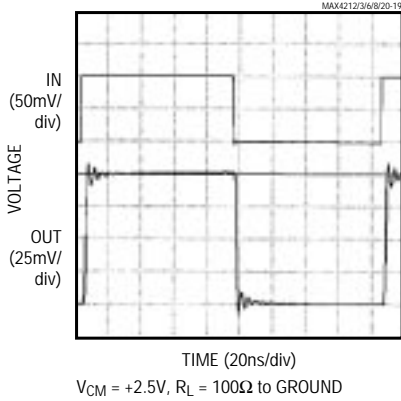

**SMALL-SIGNAL PULSE RESPONSE**  
( $A_{vCL} = +2$ )

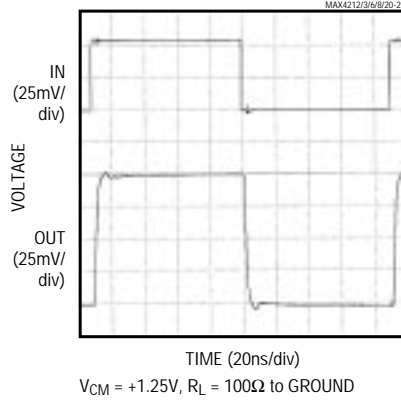

**SMALL-SIGNAL PULSE RESPONSE**  
( $C_L = 5pF$ ,  $A_{vCL} = +1$ )

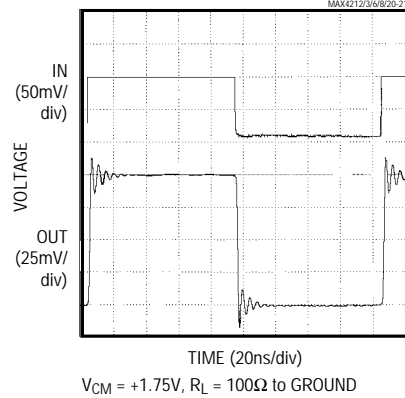

**LARGE-SIGNAL PULSE RESPONSE**  
( $A_{vCL} = +1$ )

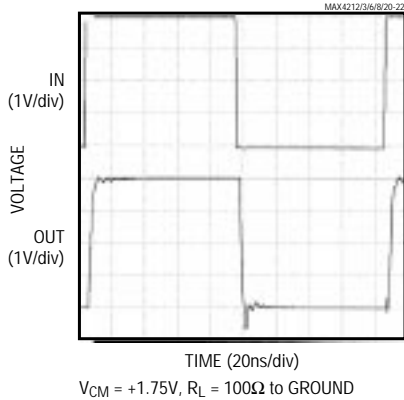

**LARGE-SIGNAL PULSE RESPONSE**  
( $A_{vCL} = +2$ )

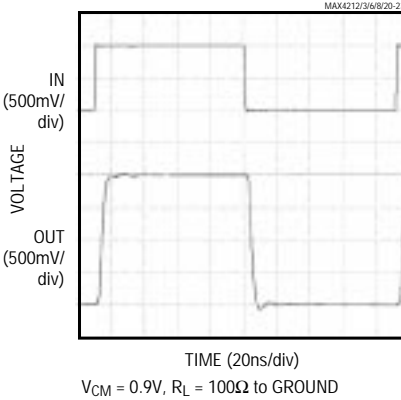

**LARGE-SIGNAL PULSE RESPONSE**  
( $C_L = 5pF$ ,  $A_{vCL} = +2$ )

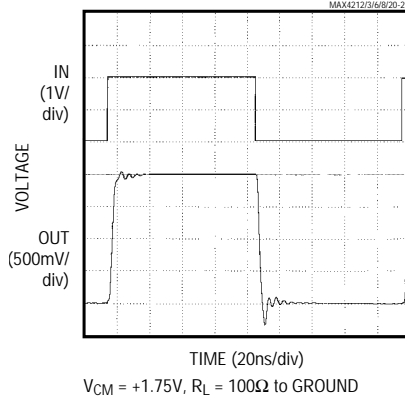

**MAX4213**  
**VOLTAGE NOISE DENSITY**  
**vs. FREQUENCY**

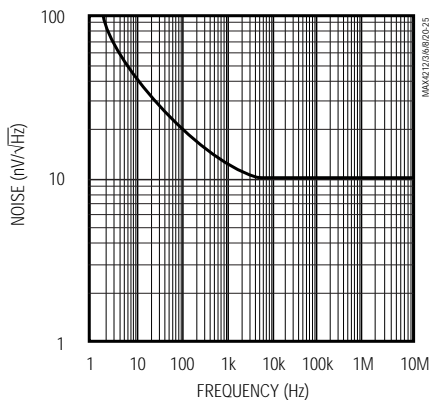

**MAX4218**  
**CURRENT NOISE DENSITY**  
**vs. FREQUENCY**

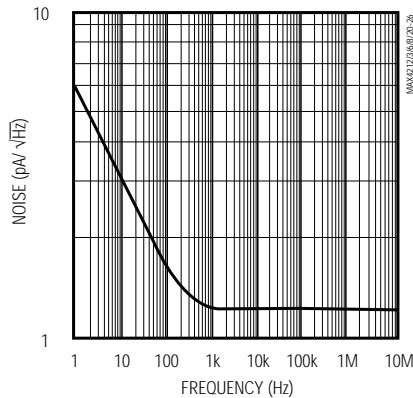

**ENABLE RESPONSE TIME**

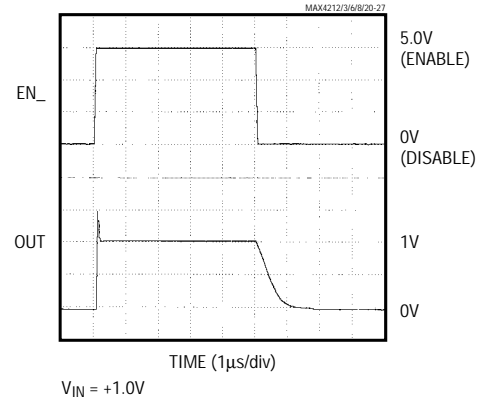

MAX4212/MAX4213/MAX4216/MAX4218/MAX4220

# Miniature, 300MHz, Single-Supply, Rail-to-Rail Op Amps with Enable

## Typical Operating Characteristics (continued)

( $V_{CC} = +5V$ ,  $V_{EE} = 0V$ ,  $A_{VCL} = +1$ ,  $R_F = 24\Omega$ ,  $R_L = 100\Omega$  to  $V_{CC} / 2$ ,  $T_A = +25^\circ C$ , unless otherwise noted.)

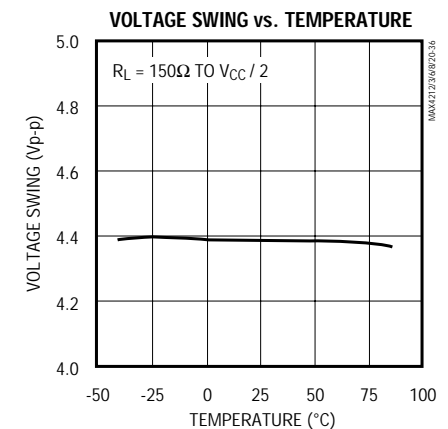
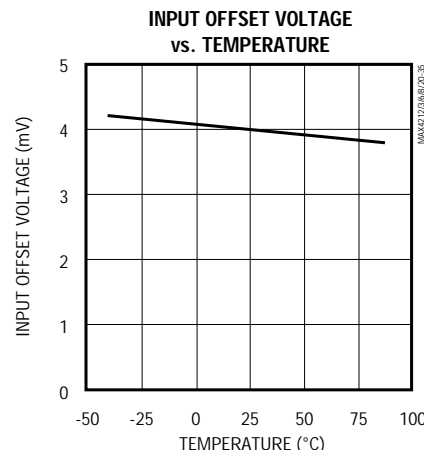
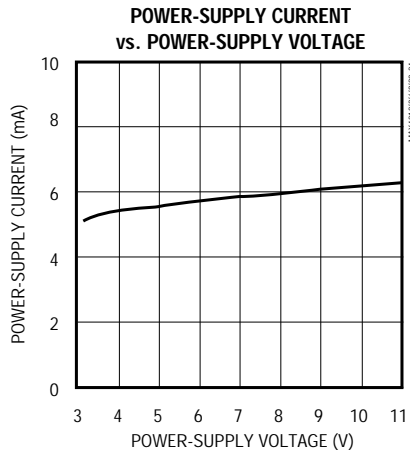
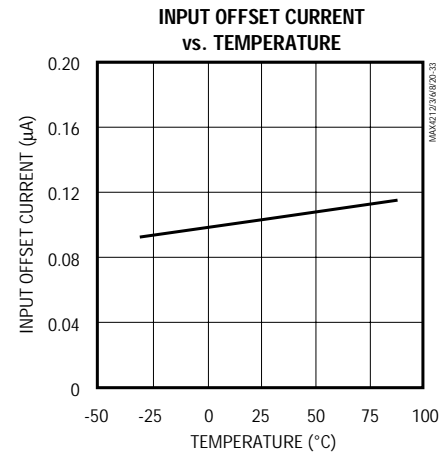
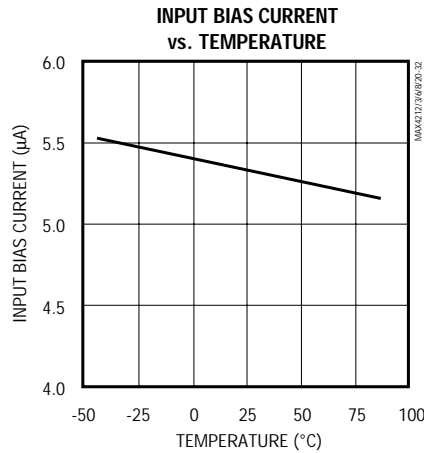
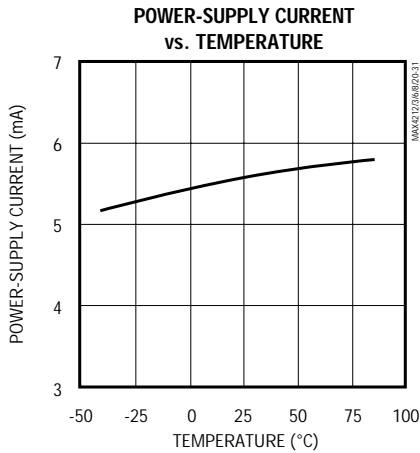
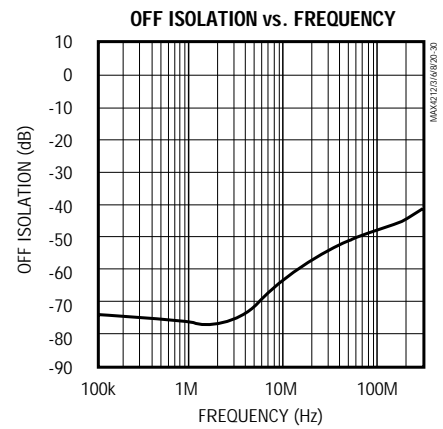
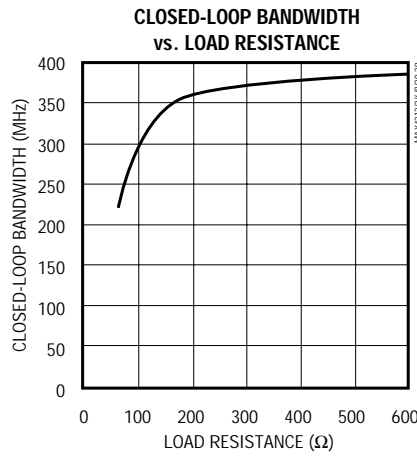
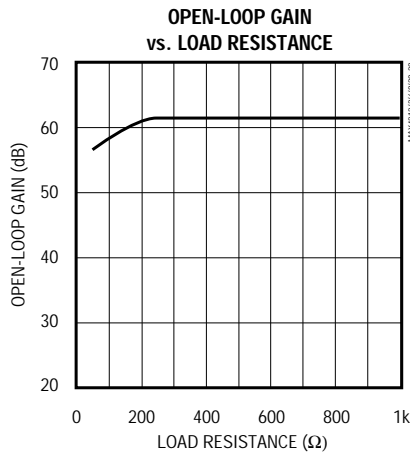



# Miniature, 300MHz, Single-Supply, Rail-to-Rail Op Amps with Enable

## Pin Description

MAX4212 SOT23-5	MAX4213 SO/μMAX	MAX4216 SO/μMAX	PIN				NAME	FUNCTION
			MAX4218		MAX4220			
			SO	QSOP	SO	QSOP		
—	1, 5	—	—	8, 9	—	8, 9	N.C.	No Connect. Not internally connected. Tie to ground or leave open.
1	6	—	—	—	—	—	OUT	Amplifier Output
2	4	4	11	13	11	13	VEE	Negative Power Supply or Ground (in single-supply operation)
3	3	—	—	—	—	—	IN+	Noninverting Input
4	2	—	—	—	—	—	IN-	Inverting Input
5	7	8	4	4	4	4	VCC	Positive Power Supply
—	—	1	7	7	1	1	OUTA	Amplifier A Output
—	—	2	6	6	2	2	INA-	Amplifier A Inverting Input
—	—	3	5	5	3	3	INA+	Amplifier A Noninverting Input
—	—	7	8	10	7	7	OUTB	Amplifier B Output
—	—	6	9	11	6	6	INB-	Amplifier B Inverting Input
—	—	5	10	12	5	5	INB+	Amplifier B Noninverting Input
—	—	—	14	16	8	10	OUTC	Amplifier C Output
—	—	—	13	15	9	11	INC-	Amplifier C Inverting Input
—	—	—	12	14	10	12	INC+	Amplifier C Noninverting Input
—	—	—	—	—	14	16	OUTD	Amplifier D Output
—	—	—	—	—	13	15	IND-	Amplifier D Inverting Input
—	—	—	—	—	12	14	IND+	Amplifier D Noninverting Input
—	8	—	—	—	—	—	EN	Enable Amplifier
—	—	—	1	1	—	—	ENA	Enable Amplifier A
—	—	—	3	3	—	—	ENB	Enable Amplifier B
—	—	—	2	2	—	—	ENC	Enable Amplifier C

MAX4212/MAX4213/MAX4216/MAX4218/MAX4220

# Miniature, 300MHz, Single-Supply, Rail-to-Rail Op Amps with Enable

## Detailed Description

The MAX4212/MAX4213/MAX4216/MAX4218/MAX4220 are single-supply, rail-to-rail, voltage-feedback amplifiers that employ current-feedback techniques to achieve 600V/μs slew rates and 300MHz bandwidths. Excellent harmonic distortion and differential gain/phase performance make these amplifiers an ideal choice for a wide variety of video and RF signal-processing applications.

The output voltage swing comes to within 50mV of each supply rail. Local feedback around the output stage assures low open-loop output impedance to reduce gain sensitivity to load variations. This feedback also produces demand-driven current bias to the output transistors for ±100mA drive capability, while constraining total supply current to less than 7mA. The input stage permits common-mode voltages beyond the negative supply and to within 2.25V of the positive supply rail.

## Applications Information

### Choosing Resistor Values

#### Unity-Gain Configuration

The MAX4212/MAX4213/MAX4216/MAX4218/MAX4220 are internally compensated for unity gain. When configured for unity gain, the devices require a 24Ω resistor (R<sub>F</sub>) in series with the feedback path. This resistor

improves AC response by reducing the Q of the parallel LC circuit formed by the parasitic feedback capacitance and inductance.

#### Inverting and Noninverting Configurations

Select the gain-setting feedback (R<sub>F</sub>) and input (R<sub>G</sub>) resistor values to fit your application. Large resistor values increase voltage noise and interact with the amplifier's input and PC board capacitance. This can generate undesirable poles and zeros and decrease bandwidth or cause oscillations. For example, a noninverting gain-of-two configuration (R<sub>F</sub> = R<sub>G</sub>) using 1kΩ resistors, combined with 1pF of amplifier input capacitance and 1pF of PC board capacitance, causes a pole at 159MHz. Since this pole is within the amplifier bandwidth, it jeopardizes stability. Reducing the 1kΩ resistors to 100Ω extends the pole frequency to 1.59GHz, but could limit output swing by adding 200Ω in parallel with the amplifier's load resistor. Table 1 shows suggested feedback, gain resistors, and bandwidth for several gain values in the configurations shown in Figures 1a and 1b.

#### Layout and Power-Supply Bypassing

These amplifiers operate from a single +3.3V to +11V power supply or from dual supplies to ±5.5V. For single-supply operation, bypass V<sub>CC</sub> to ground with a 0.1μF capacitor as close to the pin as possible. If operating with dual supplies, bypass each supply with a 0.1μF capacitor.

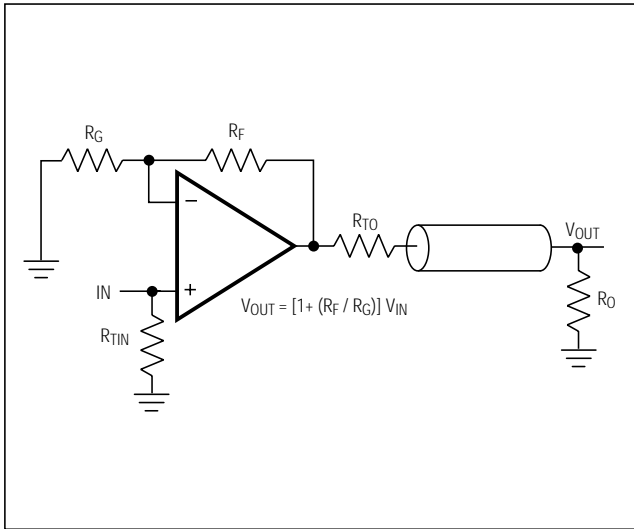

Figure 1a. Noninverting Gain Configuration

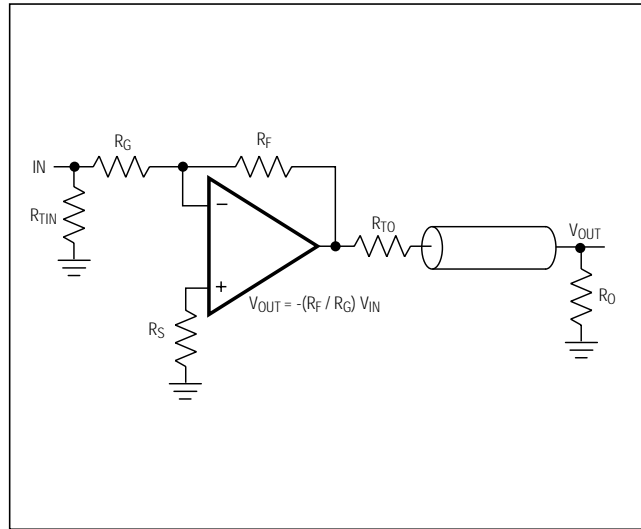

Figure 1b. Inverting Gain Configuration

# Miniature, 300MHz, Single-Supply, Rail-to-Rail Op Amps with Enable

MAX4212/MAX4213/MAX4216/MAX4218/MAX4220

Maxim recommends using microstrip and stripline techniques to obtain full bandwidth. To ensure that the PC board does not degrade the amplifier's performance, design it for a frequency greater than 1GHz. Pay careful attention to inputs and outputs to avoid large parasitic capacitance. Whether or not you use a constant-impedance board, observe the following guidelines when designing the board:

- Don't use wire-wrap boards because they are too inductive.
- Don't use IC sockets because they increase parasitic capacitance and inductance.
- Use surface-mount instead of through-hole components for better high-frequency performance.
- Use a PC board with at least two layers; it should be as free from voids as possible.
- Keep signal lines as short and as straight as possible. Do not make 90° turns; round all corners.

### Rail-to-Rail Outputs, Ground-Sensing Input

The input common-mode range extends from (V<sub>EE</sub> - 200mV) to (V<sub>CC</sub> - 2.25V) with excellent common-mode rejection. Beyond this range, the amplifier output is a nonlinear function of the input, but does not undergo phase reversal or latchup.

The output swings to within 50mV of either power-supply rail with a 10kΩ load. The input ground-sensing and the rail-to-rail output substantially increase the dynamic range. With a symmetric input in a single +5V application, the input can swing 2.95Vp-p, and the output can swing 4.9Vp-p with minimal distortion.

### Enable Input and Disabled Output

The enable feature (EN<sub>1</sub>) allows the amplifier to be placed in a low-power, high-output-impedance state. Typically, the EN<sub>1</sub> logic low input current (I<sub>IL</sub>) is small. However, as the EN voltage (V<sub>IL</sub>) approaches the negative supply rail, I<sub>IL</sub> increases (Figure 2). A single resistor connected as shown in Figure 3 prevents the rise in the logic-low input current. This resistor provides a feedback mechanism that increases V<sub>IL</sub> as the logic input is brought to V<sub>EE</sub>. Figure 4 shows the resulting input current (I<sub>IL</sub>).

When the MAX4213/MAX4218 are disabled, the amplifier's output impedance is 35kΩ. This high resistance and the low 2pF output capacitance make these parts ideal in RF/video multiplexer or switch applications. For larger arrays, pay careful attention to capacitive loading. See the *Output Capacitive Loading and Stability* section for more information.

**Table 1. Recommended Component Values**

COMPONENT	GAIN (V/V)									
	+1	-1	+2	-2	+5	-5	+10	-10	+25	-25
R <sub>F</sub> (Ω)	24	500	500	500	500	500	500	500	500	1200
R <sub>G</sub> (Ω)	∞	500	500	250	124	100	56	50	20	50
R <sub>S</sub> (Ω)	—	0	—	0	—	0	—	0	—	0
R <sub>TIN</sub> (Ω)	49.9	56	49.9	62	49.9	100	49.9	∞	49.9	∞
R <sub>TO</sub> (Ω)	49.9	49.9	49.9	49.9	49.9	49.9	49.9	49.9	49.9	49.9
Small-Signal -3dB Bandwidth (MHz)	300	90	105	60	25	33	11	25	6	10

**Note:** R<sub>L</sub> = R<sub>O</sub> + R<sub>TO</sub>; R<sub>TIN</sub> and R<sub>TO</sub> are calculated for 50Ω applications. For 75Ω systems, R<sub>TO</sub> = 75Ω; calculate R<sub>TIN</sub> from the following equation:

$$R_{TIN} = \frac{75}{1 - \frac{75}{R_G}} \Omega$$

# Miniature, 300MHz, Single-Supply, Rail-to-Rail Op Amps with Enable

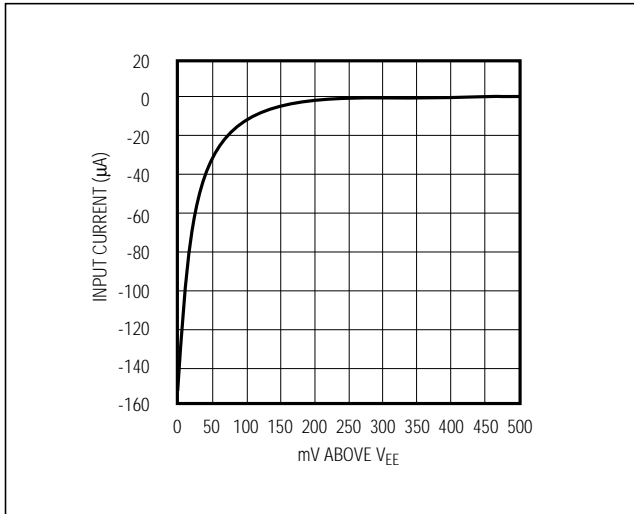

Figure 2. Enable Logic-Low Input Current vs.  $V_{IL}$

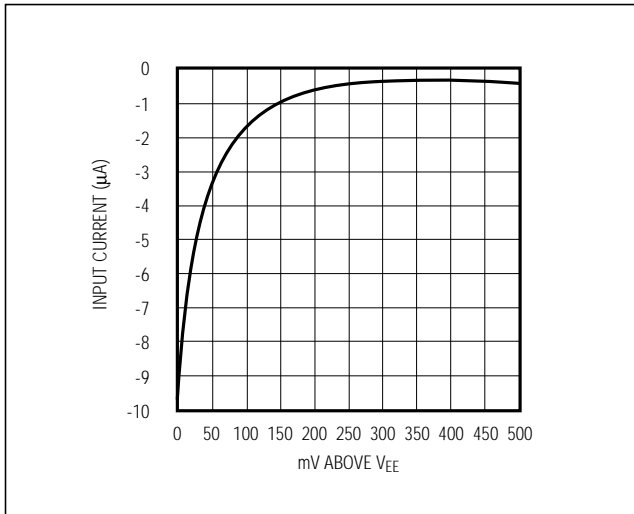

Figure 4. Enable Logic-Low Input Current vs.  $V_{IL}$  with 10k $\Omega$  Series Resistor

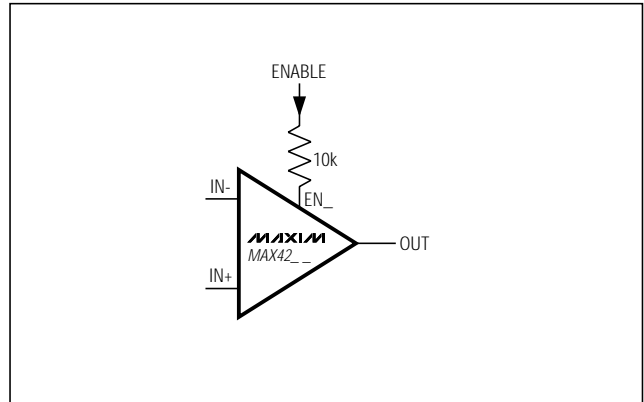

Figure 3. Circuit to Reduce Enable Logic-Low Input Current

### Output Capacitive Loading and Stability

The MAX4212/MAX4213/MAX4216/MAX4218/MAX4220 are optimized for AC performance. They are not designed to drive highly reactive loads, which decreases phase margin and may produce excessive ringing and oscillation. Figure 5 shows a circuit that eliminates this problem. Figure 6 is a graph of the optimal isolation resistor ( $R_S$ ) vs. capacitive load. Figure 7 shows how a capacitive load causes excessive peaking of the amplifier's frequency response if the capacitor is not isolated from the amplifier by a resistor. A small isolation resistor (usually 20 $\Omega$  to 30 $\Omega$ ) placed before the reactive load prevents ringing and oscillation. At higher capacitive loads, AC performance is controlled by the interaction of the load capacitance and the isolation resistor. Figure 8 shows the effect of a 27 $\Omega$  isolation resistor on closed-loop response.

Coaxial cable and other transmission lines are easily driven when properly terminated at both ends with their characteristic impedance. Driving back-terminated transmission lines essentially eliminates the line's capacitance.

# Miniature, 300MHz, Single-Supply, Rail-to-Rail Op Amps with Enable

MAX4212/MAX4213/MAX4216/MAX4218/MAX4220

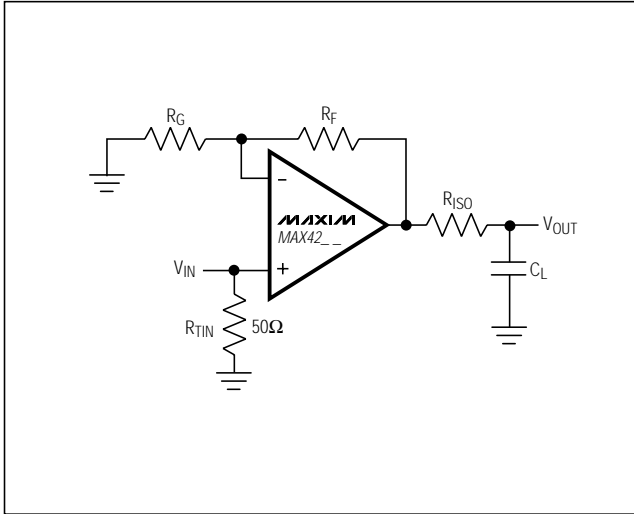

Figure 5. Driving a Capacitive Load through an Isolation Resistor

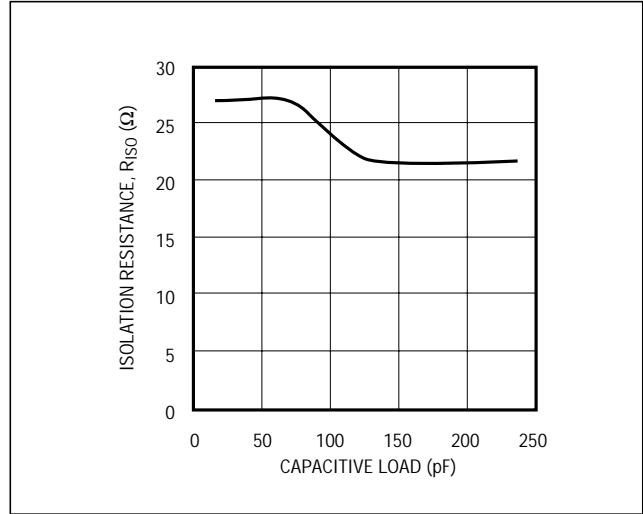

Figure 6. Capacitive Load vs. Isolation Resistance

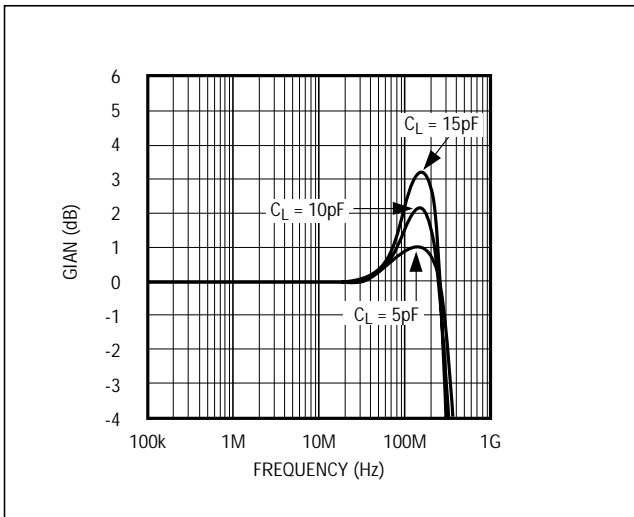

Figure 7. Small-Signal Gain vs. Frequency with Load Capacitance and No Isolation Resistor

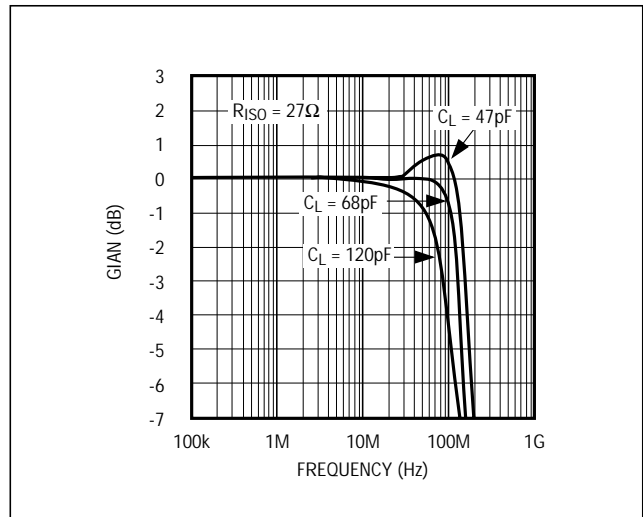
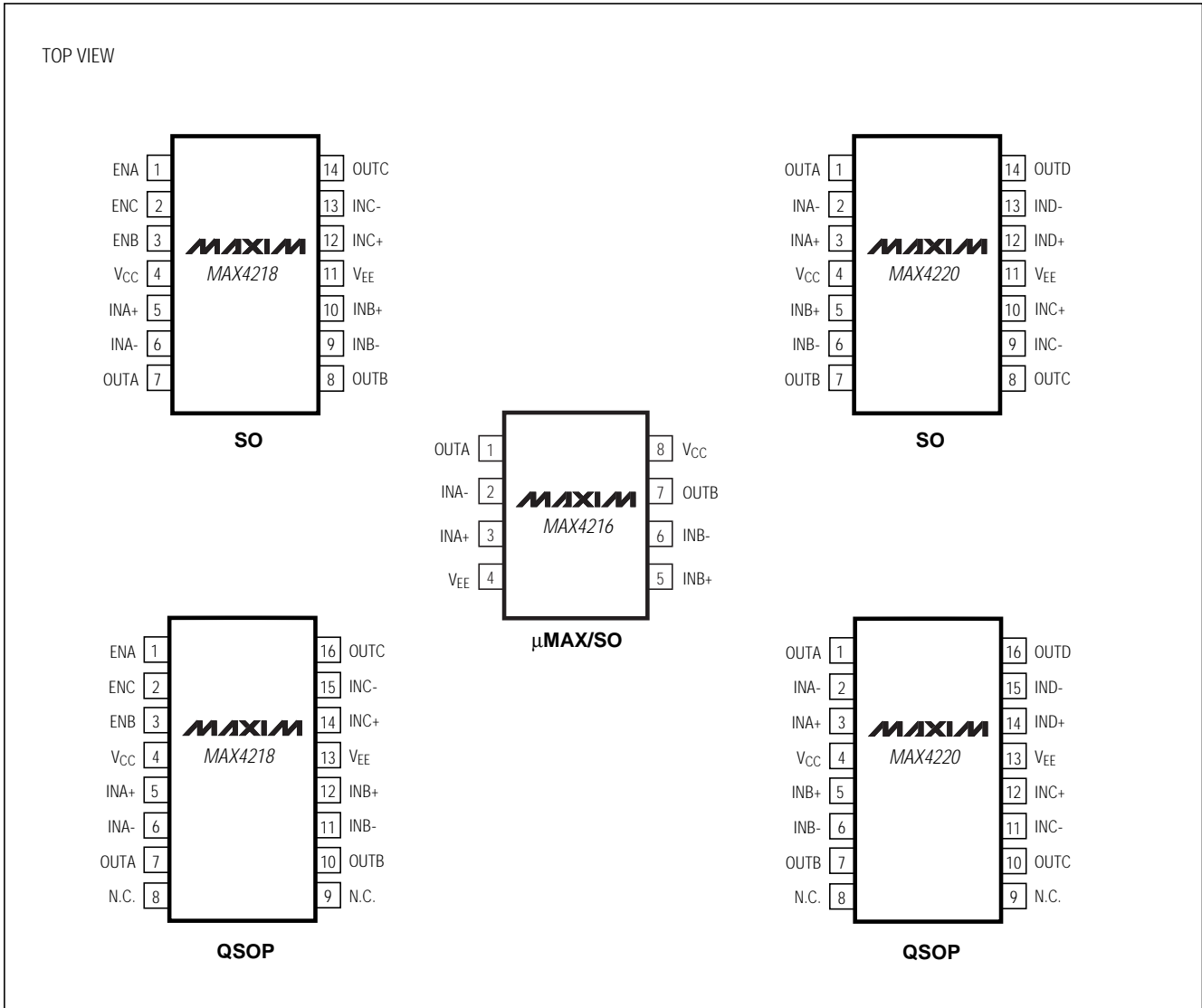

Figure 8. Small-Signal Gain vs. Frequency with Load Capacitance and  $27\Omega$  Isolation Resistor

# Miniature, 300MHz, Single-Supply, Rail-to-Rail Op Amps with Enable

Pin Configurations (continued)



# Miniature, 300MHz, Single-Supply, Rail-to-Rail Op Amps with Enable

## Ordering Information (continued)

PART	TEMP. RANGE	PIN-PACKAGE	SOT TOP MARK
<b>MAX4216</b> ESA	-40°C to +85°C	8 SO	—
MAX4216EUA	-40°C to +85°C	8 $\mu$ MAX	—
<b>MAX4218</b> ESD	-40°C to +85°C	14 SO	—
MAX4218EEE	-40°C to +85°C	16 QSOP	—
<b>MAX4220</b> ESD	-40°C to +85°C	14 SO	—
MAX4220EEE	-40°C to +85°C	16 QSOP	—

## Chip Information

PART	TRANSISTOR COUNT
MAX4212/MAX4213	95
MAX4216	190
MAX4218	299
MAX4220	362

MAX4212/MAX4213/MAX4216/MAX4218/MAX4220

## Package Information

SYMBOL	MIN	MAX
A	0.90	1.45
A1	0.00	0.15
A2	0.90	1.30
b	0.35	0.50
C	0.08	0.20
D	2.80	3.00
E	2.60	3.00
E1	1.50	1.75
L	0.35	0.55
e	0.95 REF	
e1	1.90 REF	
$\alpha$	0°	10°

NOTE:

- ALL DIMENSIONS ARE IN MILLIMETERS.
- FOOT LENGTH MEASURED AT INTERCEPT POINT BETWEEN DATUM A & LEAD SURFACE.
- PACKAGE OUTLINE EXCLUSIVE OF MOLD FLASH & METAL BURR.
- PACKAGE OUTLINE INCLUSIVE OF SOLDER PLATING.

SOT23LEPS

<b>MAXIM</b>		
PROPRIETARY INFORMATION		
TITLE: PACKAGE OUTLINE, SOT23, 5L		
APPROVAL	DOCUMENT CONTROL NO	REV
	21-0057	B 1/1

# Miniature, 300MHz, Single-Supply, Rail-to-Rail Op Amps with Enable

## Package Information (continued)

DIM	INCHES		MILLIMETERS		JEDEC			
	MIN	MAX	MIN	MAX	MIN	MAX	MIN	MAX
A	0.037	0.043	0.94	1.10	---	0.043	---	1.10
A1	0.002	0.006	0.05	0.15	0.002	0.006	0.05	0.15
B	0.010	0.014	0.25	0.36	0.010	0.016	0.25	0.40
C	0.005	0.007	0.13	0.18	0.005	0.009	0.13	0.23
D	0.116	0.120	2.95	3.05	0.114	0.122	2.9	3.1
e	0.0256 BSC		0.65 BSC		0.0256 BSC		0.64 BSC	
E	0.116	0.120	2.95	3.05	0.114	0.122	2.9	3.1
H	0.188	0.198	4.78	5.03	0.193	BSC	4.9	BSC
L	0.016	0.026	0.41	0.66	0.016	0.027	0.40	0.70
α	0°	6°	0°	6°	0°	6°	0°	6°

NOTES:  
 1. D & E DO NOT INCLUDE MOLD FLASH  
 2. MOLD FLASH OR PROTRUSIONS NOT TO EXCEED .15mm(.006")  
 3. CONTROLLING DIMENSION: MILLIMETERS.  
 4. MEETS JEDEC MO-187.

**MAXIM**  
 PROPRIETARY INFORMATION  
 TITLE: BL\_UMAX PACKAGE OUTLINE DWG.  
 APPROVAL: DOCUMENT CONTROL NO: 21-0036 REV: F 1/1

DIM	INCHES		MILLIMETERS	
	MIN	MAX	MIN	MAX
A	.061	.068	1.55	1.73
A1	.004	.0098	0.102	0.249
A2	.055	.061	1.40	1.55
B	.008	.012	0.20	0.31
C	.0075	.0098	0.191	0.249
D	SEE VARIATIONS			
E	.150	.157	3.81	3.99
e	.025 BSC		0.635 BSC	
H	.230	.244	5.84	6.20
h	.010	.016	0.25	0.41
L	.016	.035	0.41	0.89
N	SEE VARIATIONS			
X	SEE VARIATIONS			
Y	.071	.087	1.803	2.209
α	0°	8°	0°	8°

VARIATIONS:

DIM	INCHES		MILLIMETERS		N
	MIN	MAX	MIN	MAX	
D	.189	.196	4.80	4.98	16 AA
S	.0020	.0070	0.05	0.18	
X	.107	.123	2.72	3.12	
D	.337	.344	8.56	8.74	20 AB
S	.0500	.0550	1.270	1.397	
D	.337	.344	8.56	8.74	24 AC
S	.0250	.0300	0.635	0.762	
D	.386	.393	9.80	9.98	28 AD
S	.0250	.0300	0.635	0.762	
X	.271	.287	6.88	7.29	

NOTES:  
 1. D & E DO NOT INCLUDE MOLD FLASH OR PROTRUSIONS  
 2. MOLD FLASH OR PROTRUSIONS NOT TO EXCEED .006" PER SIDE.  
 3. HEAT SLUG DIMENSIONS X AND Y APPLY ONLY TO 16 AND 28 LEAD POWER-QSOP PACKAGES.  
 4. CONTROLLING DIMENSIONS: INCHES.

**MAXIM**  
 PROPRIETARY INFORMATION  
 TITLE: PACKAGE OUTLINE, QSOP, 150°, .025" LEAD PITCH  
 APPROVAL: DOCUMENT CONTROL NO: 21-0055 REV: B 1/1