

# Cascadable Silicon Bipolar MMIC Amplifier

## Technical Data

### MSA-0885

#### Features

- **Usable Gain to 6.0 GHz**
- **High Gain:**  
32.5 dB Typical at 0.1 GHz  
22.5 dB Typical at 1.0 GHz
- **Low Noise Figure:**  
3.3 dB Typical at 1.0 GHz
- **Low Cost Plastic Package**

#### Description

The MSA-0885 is a high performance silicon bipolar Monolithic Microwave Integrated Circuit (MMIC) housed in a low cost plastic package. This MMIC is designed for use as a general

purpose 50 Ω gain block above 0.5 GHz and can be used as a high gain transistor below this frequency. Typical applications include narrow and moderate band IF and RF amplifiers in commercial and industrial applications.

The MSA-series is fabricated using HP's 10 GHz  $f_T$ , 25 GHz  $f_{MAX}$ , silicon bipolar MMIC process which uses nitride self-alignment, ion implantation, and gold metallization to achieve excellent performance, uniformity and reliability. The use of an external bias resistor for temperature and current stability also allows bias flexibility.

#### 85 Plastic Package

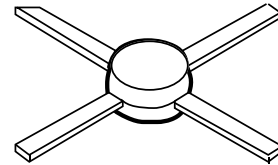

#### Typical Biasing Configuration

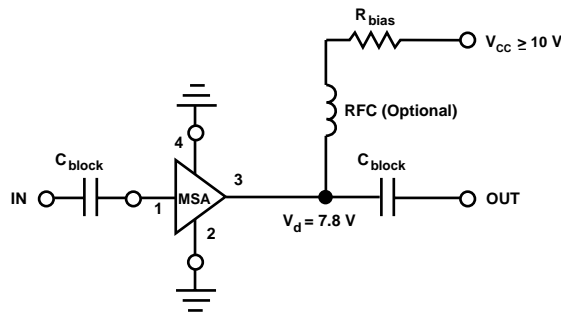

## MSA-0885 Absolute Maximum Ratings

Parameter	Absolute Maximum <sup>[1]</sup>
Device Current	65 mA
Power Dissipation <sup>[2,3]</sup>	500 mW
RF Input Power	+13 dBm
Junction Temperature	150°C
Storage Temperature	-65°C to 150°C

**Thermal Resistance<sup>[2,4]</sup>:**

$$\theta_{jc} = 130^{\circ}\text{C/W}$$

### Notes:

1. Permanent damage may occur if any of these limits are exceeded.
2.  $T_{\text{CASE}} = 25^{\circ}\text{C}$ .
3. Derate at  $7.7 \text{ mW/}^{\circ}\text{C}$  for  $T_{\text{C}} > 85^{\circ}\text{C}$ .
4. See MEASUREMENTS section “Thermal Resistance” for more information.

## Electrical Specifications<sup>[1]</sup>, $T_{\text{A}} = 25^{\circ}\text{C}$

Symbol	Parameters and Test Conditions: $I_{\text{d}} = 36 \text{ mA}$ , $Z_{\text{o}} = 50 \Omega$	Units	Min.	Typ.	Max.
GP	Power Gain ( $ S_{21} ^2$ ) $f = 0.1 \text{ GHz}$ $f = 1.0 \text{ GHz}$	dB	21.0	32.5 22.5	
VSWR	Input VSWR $f = 0.1 \text{ to } 3.0 \text{ GHz}$			1.9:1	
	Output VSWR $f = 0.1 \text{ to } 3.0 \text{ GHz}$			1.6:1	
NF	50 $\Omega$ Noise Figure $f = 1.0 \text{ GHz}$	dB		3.3	
$P_{1 \text{ dB}}$	Output Power at 1 dB Gain Compression $f = 1.0 \text{ GHz}$	dBm		12.5	
$\text{IP}_3$	Third Order Intercept Point $f = 1.0 \text{ GHz}$	dBm		27.0	
$t_{\text{D}}$	Group Delay $f = 1.0 \text{ GHz}$	psec		125	
$V_{\text{d}}$	Device Voltage	V	6.2	7.8	9.4
$\text{dV/dT}$	Device Voltage Temperature Coefficient	mV/°C		-17.0	

### Note:

1. The recommended operating current range for this device is 20 to 40 mA. Typical performance as a function of current is on the following page.

## MSA-0885 Typical Scattering Parameters<sup>[1]</sup> ( $Z_0 = 50 \Omega$ , $T_A = 25^\circ\text{C}$ , $I_d = 36 \text{ mA}$ )

Freq. GHz	$S_{11}$		$S_{21}$			$S_{12}$			$S_{22}$		k
	Mag	Ang	dB	Mag	Ang	dB	Mag	Ang	Mag	Ang	
0.1	.64	-21	32.5	42.29	160	-36.5	.015	40	.61	-24	0.78
0.2	.58	-39	31.3	36.89	144	-32.8	.023	50	.54	-45	0.67
0.4	.44	-65	28.7	27.20	120	-29.4	.034	54	.42	-77	0.69
0.6	.36	-82	26.3	20.57	106	-27.2	.044	53	.33	-98	0.77
0.8	.31	-95	24.3	16.31	96	-25.2	.055	53	.28	-115	0.83
1.0	.27	-105	22.5	13.36	87	-24.2	.061	51	.25	-129	0.87
1.5	.24	-125	19.3	9.24	71	-21.4	.085	50	.18	-153	0.96
2.0	.26	-147	16.7	6.82	56	-19.7	.103	47	.15	-173	0.98
2.5	.29	-159	14.9	5.57	48	-18.4	.120	44	.12	180	1.00
3.0	.34	-175	13.1	4.51	37	-17.7	.130	42	.09	165	1.03
3.5	.38	172	11.6	3.80	25	-16.9	.144	37	.06	172	1.04
4.0	.42	161	10.1	3.21	14	-16.3	.153	33	.04	-139	1.06
5.0	.48	135	7.7	2.43	-7	-15.6	.167	24	.09	-90	1.09
6.0	.60	102	5.5	1.88	-29	-14.9	.179	17	.08	-140	1.06

### Note:

1. A model for this device is available in the DEVICE MODELS section.

## Typical Performance, $T_A = 25^\circ\text{C}$

(unless otherwise noted)

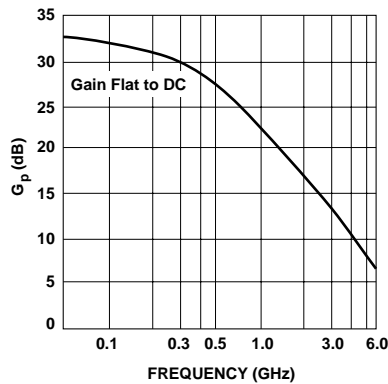

Figure 1. Typical Power Gain vs. Frequency,  $I_d = 36 \text{ mA}$ .

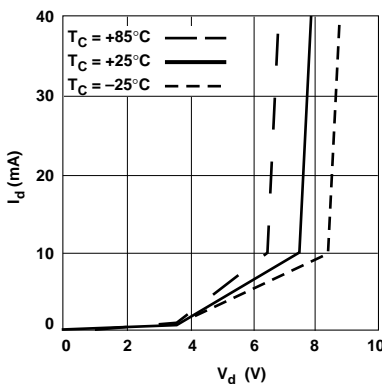

Figure 2. Device Current vs. Voltage.

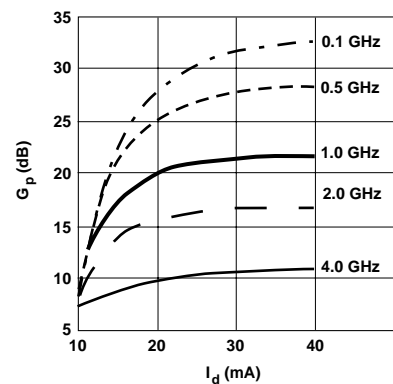

Figure 3. Power Gain vs. Current.

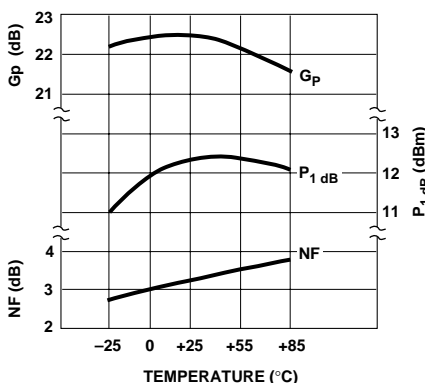

Figure 4. Output Power at 1 dB Gain Compression, NF and Power Gain vs. Case Temperature,  $f = 1.0 \text{ GHz}$ ,  $I_d = 36 \text{ mA}$ .

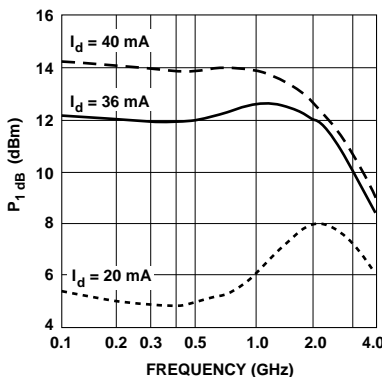

Figure 5. Output Power at 1 dB Gain Compression vs. Frequency.

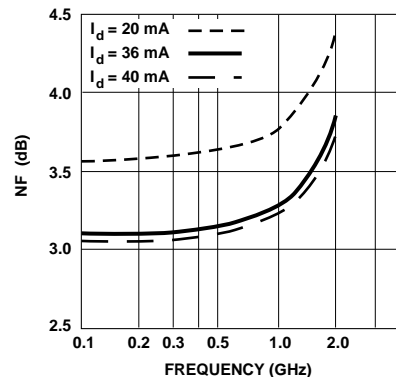

Figure 6. Noise Figure vs. Frequency.

# 85 Plastic Package Dimensions

