

1.5A Low Dropout Positive Adjustable Regulator

FEATURES

- Dropout Voltage 1.3V at 1.5A Output Current.
- Fast Transient Response.
- Line Regulation typically at 0.015%.
- Load Regulation typically at 0.1%.
- Internal Thermal and Current Limiting.
- Adjustable Output Voltage or Fixed 2.85V, 3.3V, 5V.
- Standard 3-Pin Power Packages.

APPLICATIONS

- Post Regulator for Switching Supply.
- Battery Chargers.
- Constant-Current Regulators.
- PC Add-On Card.

DESCRIPTION

The AIC1086 is a low dropout three terminal regulator with 1.5A output current capability. The output voltage is adjustable with the use of a resistor divider or fixed 2.85V, 3.3V, 5V. Dropout is guaranteed at a maximum of 1.5V at maximum output current. Its low dropout voltage and fast transient response make it ideal for low voltage microprocessor applications. Internal current and thermal limiting provides protection against any overload condition that would create excessive junction temperatures.

TYPICAL APPLICATION CIRCUIT

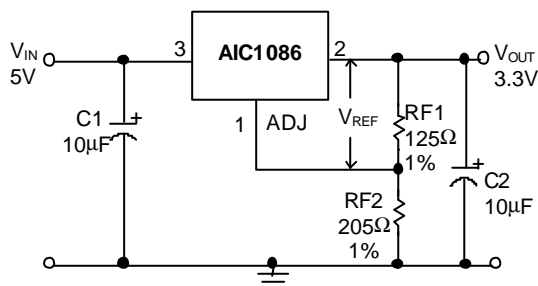

Adjustable Voltage Regulator

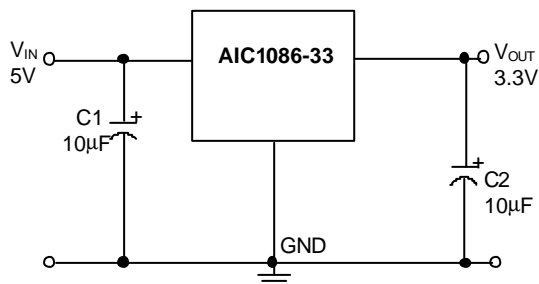

Fixed Voltage Regulator

$$V_{REF} = V_{OUT} - V_{ADJ} = 1.25V \text{ (typ.)}$$

$$V_{OUT} = V_{REF} \times (1 + RF2/RF1) + I_{ADJ} \times RF2$$

$$I_{ADJ} = 55\mu A \text{ (typ.)}$$

- (1) C1 needed if device is far away from filter capacitors.
- (2) C2 required for stability.

ORDERING INFORMATION

AIC1086-XXXX

└─┬─┘	PACKAGING TYPE
	E: TO-252 M: TO-263 T: TO-220 Y: SOT-223
└─┬─┘	TEMPERATURE RANGE
	C: 0°C~+70°C
└─┬─┘	DEFAULT:ADJ.
	28: 2.85V
	33: 3.3V
	50: 5.0V

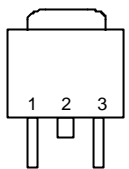
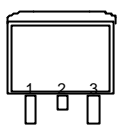
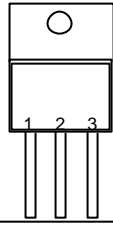
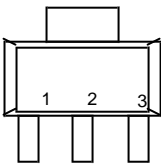
ORDER NUMBER	PIN CONFIGURATION
AIC1086CE (TO-252)	FRONT VIEW 1: ADJ 2: VOUT (TAB) 3: VIN 
AIC1086CM (TO-263)	FRONT VIEW 1: ADJ 2: VOUT (TAB) 3: VIN 
AIC1086CT (TO-220)	FRONT VIEW 1: ADJ 2: VOUT (TAB) 3: VIN 
AIC1086CY (SOT-223)	FRONT VIEW 1: ADJ 2: VOUT (TAB) 3: VIN 

ABSOLUTE MAXIMUM RATINGS

VIN pin to ADJ/GND pin	7V
Operating Junction Temperature Range	0°C ~ 125°C
Storage Temperature Range	- 65°C ~ 150°C
Thermal Resistance (Junction to Case)	TO-220 3°C /W
	TO-2633°C /W
	SOT-22315°C /W
Lead Temperature (Soldering) 10 sec.	260°C

ELECTRICAL CHARACTERISTICS ($V_{IN}=5V$, $T_J=25^\circ C$, $I_O=10mA$, Unless otherwise specified)

PARAMETER	TEST CONDITIONS	MIN.	TYP.	MAX.	UNIT
Reference Voltage	AIC1086 (Adj.) $T_J=25^\circ C$ $0^\circ C \leq T_J \leq 125^\circ C$	1.238 1.225	1.25 1.25	1.262 1.275	V
Output Voltage	AIC1086-28, $V_{IN}=5V$ AIC1086-33, $V_{IN}=5V$ AIC1086-50, $V_{IN}=7V$	2.82 3.26 4.95	2.85 3.30 5.00	2.88 3.33 5.05	V
Line Regulation	$2.65 \leq V_{IN} \leq 7V$ $T_J=25^\circ C$ $0^\circ C \leq T_J \leq 125^\circ C$		0.015 0.035	0.2 0.2	%
Load Regulation	$T_J=25^\circ C$, $I_O=10mA \sim 1.5A$ $0^\circ C \leq T_J \leq 125^\circ C$		0.1 0.2	0.3 0.4	%
Dropout Voltage	$\Delta V_{OUT}, \Delta V_{REF}=1\%$ $I_O=1.5A$ $0^\circ C \leq T_J \leq 125^\circ C$		1.3	1.5	V
Current Limit	$0^\circ C \leq T_J \leq 125^\circ C$	1.5	2.0		A
Adjusted Pin Current (I_{ADJ})	$2.65 \leq V_{IN} \leq 7V$ $10mA \leq I_O \leq 1.5A$ $0^\circ C \leq T_J \leq 125^\circ C$		55	120	μA
Adjusted Pin Current Change (ΔI_{ADJ})	$2.65 \leq V_{IN} \leq 7V$ $10mA \leq I_O \leq 1.5A$ $0^\circ C \leq T_J \leq 125^\circ C$		0.2	5	μA
Temperature Stability	$I_O=0.5A$ $0^\circ C \leq T_J \leq 125^\circ C$		0.5		%
Minimum Load Current	$0^\circ C \leq T_J \leq 125^\circ C$		5	10	mA
RMS Output Noise (% of V_{OUT})	$10Hz \leq f \leq 10KHz$		0.003		%
Ripple Rejection Ratio	120Hz input ripple $C_{OUT}=25\mu F$	60	72		dB

TYPICAL PERFORMANCE CHARACTERISTICS

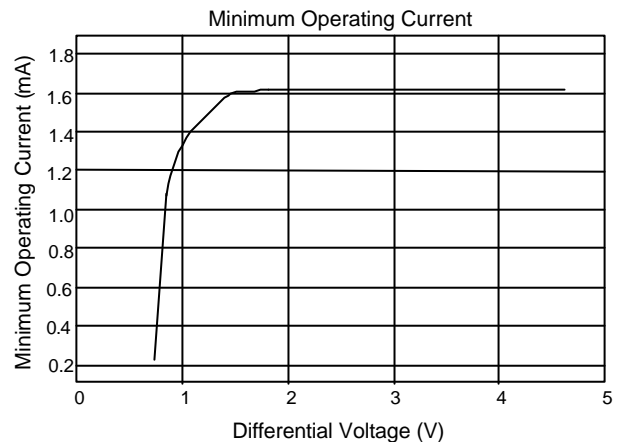
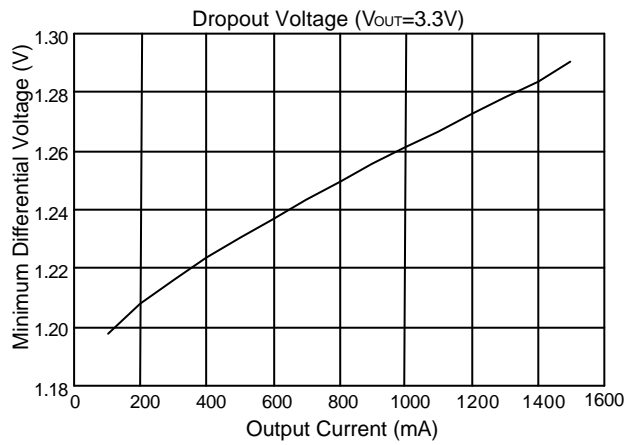
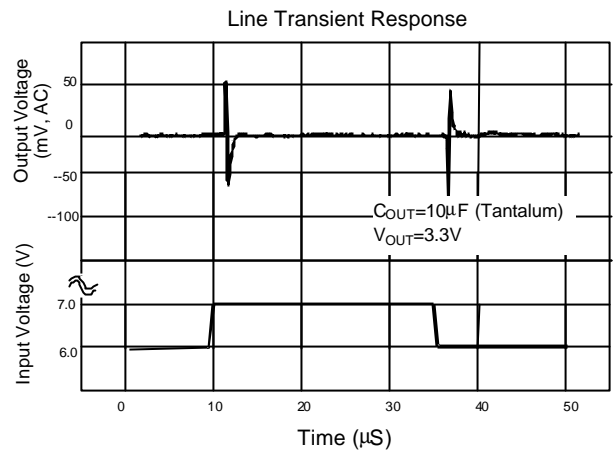
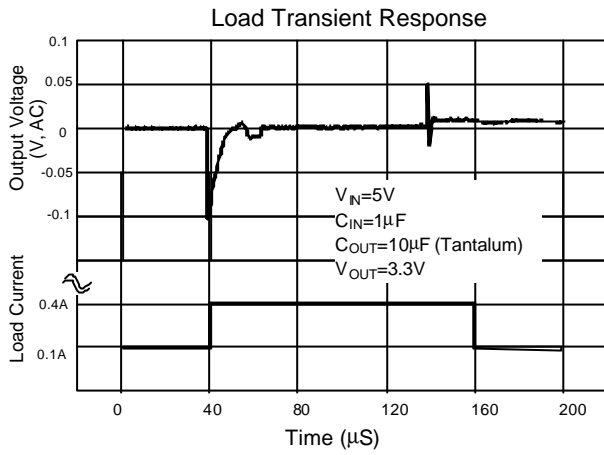

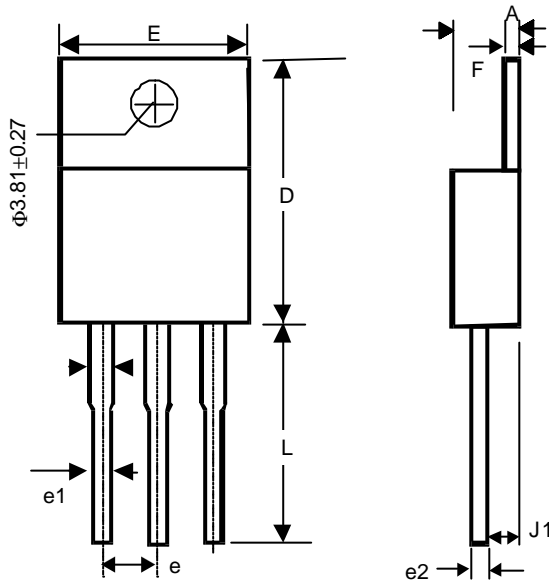
PHYSICAL DIMENSIONS
TO-220 (unit: mm)

SYMBOL	MIN	MAX
A	3.56	4.82
D	14.23	16.51
E	9.66	10.66
e	2.29	2.79
e1	0.50	1.15
e2	-	1.10
F	0.51	1.39
J1	2.04	2.92
L	12.70	14.73

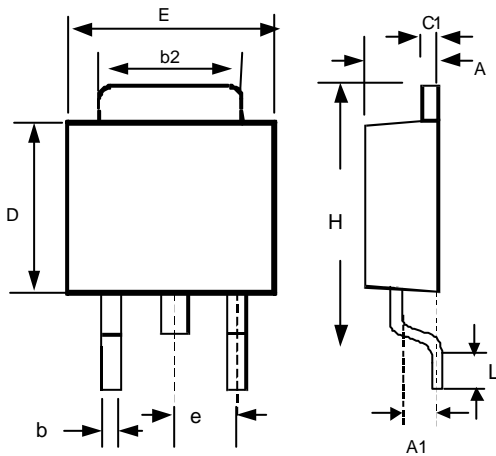
TO-252 (unit: mm)

SYMBOL	MIN	MAX
A	2.19	2.38
A1	1.02	1.27
b	0.64	0.88
b2	5.21	5.46
C1	0.46	0.58
D	5.33	5.59
E	6.35	6.73
e	2.28 (TYP.)	
H	9.40	10.42
L	0.51	-

● **SOT-223**

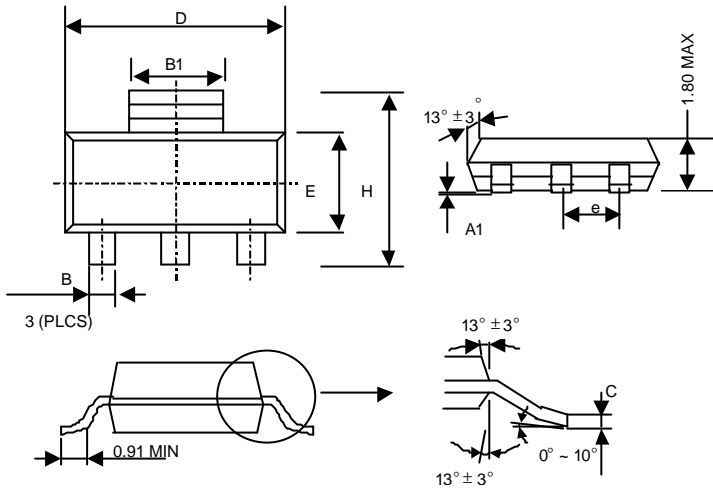

SYMBOL	MIN	MAX
A1	0.02	0.12
B	0.60	0.80
B1	2.90	3.15
C	0.24	0.35
D	6.30	6.80
E	3.30	3.70
e	2.30 (TYP.)	
H	6.70	7.30

● **SOT-223 Marking**

Part No.	Marking
AIC1086CY	1086
AIC1086-28CY	AX28
AIC1086-33CY	AX33
AIC1086-50CY	AX50

● **TO-263 (unit: mm)**

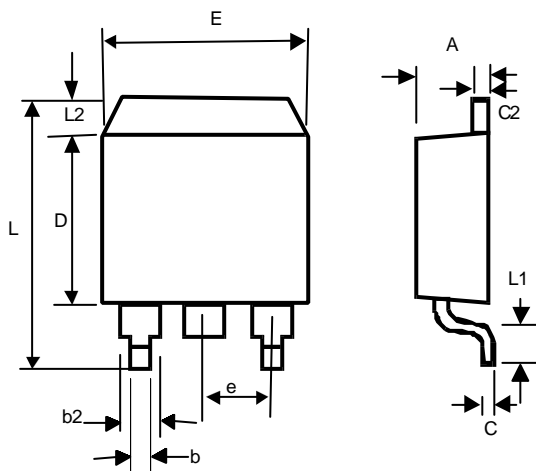

SYMBOL	MIN	MAX
A	4.06	4.83
b	0.50	1.00
b2	1.14	1.40
C	-	0.7
c2	1.14	1.40
D	8.63	9.66
E	9.65	10.29
e	2.54 (TYP.)	
L	14.60	15.88
L1	2.28	2.80
L2	-	1.40