

PNP Silicon AF Transistor

- For general AF applications
- High collector current
- High current gain
- Low collector-emitter saturation voltage
- Complementary types: BC817W, BC818W (NPN)

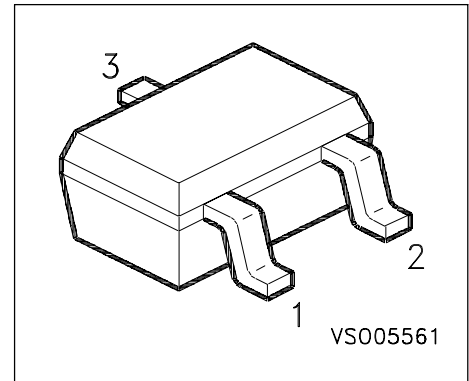

Type	Marking	Ordering Code	Pin Configuration			Package
			1 = B	2 = E	3 = C	
BC 807-16W	5As	Q62702-C2325	1 = B	2 = E	3 = C	SOT-323
BC 807-25W	5Bs	Q62702-C2326	1 = B	2 = E	3 = C	SOT-323
BC 807-40W	5Cs	Q62702-C2327	1 = B	2 = E	3 = C	SOT-323
BC 808-16W	5Es	Q62702-C2328	1 = B	2 = E	3 = C	SOT-323
BC 808-25W	5Fs	Q62702-C2329	1 = B	2 = E	3 = C	SOT-323
BC 808-40W	5Gs	Q62702-C2330	1 = B	2 = E	3 = C	SOT-323

Maximum Ratings

Parameter	Symbol	Values	Unit
Collector-emitter voltage	V_{CEO}		V
BC 807 W		45	
BC 808 W		25	
Collector-base voltage	V_{CBO}		
BC 807 W		50	
BC 808 W		30	
Emitter-base voltage	V_{EBO}	5	
DC collector current	I_C	500	mA
Peak collector current	I_{CM}	1	A
Base current	I_B	100	mA
Total power dissipation, $T_S = 130^\circ\text{C}$	P_{tot}	250	mW
Junction temperature	T_j	150	$^\circ\text{C}$
Storage temperature	T_{stg}	- 65 ... + 150	

Thermal Resistance

Junction ambient ¹⁾	R_{thJA}	≤ 215	K/W
Junction - soldering point	R_{thJS}	≤ 80	

1) Package mounted on pcb 40mm x 40mm x 1.5mm / 0.5cm² Cu

Electrical Characteristics at $T_A=25^\circ\text{C}$, unless otherwise specified

Parameter	Symbol	Values			Unit
		min.	typ.	max.	
DC Characteristics					
Collector-emitter breakdown voltage $I_C = 10 \text{ mA}$, $I_B = 0$, BC 807 W $I_C = 10 \text{ mA}$, $I_B = 0$, BC 808 W	$V_{(BR)CEO}$	45 25	- -	- -	V
Collector-base breakdown voltage $I_C = 10 \mu\text{A}$, $I_B = 0$, BC 807 W $I_C = 10 \mu\text{A}$, $I_B = 0$, BC 808 W	$V_{(BR)CBO}$	50 30	- -	- -	
Base-emitter breakdown voltage $I_E = 10 \mu\text{A}$, $I_C = 0$	$V_{(BR)EBO}$	5	-	-	
Collector-base cutoff current $V_{CB} = 25 \text{ V}$, $T_A = 25^\circ\text{C}$ $V_{CB} = 25 \text{ V}$, $T_A = 150^\circ\text{C}$	I_{CBO}	- -	- -	100 50	nA μA
Emitter cutoff current $V_{EB} = 4 \text{ V}$, $I_C = 0$	I_{EBO}	-	-	100	nA
DC current gain $I_C = 100 \text{ mA}$, $V_{CE} = 1 \text{ V}$, BC ... 16 W $I_C = 100 \text{ mA}$, $V_{CE} = 1 \text{ V}$, BC ... 25 W $I_C = 100 \text{ mA}$, $V_{CE} = 1 \text{ V}$, BC ... 40 W $I_C = 300 \text{ mA}$, $V_{CE} = 1 \text{ V}$, BC ... 16 W $I_C = 300 \text{ mA}$, $V_{CE} = 1 \text{ V}$, BC ... 25 W $I_C = 300 \text{ mA}$, $V_{CE} = 1 \text{ V}$, BC ... 40 W	h_{FE}	100 160 250 60 100 170	160 250 350 - - -	250 400 630 - - -	-
Collector-emitter saturation voltage 1) $I_C = 500 \text{ mA}$, $I_B = 50 \text{ mA}$	V_{CEsat}	-	-	0.7	V
Base-emitter saturation voltage 1) $I_C = 500 \text{ mA}$, $I_B = 50 \text{ mA}$	V_{BEsat}	-	-	1.2	

 1) Pulse test: $t < 300\mu\text{s}$; $D < 2\%$

PNP Silicon AF Transistor
Electrical Characteristics at $T_A=25^\circ\text{C}$, unless otherwise specified

Parameter	Symbol	Values			Unit
		min.	typ.	max.	

AC Characteristics

Transition frequency $I_C = 50 \text{ mA}, V_{CE} = 5 \text{ V}, f = 100 \text{ MHz}$	f_T	-	200	-	MHz
Collector-base capacitance $V_{CB} = 10 \text{ V}, f = 1 \text{ MHz}$	C_{cb}	-	10	-	pF
Emitter-base capacitance $V_{EB} = 0.5 \text{ V}, f = 1 \text{ MHz}$	C_{eb}	-	60	-	

Total power dissipation $P_{tot} = f(T_A^*; T_S)$

* Package mounted on epoxy

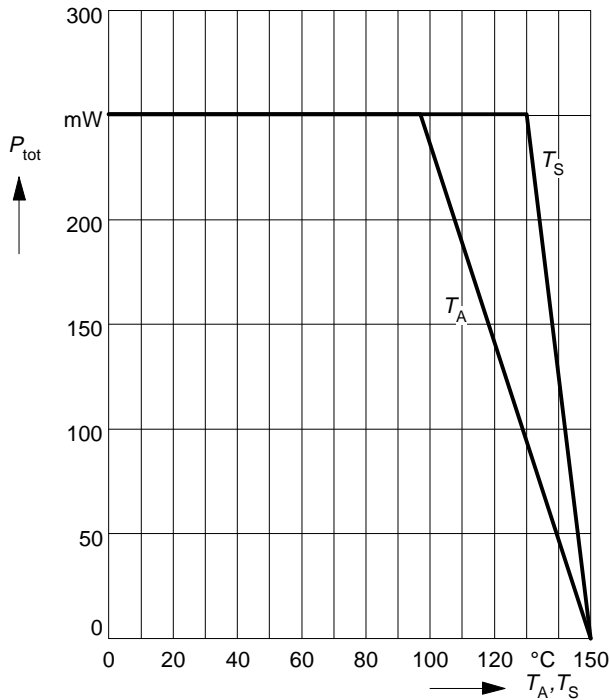

Permissible Pulse Load $R_{thJS} = f(t_p)$

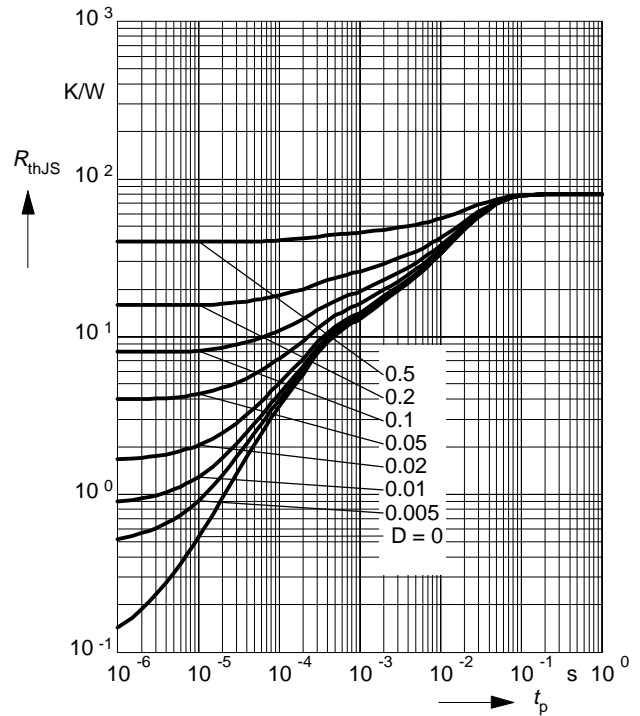

Permissible Pulse Load $P_{totmax} / P_{totDC} = f(t_p)$

Collectot cutoff current $I_{CBO} = f(T_A)$
 $V_{CB} = 60V$

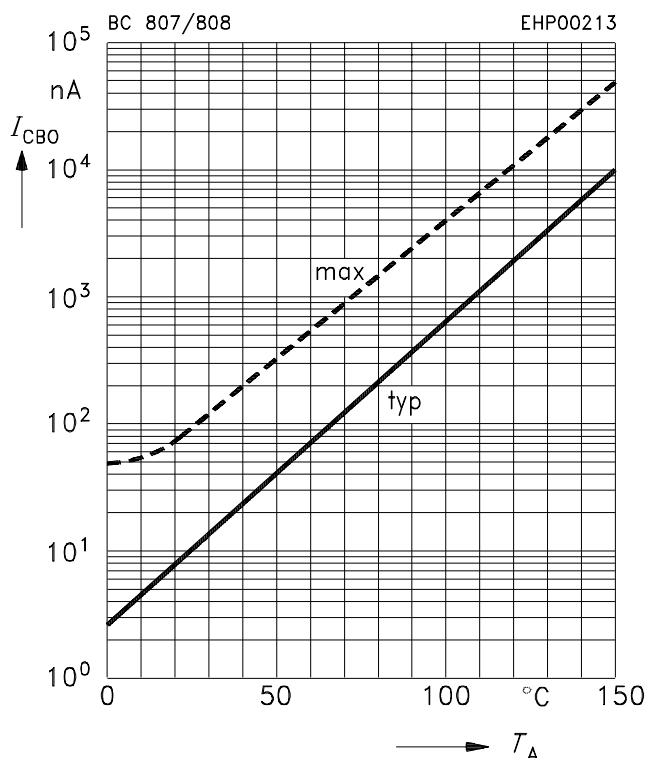
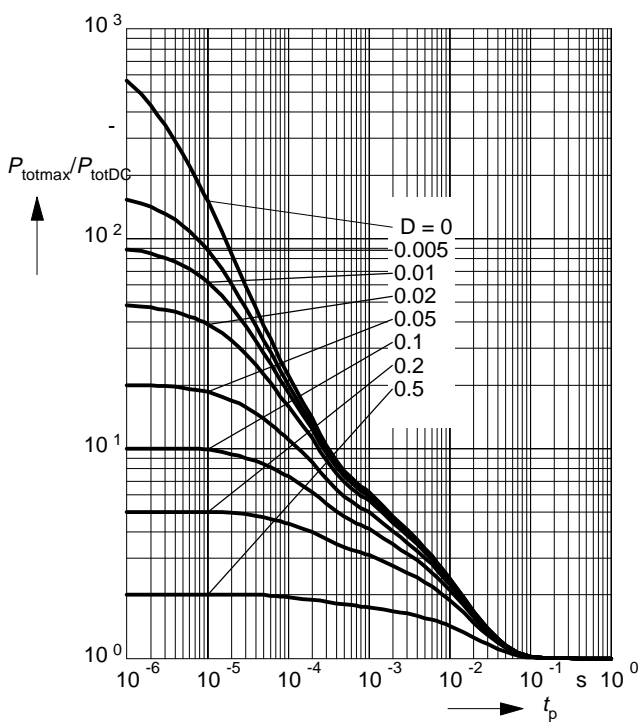

DC current gain $h_{FE} = f(I_C)$

$V_{CE} = 1V$

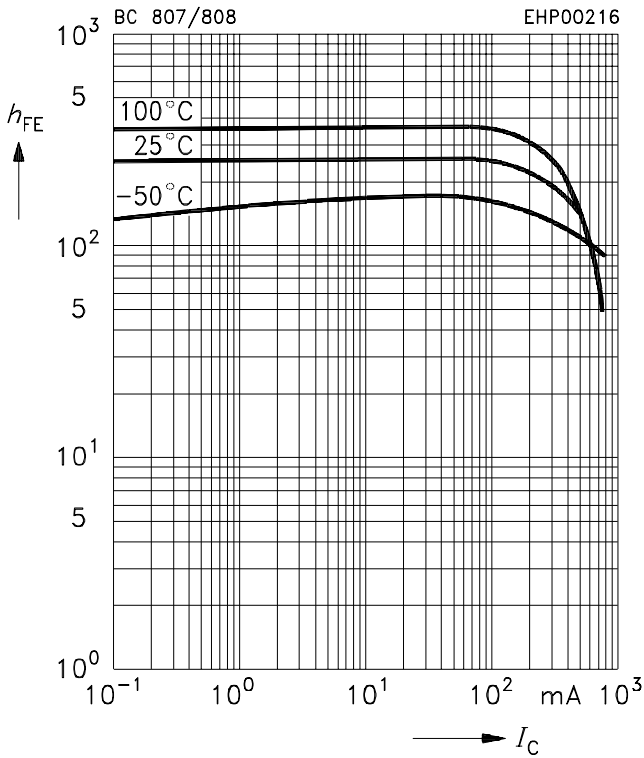

Base-emitter saturation voltage

$I_C = f(V_{BEsat}), h_{FE} = 10$

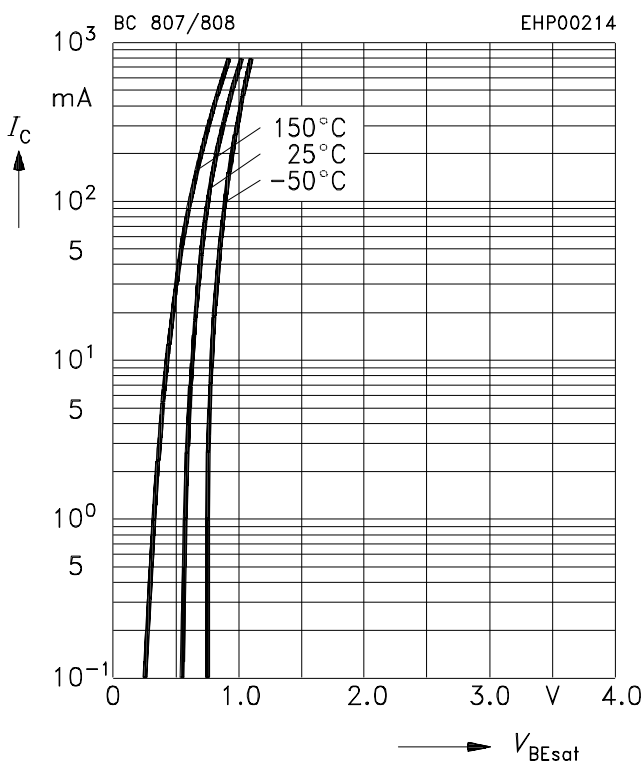

Transition frequency $f_T = f(I_C)$

$V_{CE} = 5V$

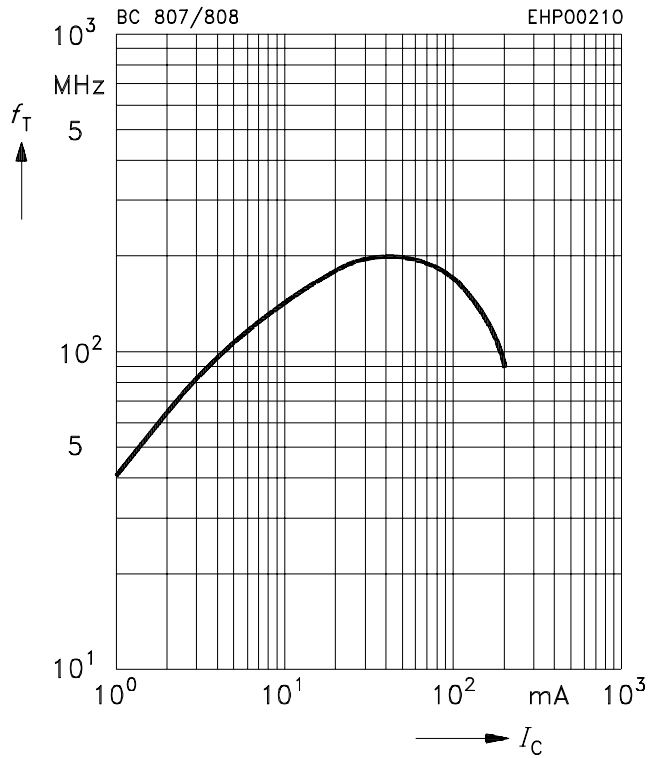

Collector-emitter saturation voltage

$I_C = f(V_{CEsat}), h_{FE} = 10$

