

FEATURES

Matched Offset Voltage
 Matched Offset Voltage Over Temperature
 Matched Bias Currents
 Crosstalk -124 dB at 1 kHz
 Low Bias Current: 35 pA max Warmed Up
 Low Offset Voltage: 500 μ V max
 Low Input Voltage Noise: 2 μ V p-p
 High Slew Rate: 13 V/ μ s
 Low Quiescent Current: 4.5 mA max
 Fast Settling to $\pm 0.01\%$: 3 μ s
 Low Total Harmonic Distortion: 0.0015% at 1 kHz
 Standard Dual Amplifier Pinout
 Available in Hermetic Metal Can Package
 and Chip Form
 MIL-STD-883B Processing Available
 Single Version Available: AD544

PRODUCT DESCRIPTION

The AD644 is a pair of matched high speed monolithic FET input operational amplifiers fabricated with the most advanced bipolar, JFET and laser-trimming technologies. The AD644 offers matched bias currents that are significantly lower than currently available monolithic dual BiFET operational amplifiers: 35 pA max, matched to 25 pA for the AD644K and L, 75 pA max matched to 35 pA for the AD644J and S. In addition, the offset voltage is laser trimmed to less than 0.5 mV, and matched to 0.25 mV for the AD644L, 1.0 mV and matched to 0.5 mV for the AD644K, utilizing Analog Devices' laser-wafer trimming (LWT) process.

The tight matching and temperature tracking between the operational amplifiers is achieved by ion-implanted JFETs and laser-wafer trimming. Ion-implantation permits the fabrication of precision, matched JFETs on a monolithic bipolar chip. This process optimizes the ability to produce matched amplifiers which have lower initial bias currents than other popular BiFET op amps. Laser-wafer trimming each amplifier's input offset voltage assures tight initial match and superior IC processing guarantees offset voltage tracking over the temperature range.

The AD644 is recommended for applications in which both excellent ac and dc performance is required. The matched amplifiers provide a low cost solution to true wideband instrumentation amplifiers, low dc drift active filters and output amplifiers for four quadrant multiplying D/A converters such as the AD7541, 12-bit CMOS DAC.

The AD644 is available in four versions: the "J", "K" and "L" are specified over the 0°C to +70°C temperature range and the "S" over the -55°C to +125°C operating temperature range.

REV. A

Information furnished by Analog Devices is believed to be accurate and reliable. However, no responsibility is assumed by Analog Devices for its use, nor for any infringements of patents or other rights of third parties which may result from its use. No license is granted by implication or otherwise under any patent or patent rights of Analog Devices.

PIN CONFIGURATION

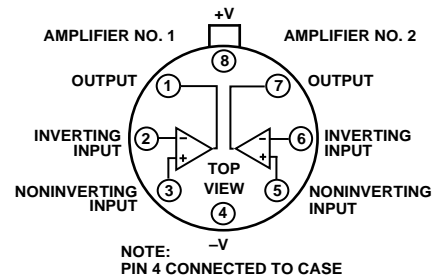

All devices are packaged in the hermetically sealed, TO-99 metal can or available in chip form.

PRODUCT HIGHLIGHTS

1. The AD644 has tight side to side matching specifications to ensure high performance without matching individual devices.
2. Analog Devices, unlike some manufacturers, specifies each device for the maximum bias current at either input in the warmed-up condition, thus assuring the user that the AD644 will meet its published specifications in actual use.
3. Laser-wafer-trimming reduces offset voltage to as low as 0.5 mV max matched side to side to 0.25 mV (AD644L), thus eliminating the need for external nulling.
4. Improved bipolar and JFET processing on the AD644 result in the lowest matched bias current available in a high speed monolithic FET op amp.
5. Low voltage noise (2 μ V p-p) and high open loop gain enhance the AD644's performance as a precision op amp.
6. The high slew rate (13.0 V/ μ s) and fast settling time to 0.01% (3.0 μ s) make the AD644 ideal for D/A, A/D, sample-and-hold circuits and dual high speed integrators.
7. Low harmonic distortion (0.0015%) and low crosstalk (-124 dB) make the AD644 an ideal choice for stereo audio applications.
8. The standard dual amplifier pin out allows the AD644 to replace lower performance duals without redesign.
9. The AD644 is available in chip form.

AD644—SPECIFICATIONS (@ +25°C and $V_S = \pm 15$ V dc)

Model	AD644J			AD644K			AD644L			AD644S			Units
	Min	Typ	Max	Min	Typ	Max	Min	Typ	Max	Min	Typ	Max	
OPEN LOOP GAIN $V_O = \pm 10$ V, $R_L \geq 2$ k Ω T_{MIN} to T_{MAX} , $R_L = 2$ k Ω	30,000 20,000			50,000 40,000			50,000 40,000			50,000 20,000			V/V V/V
OUTPUT CHARACTERISTICS Voltage @ $R_L = 2$ k Ω , T_{MIN} to T_{MAX} Voltage @ $R_L = 10$ k Ω , T_{MIN} to T_{MAX} Short Circuit Current	± 10	± 12		± 10	± 12		± 10	± 12		± 10	± 12		V V mA
FREQUENCY RESPONSE Unity Gain Small Signal Full Power Response Slew Rate, Unity Gain Total Harmonic Distortion		2.0 200 8.0			2.0 200 13.0			2.0 200 13.0			2.0 200 13.0		MHz kHz V/ μ s %
INPUT OFFSET VOLTAGE ¹ Initial Offset Input Offset Voltage T_{MIN} to T_{MAX} Input Offset Voltage vs. Supply, T_{MIN} to T_{MAX}			2.0			1.0			0.5			1.0	mV mV mV μ V/V
INPUT BIAS CURRENT ² Either Input Offset Current		10 10	75		10 5	35		10 5	35		10 5	35	pA pA
MATCHING CHARACTERISTICS ³ Input Offset Voltage Input Offset Voltage T_{MIN} to T_{MAX} Input Bias Current Crosstalk			1.0			0.5			0.25			0.5	mV mV pA dB
INPUT IMPEDANCE Differential Common Mode		$10^{12} _6$ $10^{12} _3$			$10^{12} _6$ $10^{12} _3$			$10^{12} _6$ $10^{12} _3$			$10^{12} _6$ $10^{12} _3$		M Ω pF M Ω pF
INPUT VOLTAGE RANGE Differential ⁴ Common Mode Common-Mode Rejection		± 20 ± 10	± 12		± 20 ± 10	± 12		± 20 ± 10	± 12		± 20 ± 10	± 12	V V dB
INPUT NOISE Voltage 0.1 Hz to 10 Hz $f = 10$ Hz $f = 100$ Hz $f = 1$ kHz $f = 10$ kHz		2 35 22 18 16			2 35 22 18 16			2 35 22 18 16			2 35 22 18 16		μ V p-p nV/ \sqrt{Hz} nV/ \sqrt{Hz} nV/ \sqrt{Hz} nV/ \sqrt{Hz}
POWER SUPPLY Rated Performance Operating Quiescent Current		± 5	± 15 ± 18		± 5	± 15 ± 18		± 5	± 15 ± 18		± 5	± 15 ± 18	V V mA
TEMPERATURE RANGE Operating, Rated Performance Storage		0 -65	+70 +150		0 -65	+70 +150		0 -65	+70 +150		-55 -65	+125 +150	$^{\circ}$ C $^{\circ}$ C
PACKAGE OPTION TO-99 Style (H-08B) Chips		AD644JH AD644JChips			AD644KH AD644KChips			AD644LH			AD644SH AD644SChips		

NOTES

¹Input Offset Voltage specifications are guaranteed after 5 minutes of operation at $T_A = +25^{\circ}$ C.

²Bias Current specifications are guaranteed at maximum at either input after 5 minutes of operation at $T_A = +25^{\circ}$ C. For higher temperatures, the current doubles every 10° C.

³Matching is defined as the difference between parameters of the two amplifiers.

⁴Defined as voltage between inputs, such that neither exceeds ± 10 V from ground.

Specifications shown in **boldface** are tested on all production units at final electrical test. Results from those tests are used to calculate outgoing quality levels. All min and max specifications are guaranteed, although only those shown in **boldface** are tested on all production units.

Specifications subject to change without notice.

METALIZATION PHOTOGRAPH

Dimensions shown in inches and (mm).

Contact factory for latest dimensions.

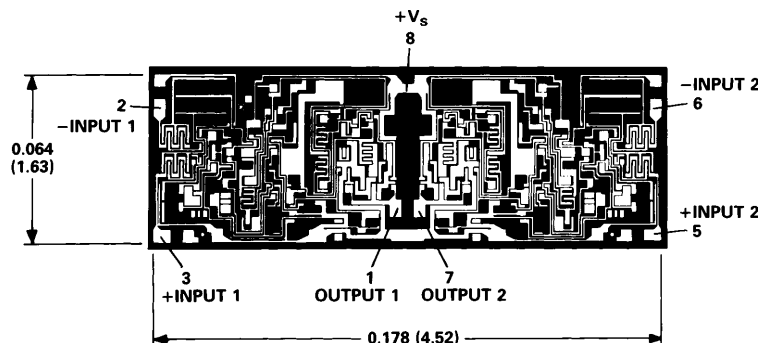

Typical Characteristics-AD644

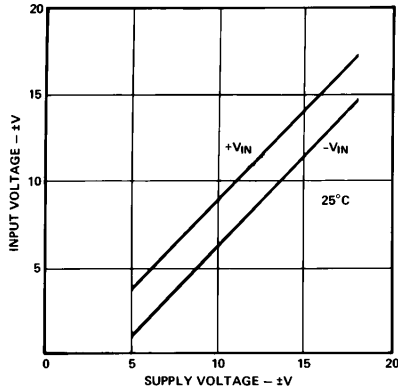

Figure 1. Input Voltage Range vs. Supply Voltage

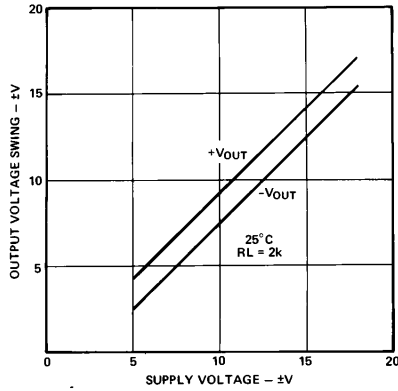

Figure 2. Output Voltage Swing vs. Supply Voltage

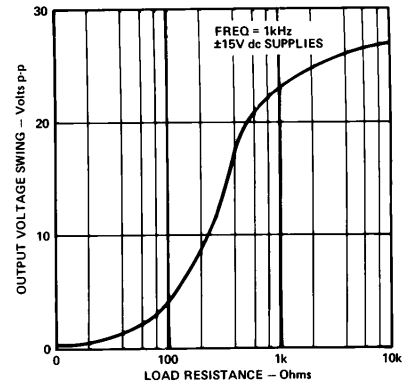

Figure 3. Output Voltage Swing vs. Load Resistance

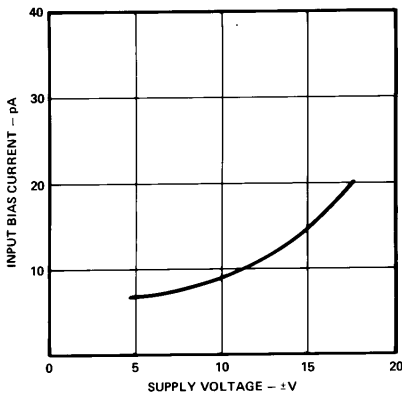

Figure 4. Input Bias Current vs. Supply Voltage

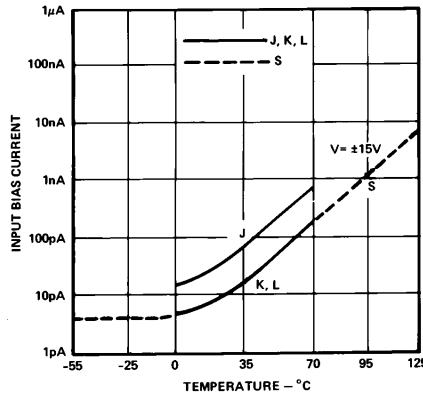

Figure 5. Input Bias Current vs. Temperature

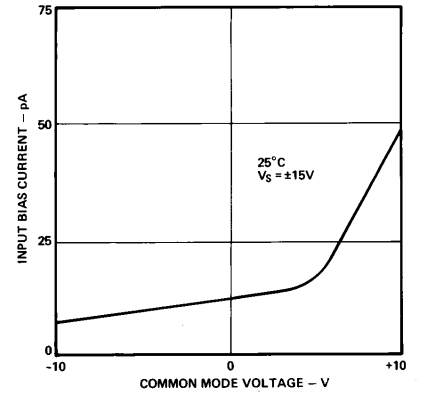

Figure 6. Input Bias Current vs. CMV

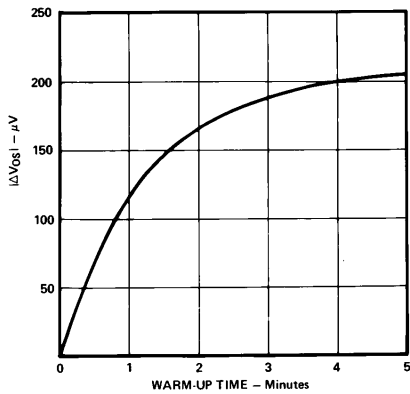

Figure 7. Change in Offset Voltage vs. Warm-Up Time

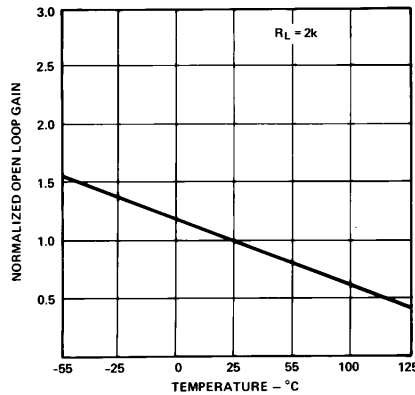

Figure 8. Open Loop Gain vs. Temperature

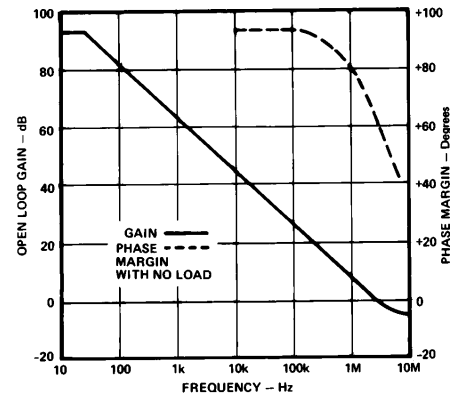

Figure 9. Open Loop Frequency Response

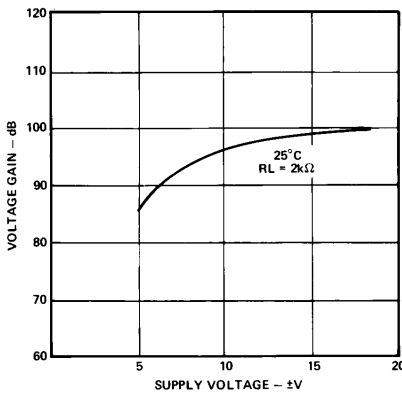

Figure 10. Open Loop Voltage Gain vs. Supply Voltage

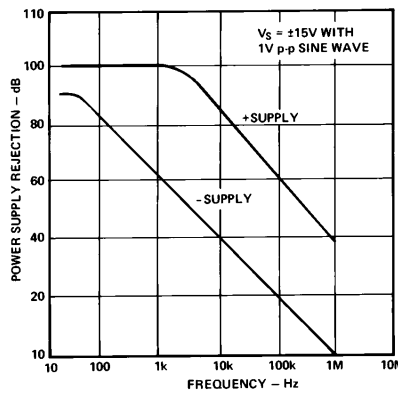

Figure 11. Power Supply Rejection vs. Frequency

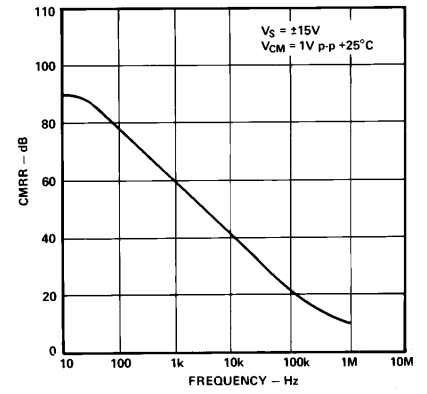

Figure 12. Common Mode Rejection Ratio vs. Frequency

AD644

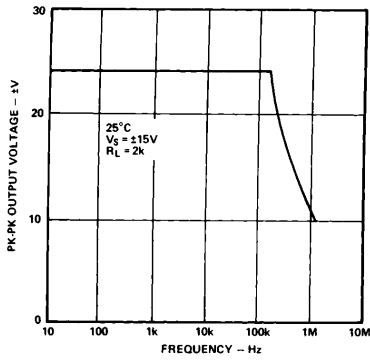

Figure 13. Large Signal Frequency Response

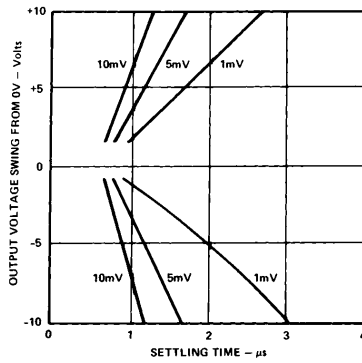

Figure 14. Output Swing and Error vs. Settling Time (Circuit of Figure 23a)

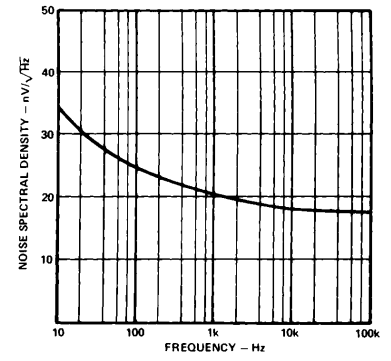

Figure 15. Noise Spectral Density

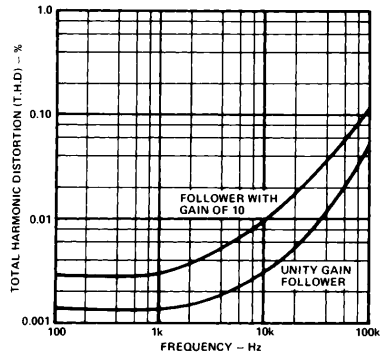

Figure 16. Total Harmonic Distortion vs. Frequency

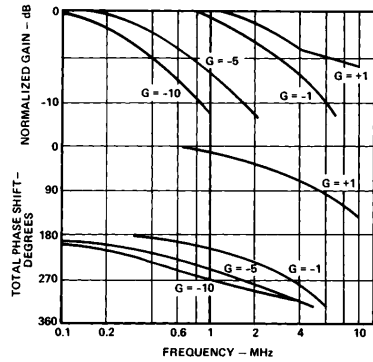

Figure 17. Closed Loop Gain & Phase vs. Frequency

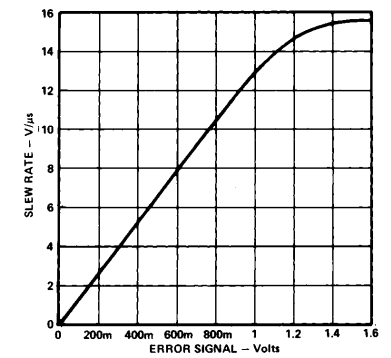
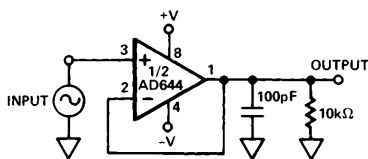
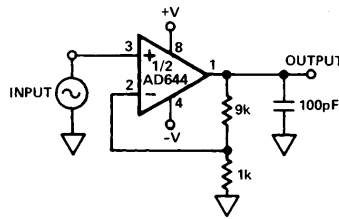

Figure 18. Slew Rate vs. Error Signal



a. Unity Gain Follower



b. Follower with Gain = 10

Figure 19. T.H.D. Test Circuits

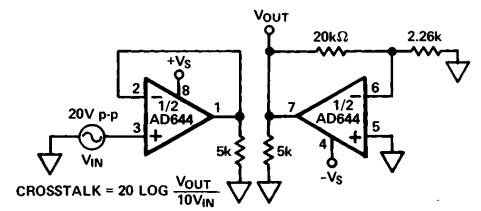

Figure 20. Crosstalk Test Circuit

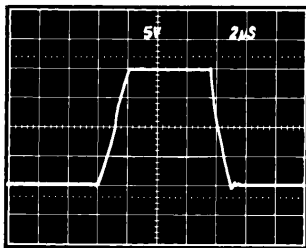

Figure 21a. Unity Gain Follower Pulse Response (Large Signal)

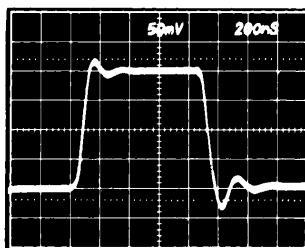

Figure 21b. Unity Gain Follower Pulse Response (Small Signal)

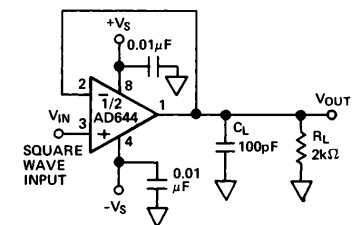

Figure 21c. Unity Gain Follower

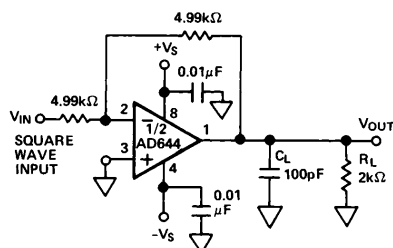

Figure 22a. Unity Gain Inverter

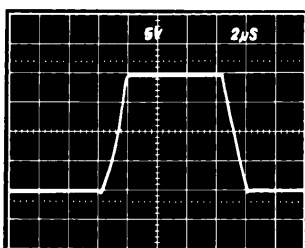

Figure 22b. Unity Gain Inverter Pulse Response (Large Signal)

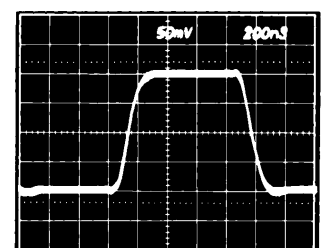

Figure 22c. Unity Gain Inverter Pulse Response (Small Signal)

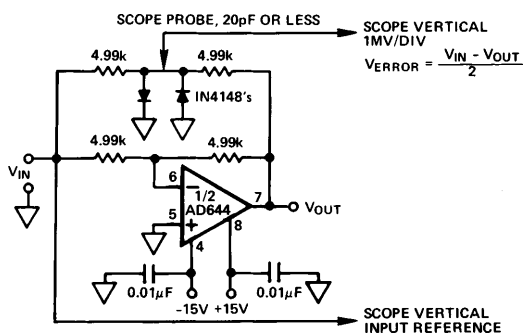

Figure 23a. Settling Time Test Circuit

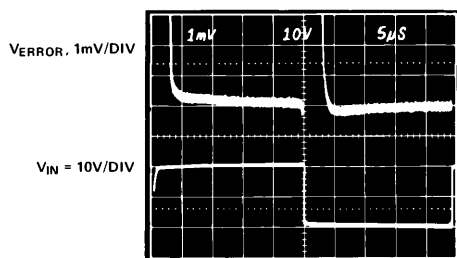

Figure 23b. Settling Characteristic Detail

The fast settling time (3.0 μ s to 0.01% for 20 V p-p step) and low offset voltage make the AD644 an excellent choice as an output amplifier for current output D/A converters such as the AD7541. The upper trace of the oscilloscope photograph of Figure 23b shows the settling characteristics of the AD644. The lower trace represents the input to Figure 23a. The AD644 has been designed for fast settling to 0.01%, however, feedback components, circuit layout and circuit design must be carefully considered to obtain the optimum settling time.

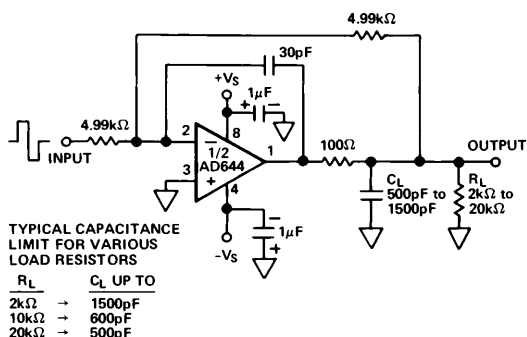
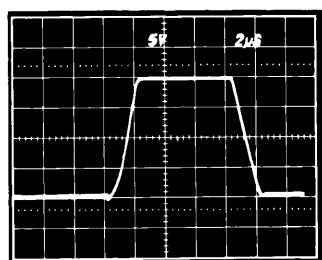

Figure 24. Circuit for Driving a Large Capacitive Load



Transient Response $R_L = 2k\Omega$ $C_L = 500pF$

The circuit in Figure 24 employs a 100 Ω isolation resistor which enables the amplifier to drive capacitive loads exceeding 500 pF; the resistor effectively isolates the high frequency feedback from the load and stabilizes the circuit. Low frequency feedback is returned to the amplifier summing junction via the

low pass filter formed by the 100 Ω series resistor and the load capacitance, C_L .

The low input bias current (35 pA), low noise, high slew rate and high bandwidth characteristics of the AD644 make it suitable for electrometer applications such as photodiode preamplifiers and picoampere current-to-voltage converters. The use of guarding techniques in printed circuit board layout and construction is critical for achieving the ultimate in low leakage performance that the AD644 can deliver. The input guarding scheme shown in Figure 25 will minimize leakage as much as possible. The same layout should be used on both sides of a double side board. The guard ring is connected to a low impedance potential at the same level as the inputs. High impedance signal lines should not be extended for any unnecessary length on a printed circuit; to minimize noise and leakage, such conductors should be replaced by rigid shielded cables.

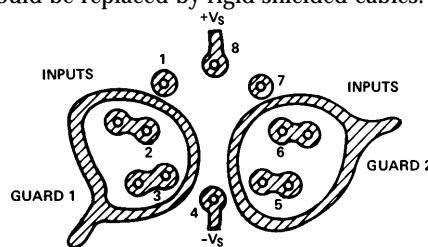

Figure 25. Board Layout for Guarding Inputs

INPUT PROTECTION

The AD644 is guaranteed for a maximum safe input potential equal to the power supply potential. The input stage design also allows differential input voltages of up to ± 1 volt while maintaining the full differential input resistance of $10^{12} \Omega$. This makes the AD644 suitable for comparator situations employing a direct connection to high impedance source.

Many instrumentation situations, such as flame detectors in gas chromatographs, involve measurement of low level currents from high voltage sources. In such applications, a sensor fault condition may apply a very high potential to the input of the current-to-voltage converting amplifier. This possibility necessitates some form of input protection. Many electrometer type devices, especially CMOS designs, can require elaborate Zener protection schemes which often compromise overall performance. The AD644 requires input protection only if the source is not current-limited, and as such is similar to many JFET-input designs. The failure mode would be overheating from excess current rather than voltage breakdown. If the source is not current-limited, all that is required is a resistor in series with the affected input terminal so that the maximum overload current is 1.0 mA (for example, 100 k Ω for a 100 volt overload). This simple scheme will cause no significant reduction in performance and give complete overload protection. Figure 26 shows proper connections.

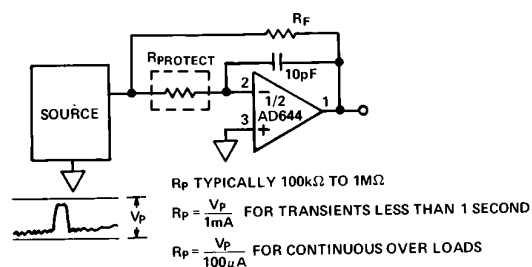

Figure 26. AD644 Input Protection

AD644

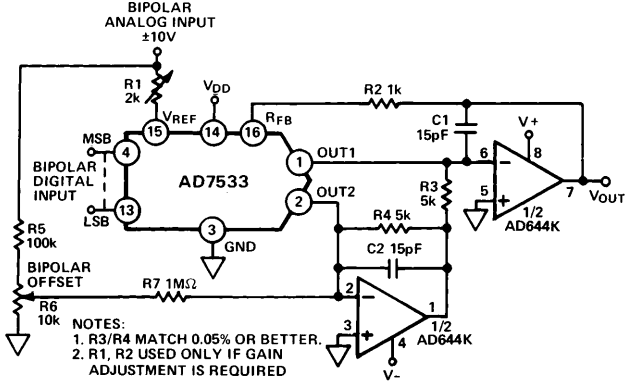

Figure 27a. AD644 Used as DAC Output Amplifiers

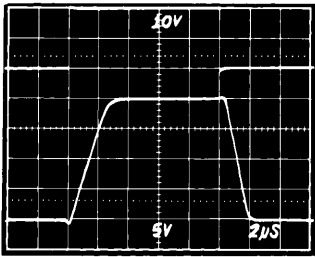

Figure 27b. Large Signal Response

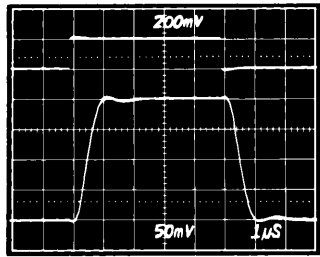

Figure 27c. Small Signal Response

Figure 27a illustrates the 10-bit digital-to-analog converter, AD7533, connected for bipolar operation. Since the digital input can accept bipolar numbers and V_{REF} can accept a bipolar analog input, the circuit can perform a 4-quadrant multiplying function. The photos exhibit the response to a step input at V_{REF} . Figure 27b is the large signal response and Figure 27c is the small signal response.

The output impedance of a CMOS DAC varies with the digital word thus changing the noise gain of the amplifier circuit. The effect will cause a nonlinearity the magnitude of which is dependent on the offset voltage of the amplifier. The AD644K with trimmed offset will minimize the effect. The Schottky protection diodes recommended for use with many older CMOS DACs are not required when using the AD644.

ACTIVE FILTERS

Literature on active filter techniques and characteristics based on operational amplifiers is readily available. The successful application of an active filter however, depends on the component selection to achieve the desired performance. The AD644 is recommended for filters in medical, instrumentation, data acquisition and audio applications, because of its high gain bandwidth figure, symmetrical slewing, low noise, and low 1 offset voltage.

The state variable filter (Figure 28) is stable, easily tuned and is independent of circuit Q and gain. The use of the AD644 with

its low input bias current simplifies the resistor (R3, R4) selection for the passband center frequency, circuit Q and voltage gain.

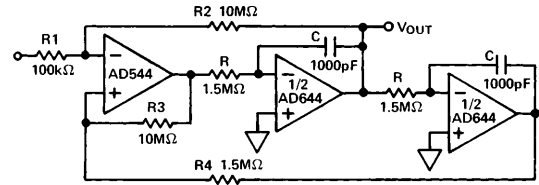

$$f_0 = \text{CENTER FREQUENCY} = 1/2 \pi R_C C$$

$$Q_0 = \text{QUALITY FACTOR} = \frac{R_1 + R_2}{2R_1}$$

$$H_0 = \text{GAIN AT RESONANCE} = R_2/R_1$$

$$R_3 = R_4 \approx 10^8/f_0$$

Q_0 , IS ADJUSTABLE BY VARYING R2
 f_0 , IS ADJUSTABLE BY VARYING R OR C

Figure 28. Band Pass State Variable Filter

The sample and hold circuit, shown in Figure 29 is suitable for use with 8-bit A/D converters. The acquisition time using a 3900 pF capacitor and fast CMOS SPST (ADG200) switch is 15 μ s.

The droop rate is very low 25×10^{-9} V/ μ s due to the low input bias currents of the AD644. Care should be taken to minimize leakage paths. Leakages around the hold capacitor will increase the droop rate and degrade performance.

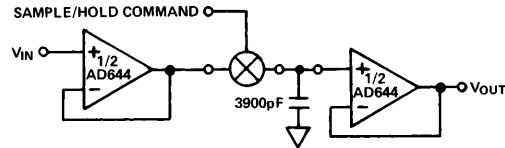

Figure 29. Sample and Hold Circuit

The AD644 in the circuit of Figure 30 provides highly accurate signal conditioning with high frequency input signals. It provides an offset voltage drift of 10 μ V/ $^\circ$ C, CMRR of 80 dB over the range of dc to 10 kHz and a bandwidth of 200 kHz (-3 dB) at 1 V p-p output. The circuit of Figure 30 can be configured for a gain range of 2 to 1000 with a typical nonlinearity of 0.01% at a gain of 10.

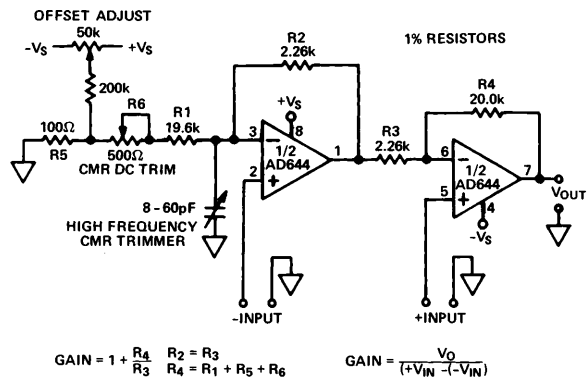

Figure 30. Wide Bandwidth Instrumentation Amplifier

OUTLINE DIMENSIONS

Dimensions shown in inches and (mm).

