

SILICON POWER TRANSISTOR  
**NEL200101-24**

NPN SILICON EPITAXIAL TRANSISTOR  
 L Band Power Amplifier

DESCRIPTION AND APPLICATIONS

NEL2001012-24 of NPN epitaxial microwave power transistors is designed for 1.8-2 GHz PHS/PCN/PCS base station applications.

It incorporates emitter ballast resistors, gold metallizations and offers a high degree of reliability.

FEATURES

- High Linear Power and Gain
- Low Internal Modulation Distortion
- High Reliability Gold Metallization
- Emitter Ballasting
- 24 V Operation

OUTLINE DIMENSIONS (Unit: mm)

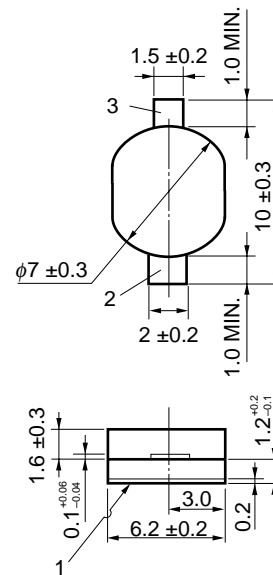

1 - EMITTER  
 2 - BASE  
 3 - COLLECTOR

ABSOLUTE MAXIMUM RATING (T<sub>A</sub> = 25 °C)

PARAMETER	SYMBOL	SPECIFIED CONDITION	RATINGS	UNIT
Collector to Base Voltage	V <sub>CBO</sub>		45	V
Collector to Emitter Voltage	V <sub>CER</sub>	R = 10 Ω	30	V
Emitter to Base Voltage	V <sub>EBO</sub>		3	V
Collector to Emitter Voltage	V <sub>CEO</sub>		18	V
Collector Current	I <sub>c</sub>		0.5	A
Power Dissipation	P <sub>T</sub>		7.4	W
Thermal Resistance	R <sub>th(j-c)</sub>		23.6	°C/W
Junction Temperature	T <sub>j</sub>		200	°C
Storage Temperature	T <sub>stg</sub>		-65 to 150	°C

**ELECTRICAL CHARACTERISTICS (T<sub>A</sub> = 25 °C)**

PARAMETER	SYMBOL	SPECIFIED CONDITION	MIN.	TYP.	MAX.	UNIT
Collector to Emitter Cutoff Current	I <sub>CES</sub>	V <sub>CE</sub> = 24 V			1	mA
Collector to Emitter Voltage (Base to Emitter Resistor = 10 Ω)	V <sub>CER</sub>	I <sub>C</sub> = 1 mA, R = 10 Ω	30	85		V
Collector to Emitter Voltage (Open Base)	V <sub>CEO</sub>	I <sub>C</sub> = 1 mA	18	22		V
Collector to Base Voltage (Open Emitter)	V <sub>CBO</sub>	I <sub>C</sub> = 1 mA	45	85		V
Emitter to Base Voltage (Open Collector)	V <sub>EBO</sub>	I <sub>C</sub> = 3 mA	3	4.4		V
DC Forward Current Gain	h <sub>FE</sub>	V <sub>CE</sub> = 5 V, I <sub>C</sub> = 0.1 A	30	100	150	
Output Capacitance	C <sub>ob</sub>	V <sub>CE</sub> = 24 V, f = 1 MHz		3		pF

PERFORMANCE SPECIFICATIONS (T<sub>A</sub> = 25 °C)

CLASS AB OPERATION

PARAMETER	SYMBOL	SPECIFIED CONDITION	MIN.	TYP.	MAX.	UNIT
Output Power	P <sub>ldB</sub>	f = 1.97 GHz, I <sub>q</sub> = 20 mA, V <sub>CC</sub> = 24 V, CLASS AB		2.5		W
Collector Efficiency	η <sub>C</sub>	f = 1.97 GHz, P <sub>out</sub> = P <sub>ldB</sub> , I <sub>q</sub> = 20 mA, V <sub>CC</sub> = 24 V, CLASS AB		54		%
Linear Gain	GL	f = 1.97 GHz, P <sub>in</sub> = 0.04 W, I <sub>q</sub> = 20 mA, V <sub>CC</sub> = 24 V, CLASS AB		8.8		dB
3rd Order Intermodulation	IM <sub>3</sub>	f = 1.97 GHz, Δf = 100 kHz, 2 W PEP, V <sub>CC</sub> = 24 V, I <sub>q</sub> = 20 mA, CLASS AB		-33		dBc

CLASS A OPERATION

PARAMETER	SYMBOL	SPECIFIED CONDITION	MIN.	TYP.	MAX.	UNIT
Output Power	P <sub>ldB</sub>	f = 1.97 GHz, I <sub>q</sub> = 100 mA, V <sub>CC</sub> = 20 V, CLASS A	0.5	0.7		W
Collector Efficiency	η <sub>C</sub>	f = 1.97 GHz, P <sub>out</sub> = P <sub>ldB</sub> , I <sub>q</sub> = 100 mA, V <sub>CC</sub> = 20 V, CLASS A		30		%
Linear Gain	GL	f = 1.97 GHz, P <sub>in</sub> = 0.01 W, I <sub>q</sub> = 100 mA, V <sub>CC</sub> = 20 V, CLASS A		10.8		dB
3rd Order Intermodulation	IM <sub>3</sub>	f = 1.97 GHz, Δf = 100 kHz, 0.5 W PEP, V <sub>CC</sub> = 20 V, I <sub>q</sub> = 100 mA, CLASS A		-36		dBc

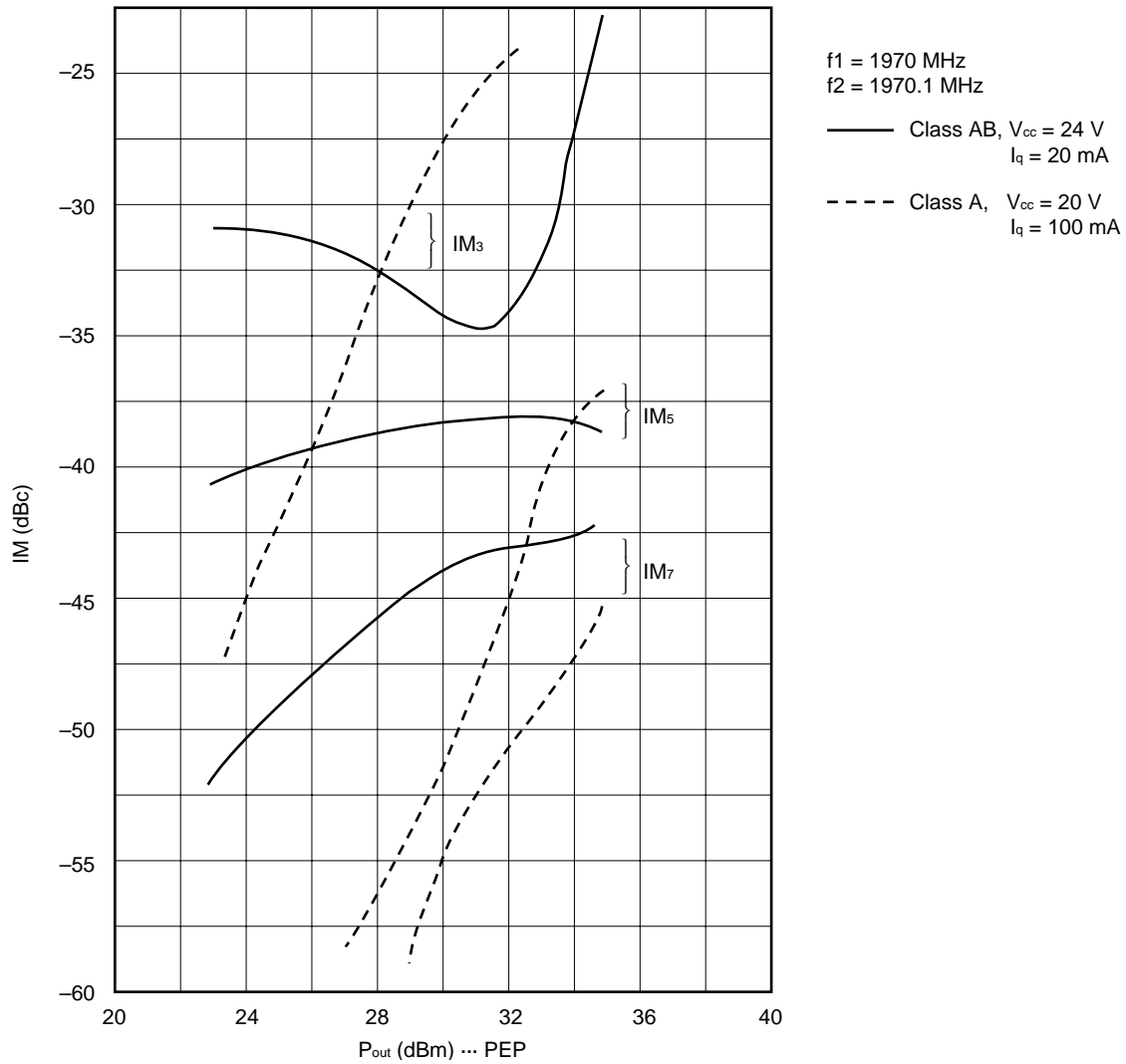
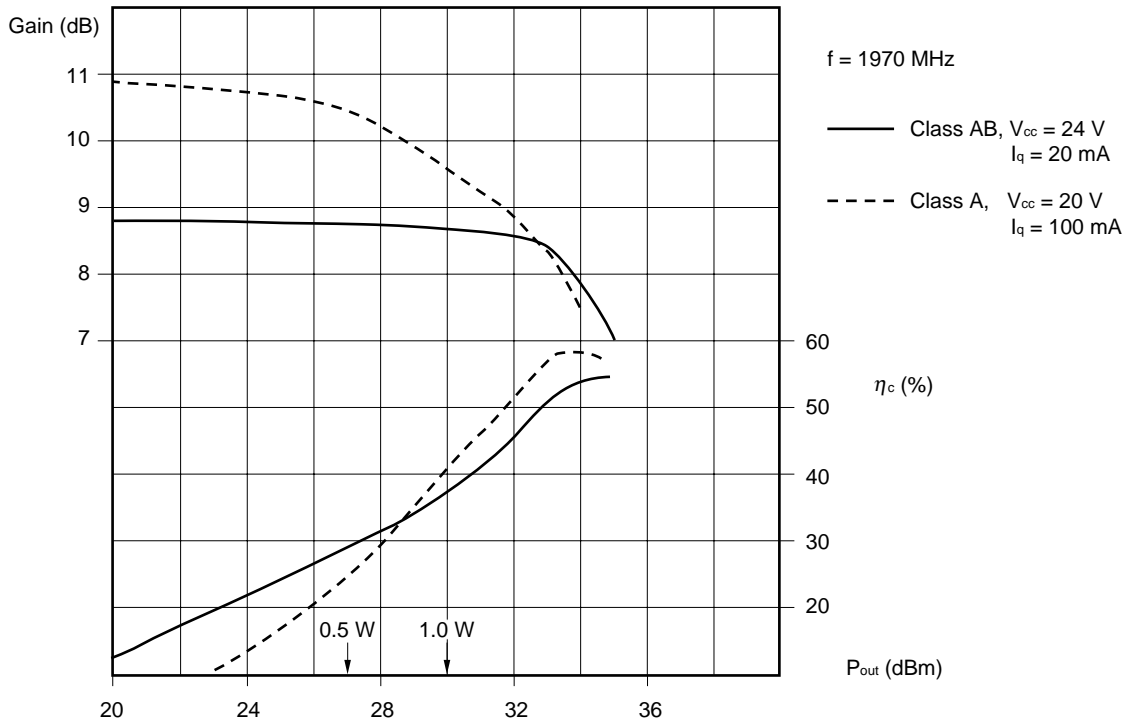

**S-PARAMETER**

NEL2001 Class A

V<sub>CC</sub> = 20 V, I<sub>cq</sub> = 0.1 A

FREQUENCY GHz	S <sub>11</sub>		S <sub>12</sub>		S <sub>21</sub>		S <sub>22</sub>	
	MAG	ANG (DEG)	MAG	ANG (DEG)	MAG	ANG (DEG)	MAG	ANG (DEG)
1.70	0.75	130	0.07	-7	2.08	18	0.41	-155
1.71	0.75	129	0.07	-6	2.07	18	0.41	-155
1.72	0.74	129	0.07	-6	2.06	18	0.42	-156
1.73	0.74	128	0.08	-7	2.05	17	0.42	-156
1.74	0.74	128	0.08	-7	2.04	16	0.42	-156
1.75	0.74	127	0.08	-7	2.02	16	0.42	-156
1.76	0.74	127	0.08	-6	2.01	16	0.42	-156
1.77	0.74	127	0.08	-7	2.00	15	0.42	-156
1.78	0.74	126	0.08	-7	1.99	15	0.42	-157
1.79	0.74	126	0.08	-8	1.98	14	0.42	-157
1.80	0.74	125	0.08	-8	1.97	14	0.43	-157
1.81	0.74	125	0.07	-9	1.95	13	0.43	-157
1.82	0.74	124	0.07	-10	1.94	13	0.43	-158
1.83	0.74	124	0.08	-7	1.93	12	0.43	-158
1.84	0.74	124	0.08	-6	1.93	12	0.43	-158
1.85	0.75	124	0.08	-6	1.92	12	0.43	-158
1.86	0.75	123	0.08	-8	1.91	11	0.43	-158
1.87	0.75	122	0.08	-9	1.89	10	0.43	-159
1.88	0.75	122	0.08	-9	1.88	10	0.43	-159
1.89	0.75	122	0.08	-10	1.87	10	0.43	-159
1.90	0.75	121	0.08	-9	1.86	9	0.43	-159
1.91	0.75	121	0.08	-9	1.86	9	0.43	-159
1.92	0.75	120	0.08	-10	1.85	8	0.44	-159
1.93	0.75	120	0.08	-10	1.84	8	0.44	-160
1.94	0.75	119	0.08	-10	1.83	8	0.44	-160
1.95	0.75	119	0.08	-10	1.81	7	0.44	-160
1.96	0.75	119	0.08	-10	1.80	7	0.44	-161
1.97	0.75	118	0.08	-9	1.80	7	0.44	-161
1.98	0.75	118	0.08	-9	1.80	6	0.44	-161
1.99	0.75	118	0.08	-10	1.80	6	0.44	-161
2.00	0.75	117	0.08	-11	1.80	5	0.45	-161

NEL2001 Class AB

V<sub>CC</sub> = 24 V, I<sub>cq</sub> = 0.02 A

FREQUENCY GHz	S <sub>11</sub>		S <sub>12</sub>		S <sub>21</sub>		S <sub>22</sub>	
	MAG	ANG (DEG)	MAG	ANG (DEG)	MAG	ANG (DEG)	MAG	ANG (DEG)
1.70	0.78	131	0.07	-11	1.56	9	0.53	-132
1.71	0.78	130	0.06	-11	1.53	9	0.53	-132
1.72	0.78	130	0.06	-11	1.51	9	0.53	-133
1.73	0.78	130	0.07	-10	1.51	8	0.53	-133
1.74	0.77	129	0.07	-11	1.52	8	0.53	-133
1.75	0.77	129	0.07	-11	1.51	7	0.53	-134
1.76	0.77	128	0.07	-11	1.50	6	0.53	-134
1.77	0.77	128	0.06	-11	1.48	6	0.54	-134
1.78	0.77	128	0.06	-11	1.46	6	0.54	-135
1.79	0.77	127	0.06	-11	1.46	5	0.54	-135
1.80	0.77	127	0.06	-11	1.46	5	0.54	-135
1.81	0.78	127	0.07	-13	1.46	4	0.54	-135
1.82	0.78	126	0.07	-14	1.45	3	0.55	-136
1.83	0.78	126	0.07	-14	1.43	3	0.55	-136
1.84	0.77	125	0.07	-13	1.41	3	0.55	-137
1.85	0.77	125	0.07	-13	1.41	2	0.55	-137
1.86	0.78	124	0.07	-12	1.41	2	0.55	-137
1.87	0.78	124	0.07	-12	1.41	1	0.55	-138
1.88	0.78	123	0.07	-12	1.40	0	0.55	-138
1.89	0.78	123	0.07	-12	1.38	0	0.55	-138
1.90	0.78	122	0.07	-12	1.37	0	0.55	-139
1.91	0.78	122	0.07	-12	1.36	0	0.56	-139
1.92	0.78	121	0.07	-13	1.37	-1	0.56	-139
1.93	0.78	121	0.07	-13	1.37	-2	0.56	-140
1.94	0.78	121	0.07	-13	1.35	-2	0.56	-140
1.95	0.78	120	0.07	-13	1.34	-3	0.56	-140
1.96	0.78	120	0.07	-12	1.32	-3	0.56	-141
1.97	0.78	120	0.07	-12	1.32	-3	0.56	-141
1.98	0.78	119	0.07	-12	1.32	-3	0.56	-141
1.99	0.78	119	0.07	-12	1.33	-4	0.57	-142
2.00	0.78	118	0.07	-12	1.34	-5	0.57	-142

NEL200101-24  $Z_{in}/Z_{out}$

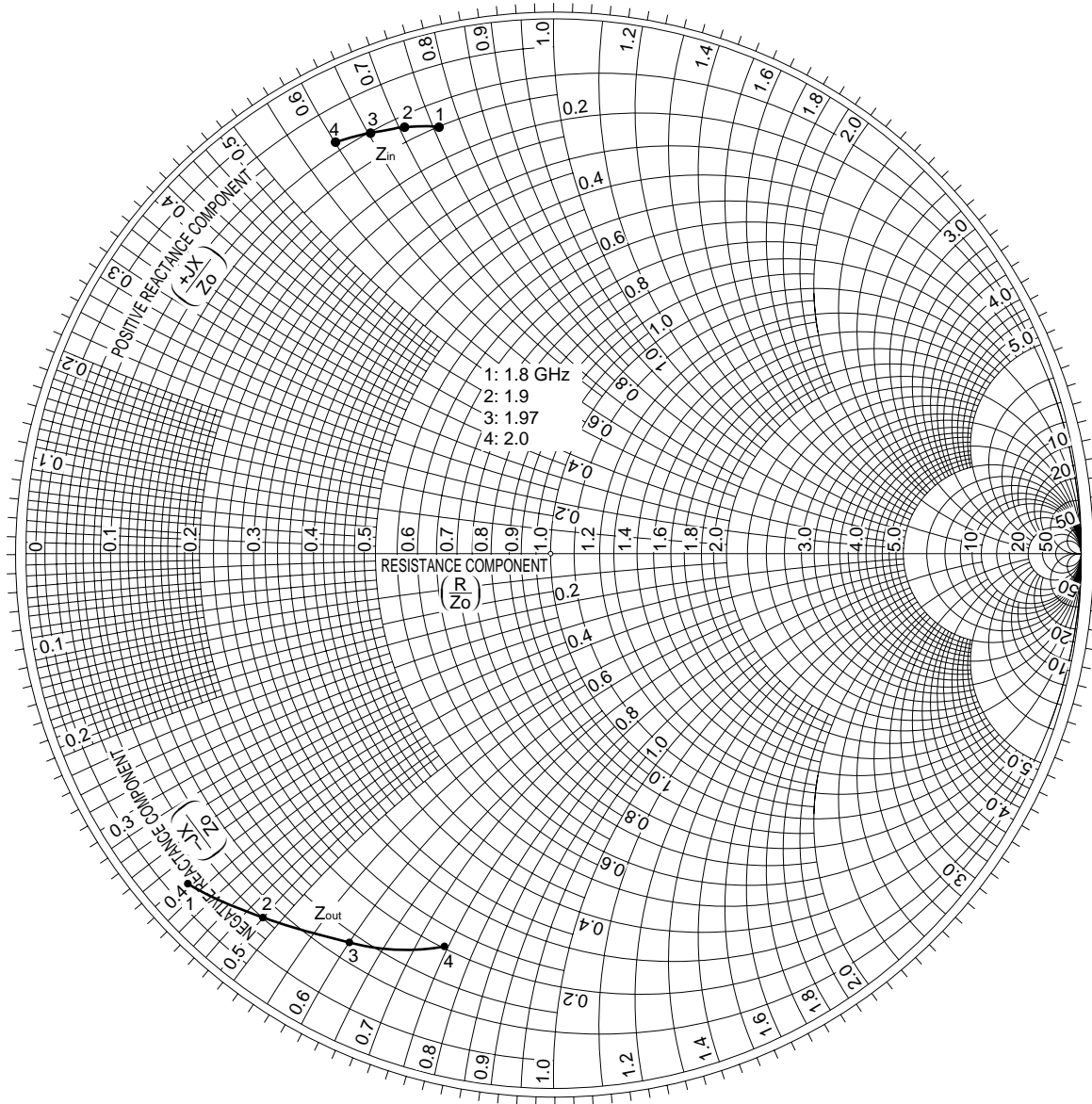

$Z_0 = 50 \text{ ohm}$

f [GHz]	$Z_{in}$ [ohm]	$Z_{out}$ [ohm]
1.80	$8.7 + j38$	$2.2 - j19$
1.90	$6.3 + j36$	$4.1 - j24$
1.97	$5.4 + j33$	$6.4 - j30$
2.00	$4.7 + j30$	$10 - j37$

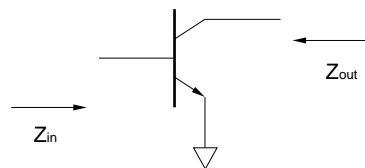

Circuit Drawing

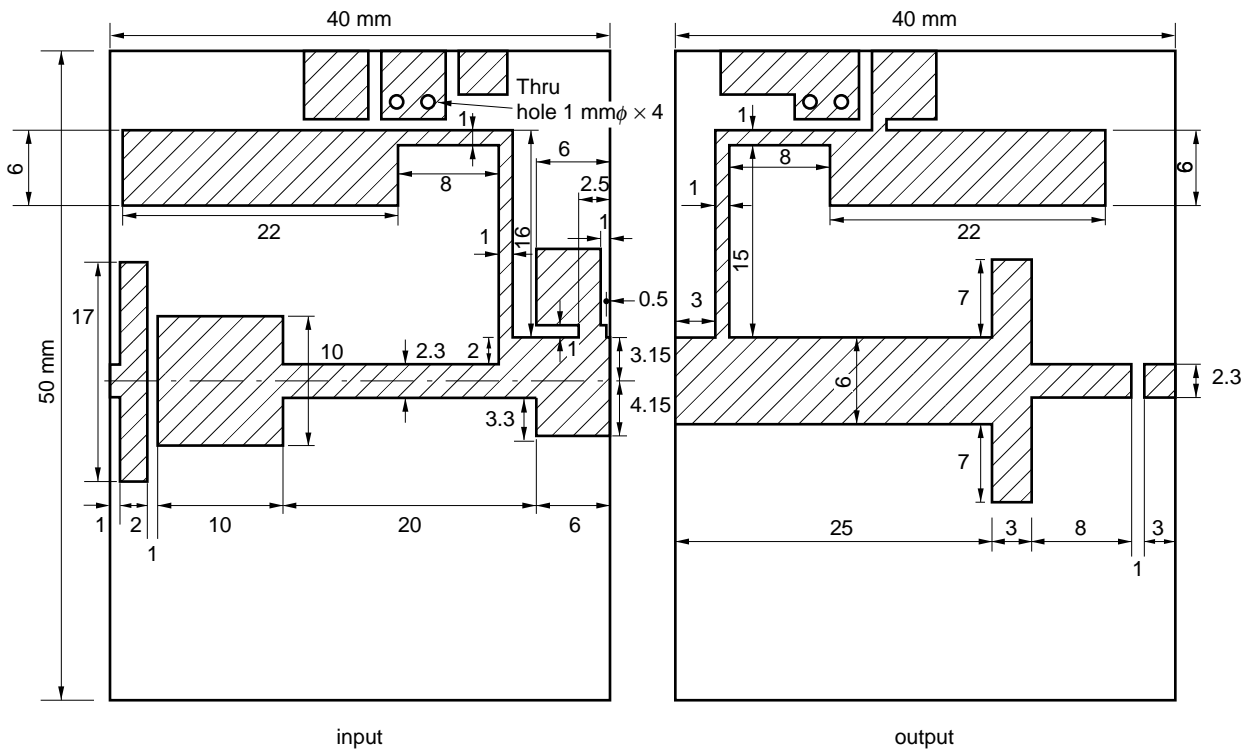

SUBSTRATE (TEFLON)  
 DICLAD 522T®  
 THICKNESS = 0.79 mm  
 DOUBLE SIDE 35  $\mu$ m Cu  
 $\epsilon_r = 2.6$

Components Layout

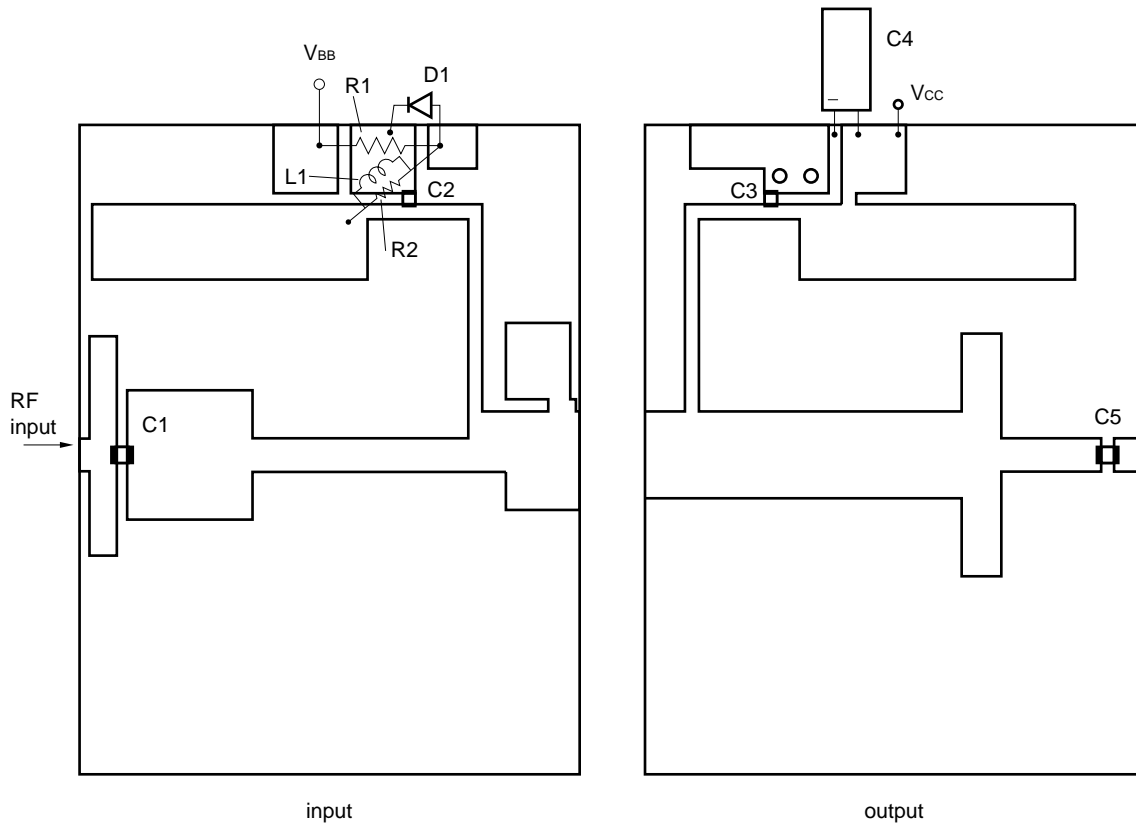

- R1: 5.1  $\Omega$
- R2: 30  $\Omega$
- L1: 5 mm $\phi$  10T Coil
- D1: 1S2075
- C1, C2, C3, C5: MURATA, 47 pF
- C4: 22  $\mu$ F (50 V)  
Electrolytic Capacitor



APPLICATION

= Amplifier Diagrams =

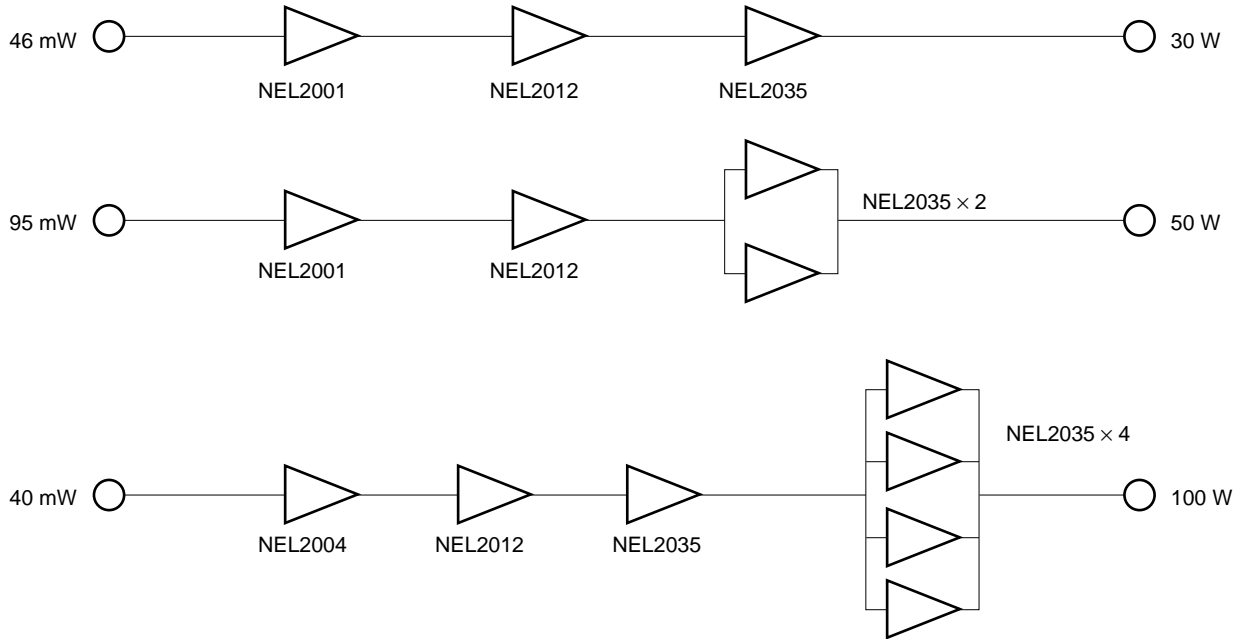

[MEMO]

[MEMO]

No part of this document may be copied or reproduced in any form or by any means without the prior written consent of NEC Corporation. NEC Corporation assumes no responsibility for any errors which may appear in this document.

NEC Corporation does not assume any liability for infringement of patents, copyrights or other intellectual property rights of third parties by or arising from use of a device described herein or any other liability arising from use of such device. No license, either express, implied or otherwise, is granted under any patents, copyrights or other intellectual property rights of NEC Corporation or others.

While NEC Corporation has been making continuous effort to enhance the reliability of its semiconductor devices, the possibility of defects cannot be eliminated entirely. To minimize risks of damage or injury to persons or property arising from a defect in an NEC semiconductor device, customers must incorporate sufficient safety measures in its design, such as redundancy, fire-containment, and anti-failure features.

NEC devices are classified into the following three quality grades:

"Standard", "Special", and "Specific". The Specific quality grade applies only to devices developed based on a customer designated "quality assurance program" for a specific application. The recommended applications of a device depend on its quality grade, as indicated below. Customers must check the quality grade of each device before using it in a particular application.

Standard: Computers, office equipment, communications equipment, test and measurement equipment, audio and visual equipment, home electronic appliances, machine tools, personal electronic equipment and industrial robots

Special: Transportation equipment (automobiles, trains, ships, etc.), traffic control systems, anti-disaster systems, anti-crime systems, safety equipment and medical equipment (not specifically designed for life support)

Specific: Aircrafts, aerospace equipment, submersible repeaters, nuclear reactor control systems, life support systems or medical equipment for life support, etc.

The quality grade of NEC devices is "Standard" unless otherwise specified in NEC's Data Sheets or Data Books. If customers intend to use NEC devices for applications other than those specified for Standard quality grade, they should contact an NEC sales representative in advance.

Anti-radioactive design is not implemented in this product.