

PTF 10134

100 Watts, 2.1–2.2 GHz

GOLDMOS[®] Field Effect Transistor

Description

The PTF 10134 is an internally matched GOLDMOS FET intended for WCDMA applications from 2.1 to 2.2 GHz. It is rated at 100 watts power output and operates with 10 dB typical gain. Nitride surface passivation and gold metallization ensure excellent device lifetime and reliability.

- **INTERNALLY MATCHED**
- **Guaranteed Performance at 2.17 GHz, 28 V**
 - Output Power = 100 Watts Min
 - Power Gain = 10 dB Typ
- **Full Gold Metallization**
- **Excellent Thermal Stability**
- **100% Lot Traceability**

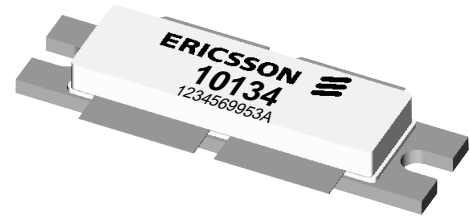
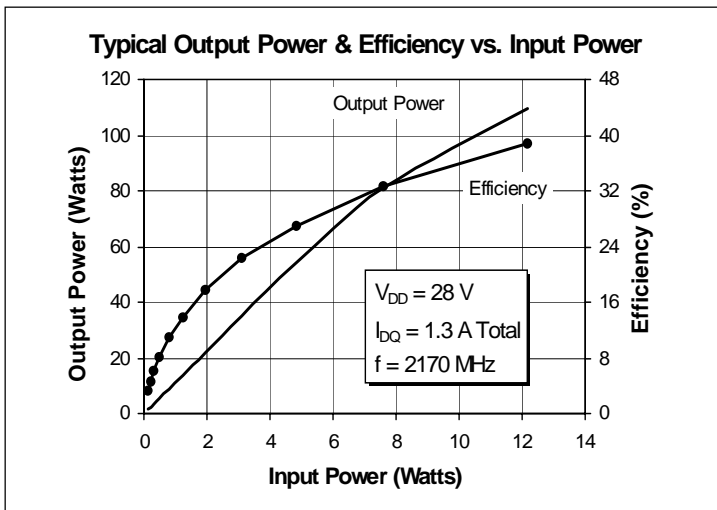

Package 20250

RF Specifications (100% Tested)

Characteristic	Symbol	Min	Typ	Max	Units
Gain ($V_{DD} = 28\text{ V}$, $P_{OUT} = 30\text{ W}$, $I_{DQ} = 1.3\text{ A Total}$, $f = 2.17\text{ GHz}$)	G_{ps}	9.5	10	—	dB
Power Output at 1.5 dB Compression ($V_{DD} = 28\text{ V}$, $I_{DQ} = 1.3\text{ A Total}$, $f = 2.17\text{ GHz}$)	P-1dB	100	—	—	Watts
Drain Efficiency ($V_{DD} = 28\text{ V}$, $P_{OUT} = 100\text{ W}$, $I_{DQ} = 1.3\text{ A Total}$, $f = 2.17\text{ GHz}$)	η_D	—	37	—	%
Load Mismatch Tolerance ($V_{DD} = 28\text{ V}$, $P_{OUT} = 80\text{ W}$, $I_{DQ} = 1.3\text{ A Total}$, $f = 2.17\text{ GHz}$ —all phase angles at frequency of test)	Ψ	—	—	10:1	—

All published data at $T_{CASE} = 25^\circ\text{C}$ unless otherwise indicated.

Electrical Characteristics (100% Tested—characteristics, conditions and limits shown per side)

Characteristic (per side)	Conditions	Symbol	Min	Typ	Max	Units
Drain-Source Breakdown Voltage	$V_{GS} = 0\text{ V}, I_D = 100\text{ mA}$	$V_{(BR)DSS}$	65	—	—	Volts
Zero Gate Voltage Drain Current	$V_{DS} = 28\text{ V}, V_{GS} = 0\text{ V}$	I_{DSS}	—	—	5.0	mA
Gate Threshold Voltage	$V_{DS} = 10\text{ V}, I_D = 150\text{ mA}$	$V_{GS(th)}$	3.0	—	5.0	Volts
Forward Transconductance	$V_{DS} = 10\text{ V}, I_D = 2\text{ A}$	g_{fs}	—	4.0	—	Siemens

Maximum Ratings

Parameter	Symbol	Value	Unit
Drain-Source Voltage ⁽¹⁾	V_{DSS}	65	Vdc
Gate-Source Voltage ⁽¹⁾	V_{GS}	± 20	Vdc
Operating Junction Temperature	T_J	200	$^{\circ}\text{C}$
Total Device Dissipation Above 25 $^{\circ}\text{C}$ derate by	P_D	440 2.51	Watts W/ $^{\circ}\text{C}$
Storage Temperature Range	T_{STG}	-40 to +150	$^{\circ}\text{C}$
Thermal Resistance ($T_{CASE} = 70^{\circ}\text{C}$)	$R_{\theta JC}$	0.39	$^{\circ}\text{C}/\text{W}$

⁽¹⁾ per side

Typical Performance

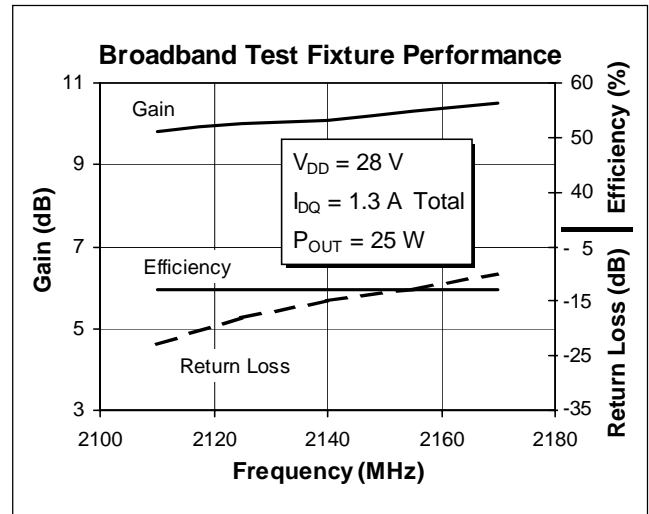
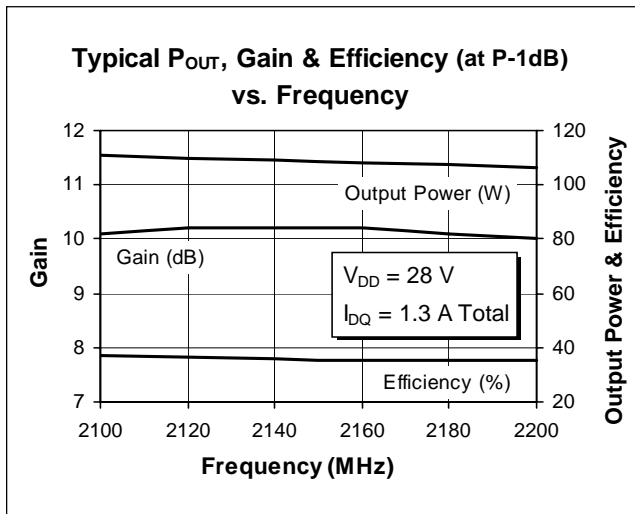

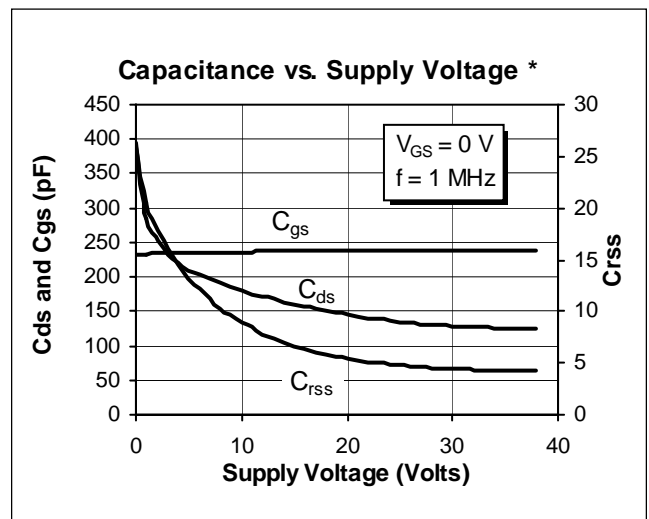
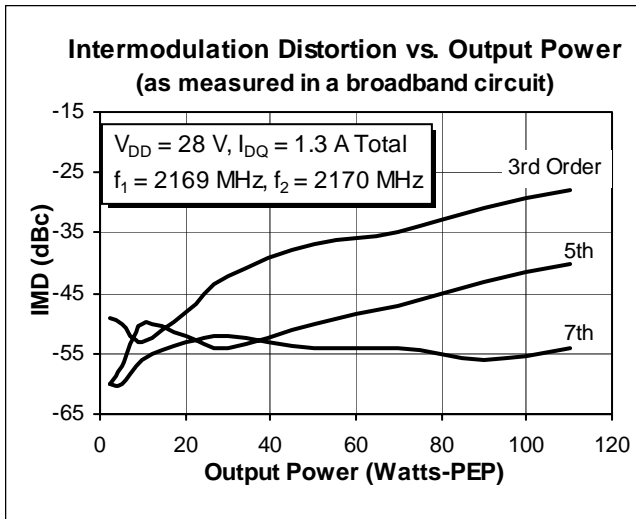
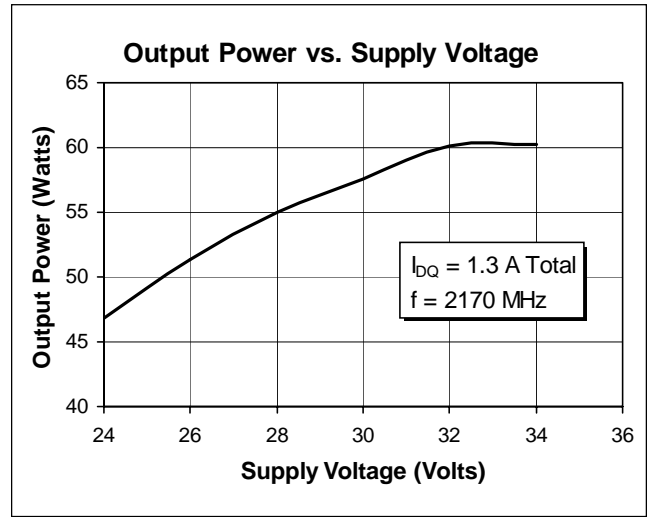
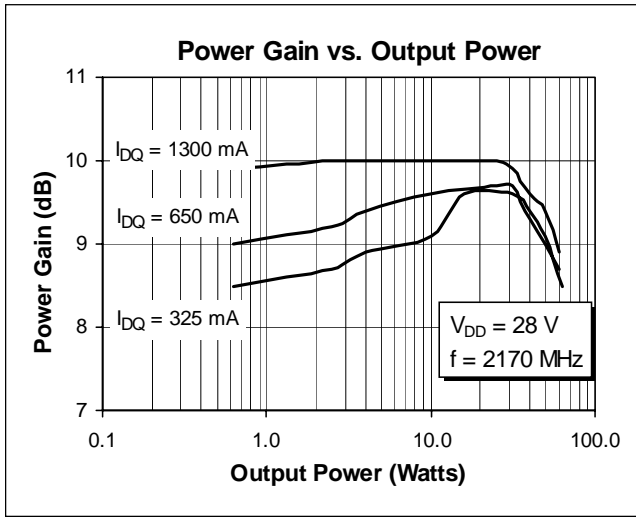

* This part is internally matched. Measurements of the finished product will not yield these results.

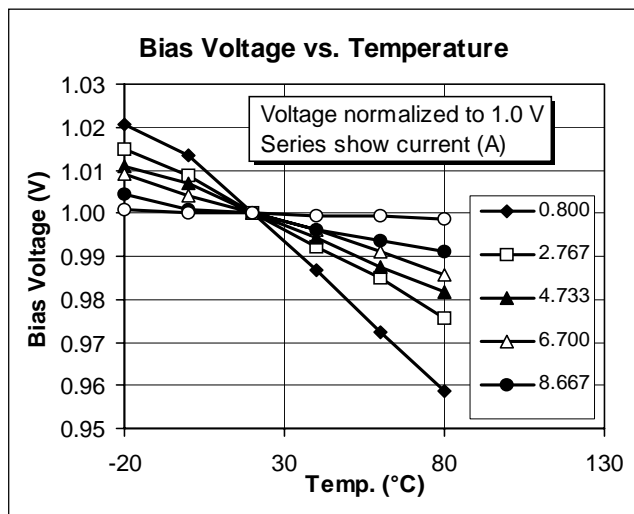

PTF 10134



Impedance Data

($V_{DD} = 28\text{ V}$, $P_{OUT} = 100\text{ W}$,
 $I_{DQ} = 1.3\text{ A Total}$)

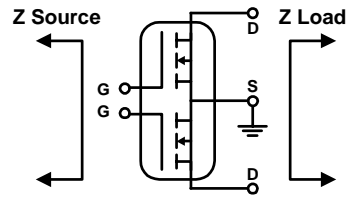

Frequency GHz	Z Source Ω		Z Load Ω	
	R	jX	R	jX
2.00	5.76	-14.40	2.10	-1.80
2.05	7.40	-15.60	2.60	-2.60
2.10	9.60	-17.60	3.00	-3.00
2.15	16.00	-17.80	2.80	-3.80
2.20	19.00	-14.60	2.60	-4.00
2.25	22.00	-6.00	2.44	-3.40
2.30	20.00	-1.20	2.60	-2.80

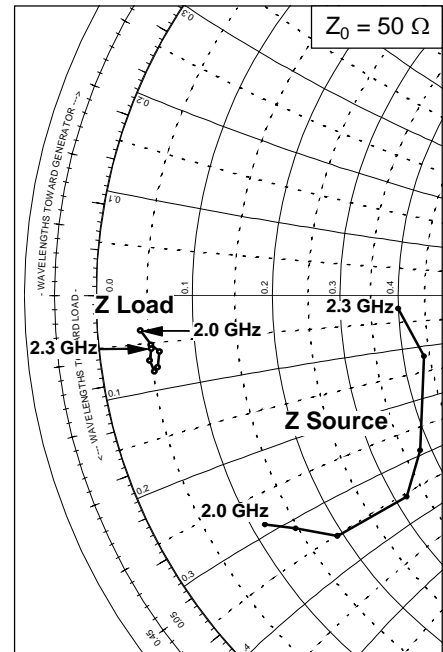

Test Circuit

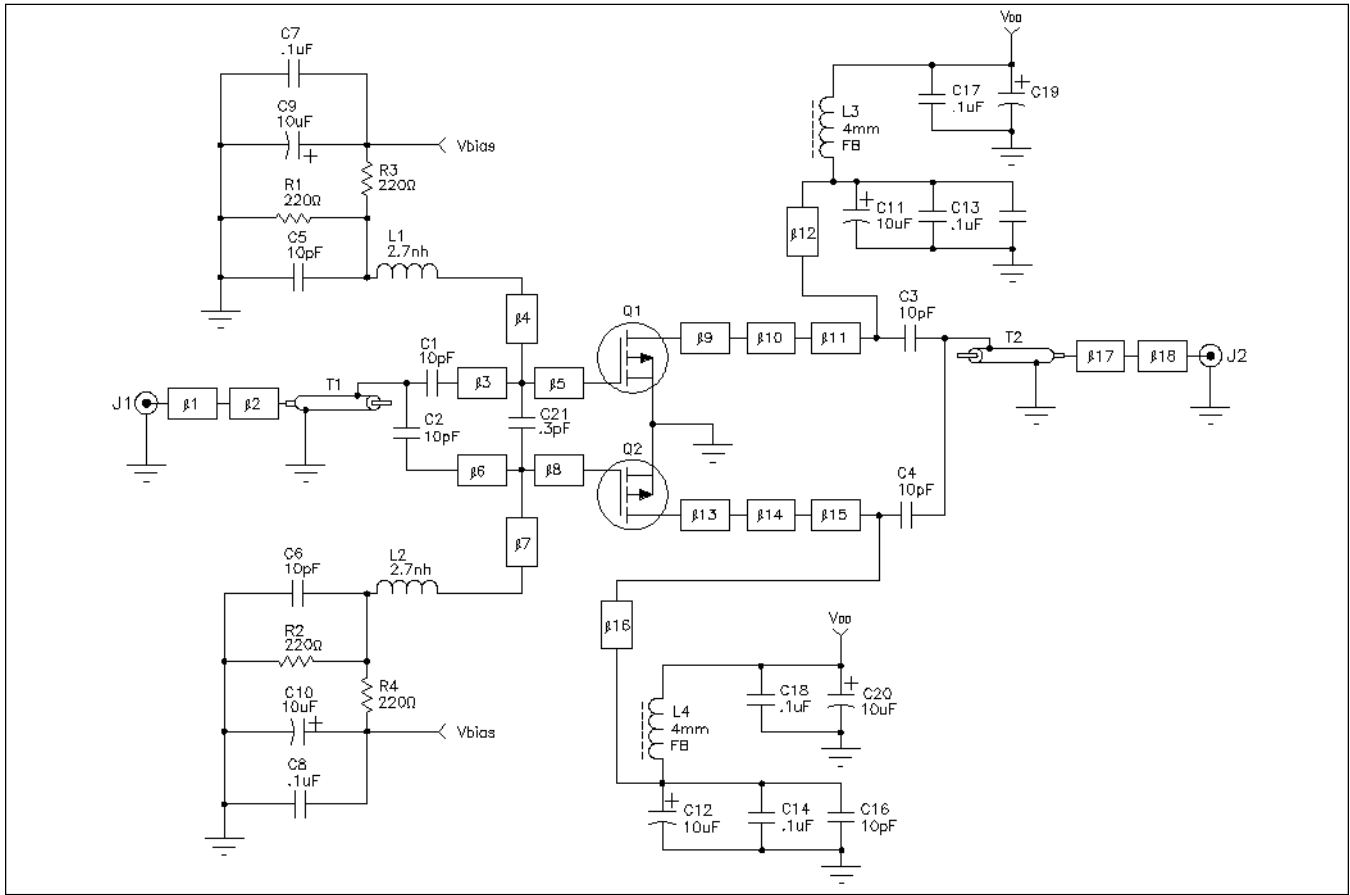

Test Circuit Block Diagram for $f = 2.0$ GHz

l_1	0.184 λ 2.0 GHz Microstrip 50 Ω	
l_2, l_{17}	0.044 λ 2.0 GHz Microstrip 26.1 Ω	
l_3, l_6	0.025 λ 2.0 GHz Microstrip 43.9 Ω	
l_4, l_7	0.185 λ 2.0 GHz Microstrip 67.2 Ω	
l_5, l_8	0.053 λ 2.0 GHz Microstrip 8.7 Ω	
l_9, l_{13}	0.076 λ 2.0 GHz Microstrip 8.7 Ω	
l_{10}, l_{14}	0.031 λ 2.0 GHz Microstrip 9.5 Ω	
l_{11}, l_{15}	0.072 λ 2.0 GHz Microstrip 15.13 Ω	
l_{12}, l_{16}	0.341 λ 2.0 GHz Microstrip 58 Ω	
l_{18}	0.119 λ 2.0 GHz Microstrip 50 Ω	
C1, C2, C3, C4, C5, C6, C15, C16	ATC 100B	Capacitor, 10 pF
C7, C8, C13, C14	Digi-Key P4525-ND	Capacitor, 0.1 μ F
C9, C10, C11, C12, C19, C20	Digi-Key PC56106-ND	Capacitor, 10 μ F 35VDC
C17, C18	ATC 100B	Capacitor, 0.1 μ F
C 21	ATC 100B	Capacitor, 0.3pF
R1, R2, R3, R4	Digi-Key P220ECT-ND	Resistor, 220 Ω
L1, L2	TOKO,# LL2012-F2N7S	Coil, 2.7 nH, SMT
L3, L4	PHILIPS,#BDS31314-6-452	Ferrite Bead, 4mm
T1, T2	Semi-rigid Coaxial Cable, 50 Ω	
Circuit Board	Rogers Microwave	TMM4, ϵ_r 6.0, THICKNESS 0.30", 2 OZ COPPER

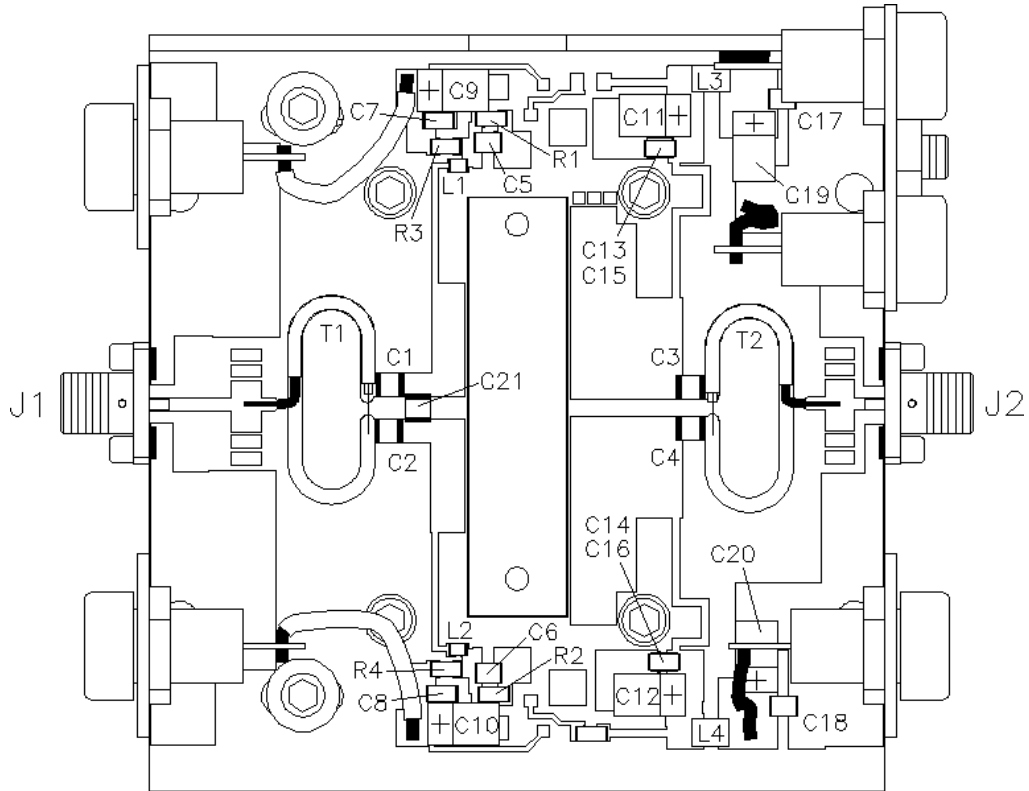

Assembly Diagram (not to scale)

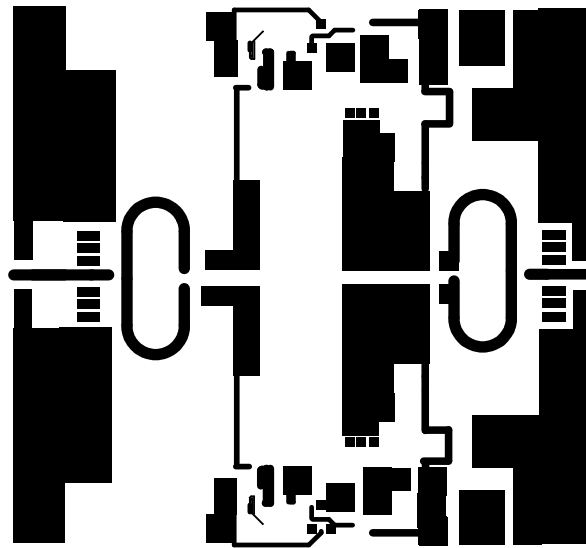

Artwork (scale approximate)

Package Mechanical Description

