

NPN Silicon AF Transistor

BC 846 W ... BC 850 W

Features

- For AF input stages and driver applications
- High current gain
- Low collector-emitter saturation voltage
- Low noise between 30Hz and 15 kHz
- Complementary types: BC 856 W, BC 857 W, BC 858 W, BC 859 W, BC 860 W (PNP)

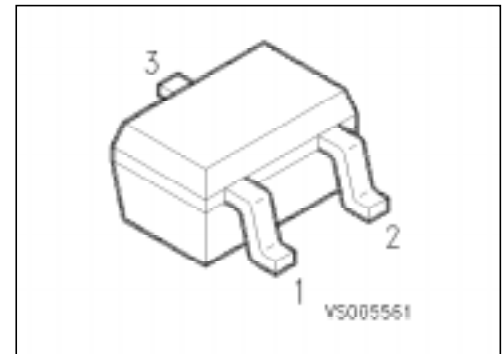

Type	Marking	Ordering code (tape and reel)	Pin Configuration			Package
			1	2	3	
BC 846 AW	1 As	Q62702-C2319	B	E	C	SOT 323
BC 846 BW	1 Bs	Q62702-C2279				SOT 323
BC 847 AW	1 Es	Q62702-C2304				SOT 323
BC 847 BW	1 Fs	Q62702-C2305				SOT 323
BC 847 CW	1 Gs	Q62702-C2306				SOT 323
BC 848 AW	1 Js	Q62702-C2307				SOT 323
BC 848 BW	1 Ks	Q62702-C2308				SOT 323
BC 848 CW	1 Ls	Q62702-C2309				SOT 323
BC 849 BW	2 Bs	Q62702-C2310				SOT 323
BC 849 CW	2 Cs	Q62702-C2311				SOT 323
BC 850 BW	2 Fs	Q62702-C2312				SOT 323
BC 850 CW	2 Gs	Q62702-C2313				SOT 323

Maximum Ratings

Description	Symbol	BC846W BC 847 W BC 849 W BC 848 W BC 840 W			Unit
Collector-emitter voltage	V_{CEO}	65	45	30	V
Collector-base voltage	V_{CBO}	80	50	30	V
Collector-emitter voltage	V_{CES}	80	50	30	V
Emitter-base voltage	V_{EBO}	6	6	5	V
Collector current	I_C		100		mA
Collector peak current	I_{CM}		200		mA
Total power dissipation, $T_s = 115\text{ °C}$	P_{tot}		250		mW
Junction temperature	T_j		150		°C
Storage temperature range	T_{stg}		-65 to 150		°C

Thermal Resistance

Junction - ambient ¹⁾	$R_{th JA}$	≤ 240	K/W
Junction - soldering point	$R_{th JS}$	≤ 105	K/W

¹⁾Package mounted on epoxy pcb 40 mm × 40 mm × 1.5 mm/1 cm² Cu.

Characteristic at $T_A = 25\text{ }^\circ\text{C}$, unless otherwise specified.

Description	Symbol	Ratings			Unit
		min.	typ.	max.	
DC Characteristics					
Collector-emitter breakdown voltage $I_C = 10\text{ mA}$ BC 846 W BC 847 W, BC 850 W BC 848 W, BC 849 W	$V_{(BR)CEO}$	65 45 30	– – –	– – –	V
Collector-base breakdown voltage ¹⁾ $I_C = 100\text{ }\mu\text{A}$ BC 846 W BC 847 W, BC 850 W BC 848 W, BC 849 W	$V_{(BR)CBO}$	80 50 30	– – –	– – –	V
Collector-emitter breakdown voltage $I_C = 10\text{ }\mu\text{A}$, $V_{BE} = 0$ BC 846 W BC 847 W, BC 850 W BC 848 W, BC 849 W	$V_{(BR)CBO}$	80 50 30	– – –	– – –	V
Emitter-base breakdown voltage $I_E = 10\text{ }\mu\text{A}$ BC 846 W, BC 847 W BC 848 W, BC 849 W BC 850	$V_{(BR)EBO}$	6 5	– –	– –	V
Collector-base cutoff current $V_{CB} = 30\text{ V}$ $V_{CB} = 30\text{ V}$, $T_A = 150\text{ }^\circ\text{C}$	I_{CBO}	– –	– –	15 5	nA μA
DC current gain $I_C = 10\text{ }\mu\text{A}$, $V_{CE} = 5\text{ V}$ BC 846 AW ... BC 848 AW BC 846 BW ... BC 850 BW BC 847 CW ... BC 850 CW $I_C = 2\text{ mA}$, $V_{CE} = 5\text{ V}$ BC 846 AW ... BC 848 AW BC 846 BW ... BC 850 BW BC 847 CW ... BC 850 CW	h_{FE}	– – – 110 200 420	140 250 480 180 290 520	– – – 220 450 800	–
Collector-emitter saturation voltage ¹⁾ $I_C = 10\text{ mA}$, $I_B = 0.5\text{ mA}$ $I_C = 100\text{ mA}$, $I_B = 5\text{ mA}$	V_{CEsat}	– –	90 900	250 650	mV
Base-emitter saturation voltage ¹⁾ $I_C = 10\text{ mA}$, $I_B = 0.5\text{ mA}$ $I_C = 100\text{ mA}$, $I_B = 5\text{ mA}$	V_{CEsat}	– –	700 900	– –	mV
Base-emitter voltage ¹⁾ $I_C = 2\text{ mA}$, $V_{CE} = 0.5\text{ mA}$ $I_C = 10\text{ mA}$, $V_{CE} = 5\text{ mA}$	V_{CEsat}	580 –	660 –	700 770	mV

¹⁾Pulse test : $t \leq 300\text{ }\mu\text{s}$, $D = 2\text{ }\%$.

Characteristics at $T_A = 25\text{ °C}$, unless otherwise specified.

Description	Symbol	Ratings			Unit
		min.	typ.	max.	
AC Characteristics					
Transition frequency $I_C = 20\text{ mA}$, $V_{CE} = 5\text{ V}$, $f = 100\text{ MHz}$	f_T	–	250	–	MHz
Output capacitance $V_{CB} = 10\text{ V}$, $f = 1\text{ MHz}$	C_{obo}	–	2	–	pF
Input capacitance $V_{EB} = 0.5\text{ V}$, $f = 1\text{ MHz}$	C_{ibo}	–	10	–	pF
Short-circuit input impedance $I_C = 2\text{ mA}$, $V_{CE} = 5\text{ V}$, $f = 1\text{ kHz}$ BC 846 AW ... BC 849 AW BC 846 BW ... BC 850 BW BC 847 CW ... BC 850 CW	h_{11e}	–	2.7 4.5 8.7	–	k Ω
Open-circuit reverse voltage transfer ratio $I_C = 2\text{ mA}$, $V_{CE} = 5\text{ V}$, $f = 1\text{ kHz}$ BC 846 AW ... BC 849 AW BC 846 BW ... BC 850 BW BC 847 CW ... BC 850 CW	h_{12e}	–	1.5 2.0 3.0	–	10^{-4}
Short-circuit forward current transfer ratio $I_C = 2\text{ mA}$, $V_{CE} = 5\text{ V}$, $f = 1\text{ kHz}$ BC 846 AW ... BC 849 AW BC 846 BW ... BC 850 BW BC 847 CW ... BC 850 CW	h_{21e}	–	200 330 600	–	–
Open-circuit output admittance $I_C = 2\text{ mA}$, $V_{CE} = 5\text{ V}$, $f = 1\text{ kHz}$ BC 846 AW ... BC 849 AW BC 846 BW ... BC 850 BW BC 847 CW ... BC 850 CW	h_{22e}	–	18 30 60	–	μS
Noise figure $I_C = 0.2\text{ mA}$, $V_{CE} = 5\text{ V}$, $R_S = 2\text{ k}\Omega$ $f = 30\text{ Hz} \dots 15\text{ kHz}$ $f = 1\text{ kHz}$, $\Delta f = 200\text{ Hz}$ BC 849 W BC 850 W BC 849 W BC 850 W	F	–	1.4 1.4 1.2 1.0	4 3 4 4	dB
Equivalent noise voltage $I_C = 0.2\text{ mA}$, $V_{CE} = 5\text{ V}$, $R_S = 2\text{ k}\Omega$ $f = 10\text{ Hz} \dots 50\text{ Hz}$ BC 850 W	V_n	–	–	0.135	μV

Curves see BC 846 ... BC 840

Total power dissipation $P_{tot} = f(T_A^*; T_S)$

* Package mounted on epoxy

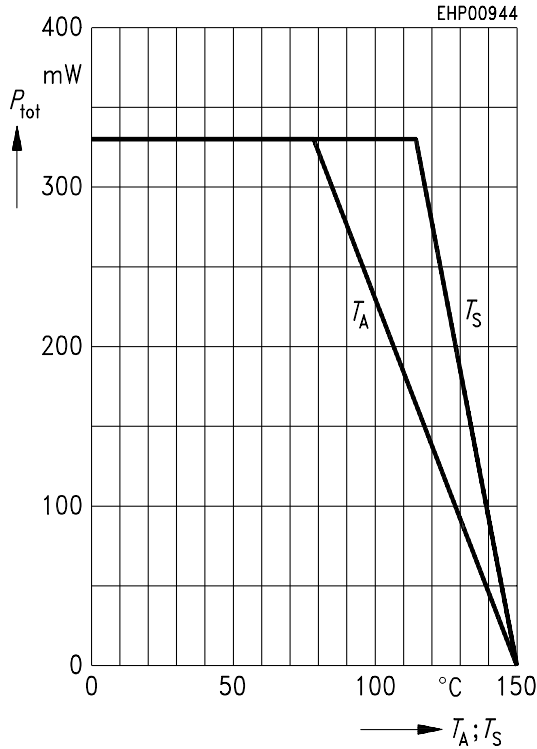

Collector-base capacitance $C_{CB0} = f(V_{CB0})$

Emitter-base capacitance $C_{EB0} = f(V_{EB0})$

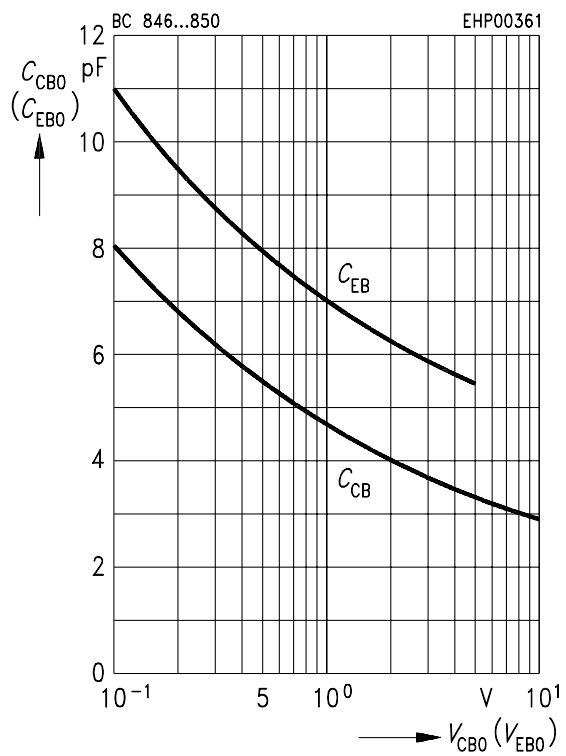

Permissible pulse load $P_{tot max}/P_{tot DC} = f(t_p)$

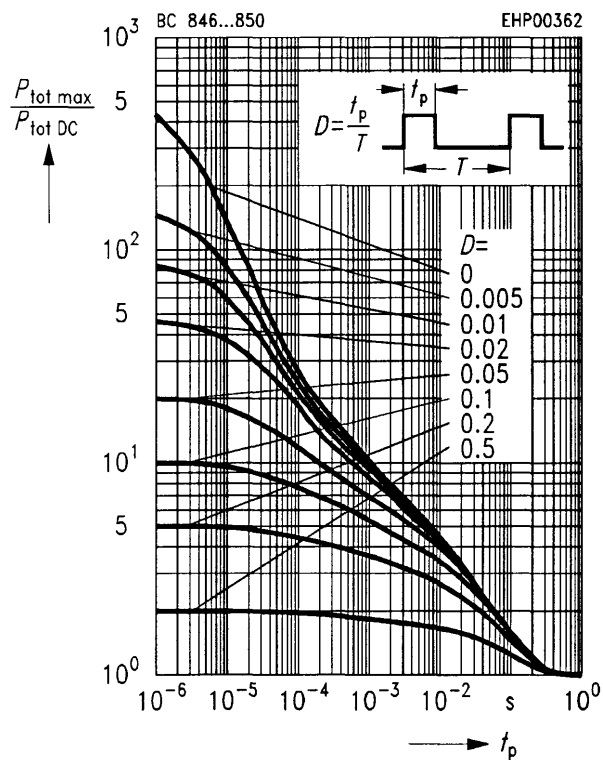

Transition frequency $f_T = f(I_C)$

$V_{CE} = 5 V$

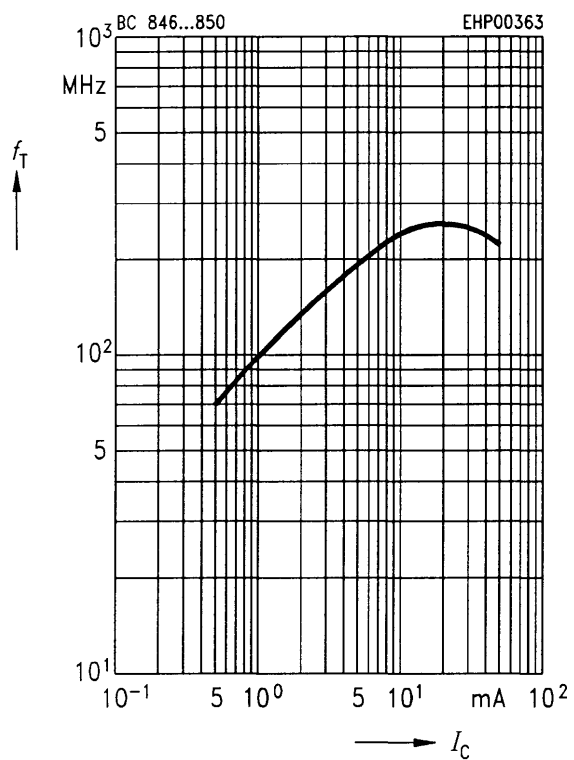

Collector cutoff current $I_{CB0} = f(T_A)$

$V_{CB} = 30\text{ V}$

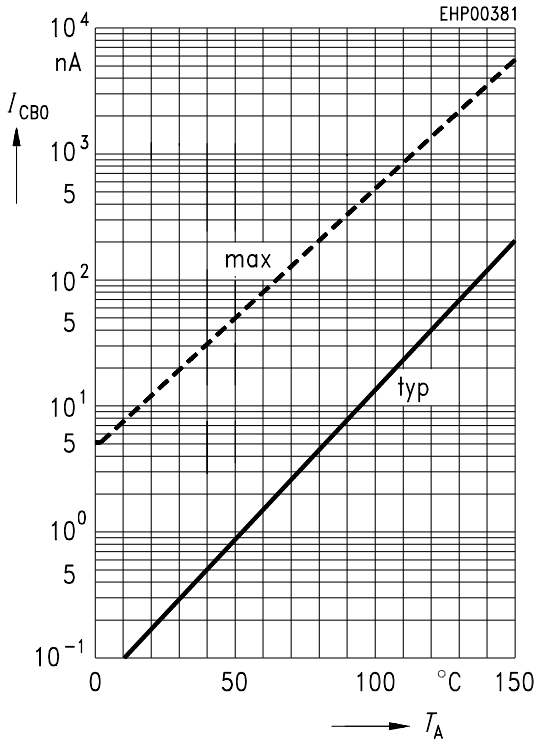

Collector-emitter saturation voltage

$I_C = f(V_{CEsat}), h_{FE} = 20$

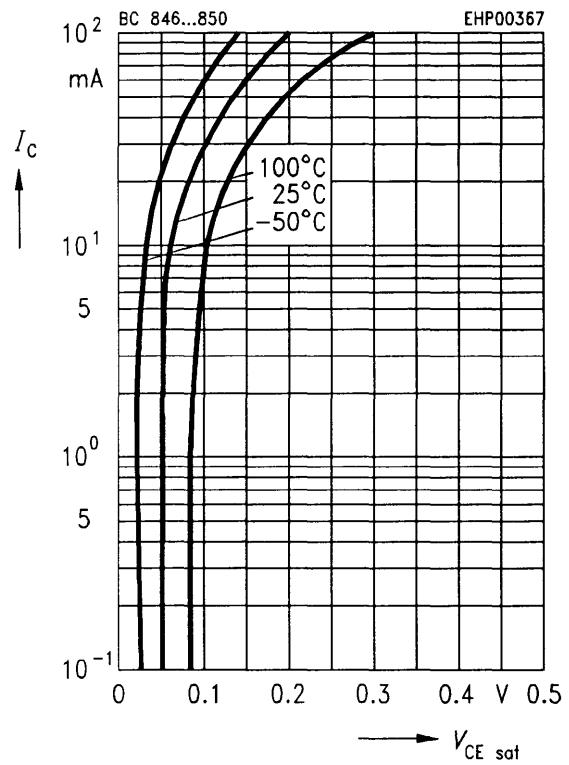

DC current gain $h_{FE} = f(I_C)$

$V_{CE} = 5\text{ V}$

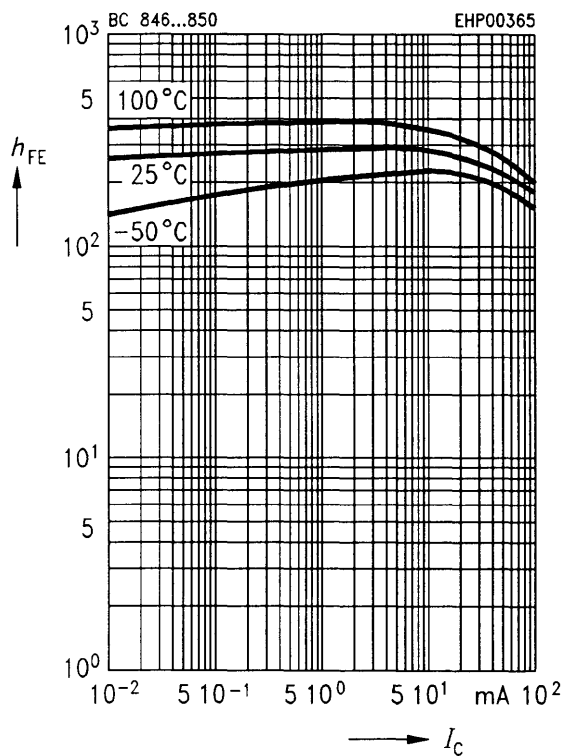

Base-emitter saturation voltage

$I_C = f(V_{BEsat}), h_{FE} = 20$

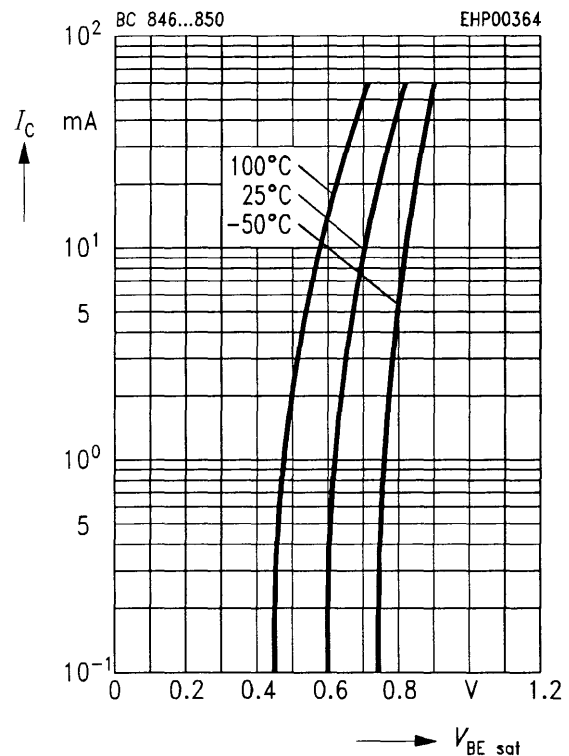

h parameter $h_e = f(I_C)$ normalized

$V_{CE} = 5\text{ V}$

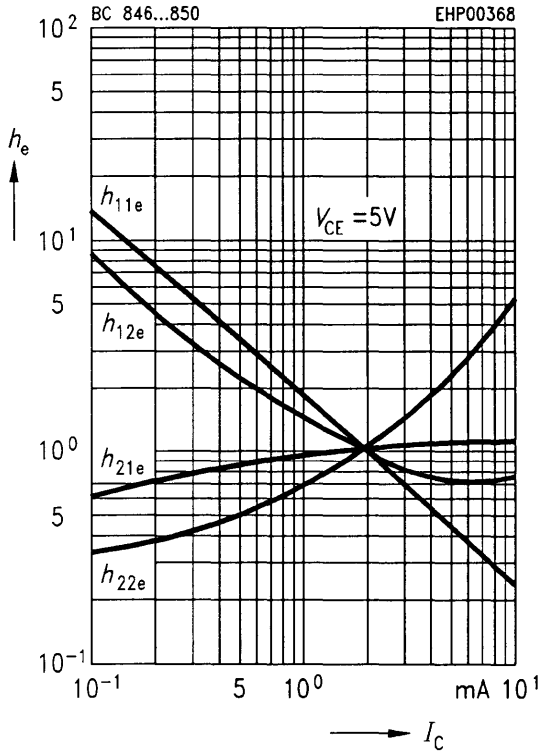

h parameter $h_e = f(V_{CE})$ normalized

$I_C = 2\text{ mA}$

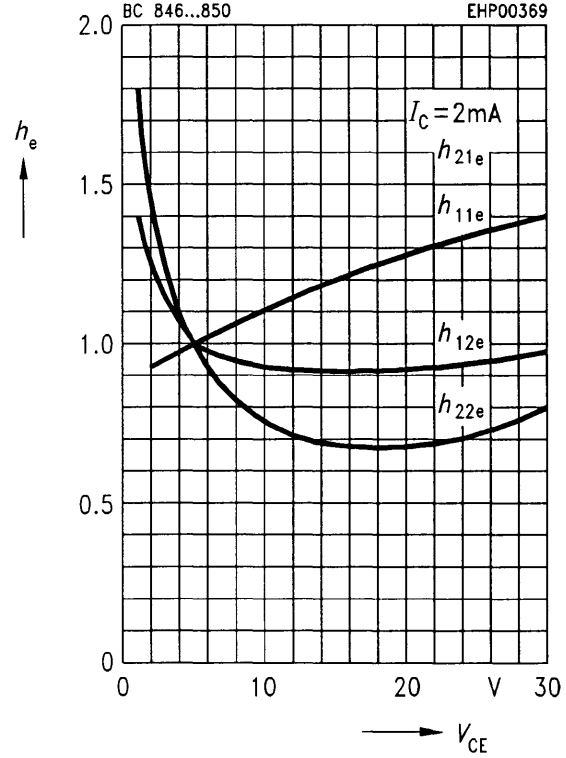

Noise figure $F = f(V_{CE})$

$I_C = 0.2\text{ mA}, R_S = 2\text{ k}\Omega, f = 1\text{ kHz}$

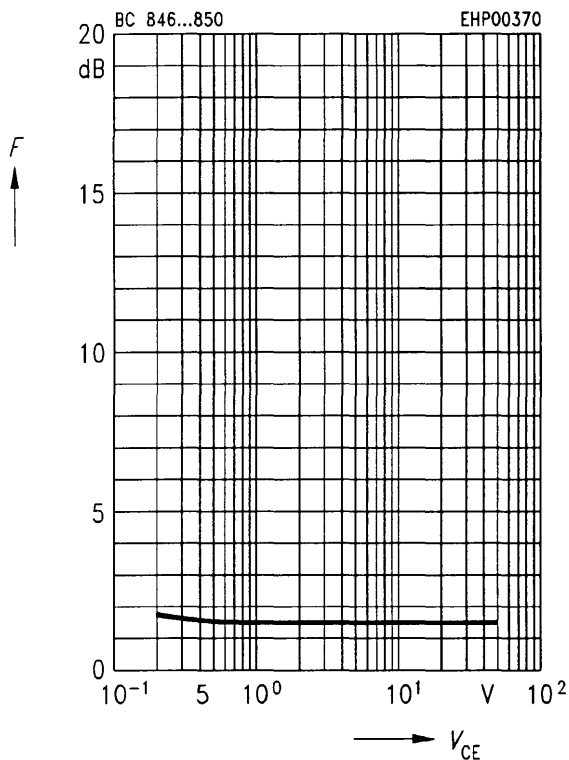

Noise figure $F = f(f)$

$I_C = 0.2\text{ mA}, V_{CE} = 5\text{ V}, R_S = 2\text{ k}\Omega$

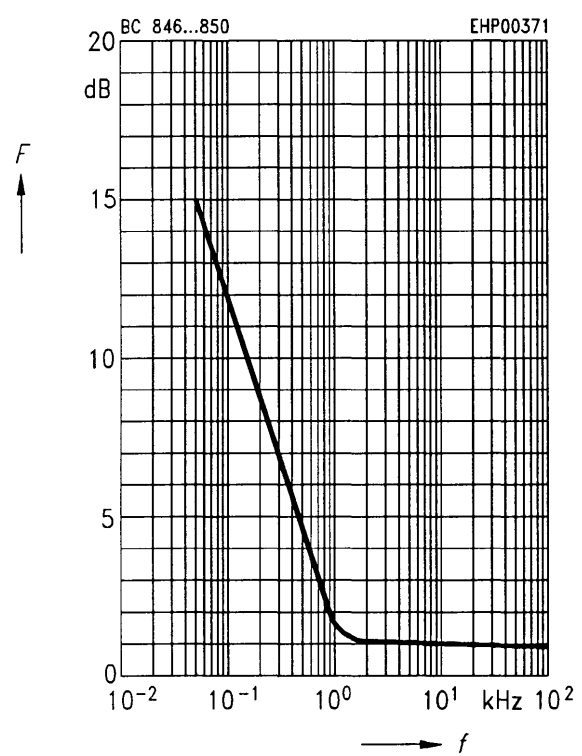

Noise figure $F = f(I_C)$

$V_{CE} = 5 \text{ V}, f = 120 \text{ Hz}$

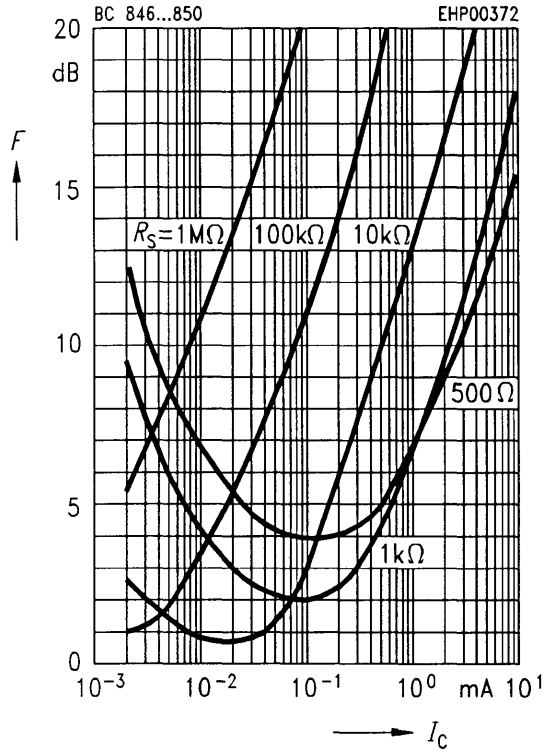

Noise figure $F = f(I_C)$

$V_{CE} = 5 \text{ V}, f = 1 \text{ kHz}$

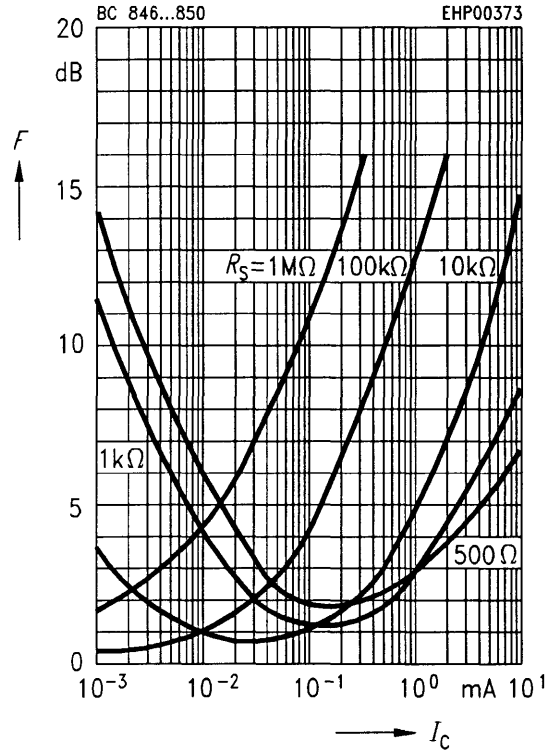

Noise figure $F = f(I_C)$

$V_{CE} = 5 \text{ V}, f = 10 \text{ kHz}$

