

# DATA SHEET

## **BF1100WR** Dual-gate MOS-FET

Product specification  
File under Discrete Semiconductors, SC07

1995 Apr 25

**Philips Semiconductors**



**PHILIPS**

# Dual-gate MOS-FET

# BF1100WR

### FEATURES

- Specially designed for use at 9 to 12 V supply voltage
- Short channel transistor with high forward transfer admittance to input capacitance ratio
- Low noise gain controlled amplifier up to 1 GHz
- Superior cross-modulation performance during AGC.

### APPLICATIONS

- VHF and UHF applications such as television tuners and professional communications equipment.

### DESCRIPTION

Enhancement type field-effect transistor in a plastic microminiature SOT343R package. The transistor consists of an amplifier MOS-FET with source and substrate interconnected and an internal bias circuit to ensure good cross-modulation performance during AGC.

**CAUTION**

The device is supplied in an antistatic package. The gate-source input must be protected against static discharge during transport or handling.

### PINNING

PIN	SYMBOL	DESCRIPTION
1	s, b	source
2	d	drain
3	g <sub>2</sub>	gate 2
4	g <sub>1</sub>	gate 1

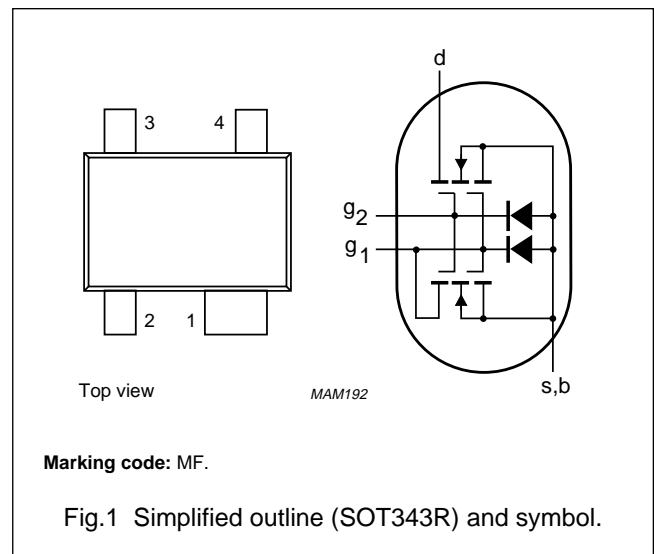

### QUICK REFERENCE DATA

SYMBOL	PARAMETER	CONDITIONS	MIN.	TYP.	MAX.	UNIT
V <sub>DS</sub>	drain-source voltage		–	–	14	V
I <sub>D</sub>	drain current		–	–	30	mA
P <sub>tot</sub>	total power dissipation		–	–	280	mW
T <sub>j</sub>	operating junction temperature		–	–	150	°C
y <sub>fs</sub>	forward transfer admittance		24	28	33	mS
C <sub>ig1-s</sub>	input capacitance at gate 1		–	2.2	2.6	pF
C <sub>rs</sub>	reverse transfer capacitance	f = 1 MHz	–	25	35	fF
F	noise figure	f = 800 MHz	–	2	–	dB

# Dual-gate MOS-FET

# BF1100WR

### LIMITING VALUES

In accordance with the Absolute Maximum Rating System (IEC 134).

SYMBOL	PARAMETER	CONDITIONS	MIN.	MAX.	UNIT
$V_{DS}$	drain-source voltage		–	14	V
$I_D$	drain current		–	30	mA
$I_{G1}$	gate 1 current		–	$\pm 10$	mA
$I_{G2}$	gate 2 current		–	$\pm 10$	mA
$P_{tot}$	total power dissipation	see Fig.2; up to $T_{amb} = 50\text{ }^\circ\text{C}$ ; note 1	–	280	mW
$T_{stg}$	storage temperature		–65	+150	$^\circ\text{C}$
$T_j$	operating junction temperature		–	+150	$^\circ\text{C}$

### Note

1. Device mounted on a printed-circuit board.

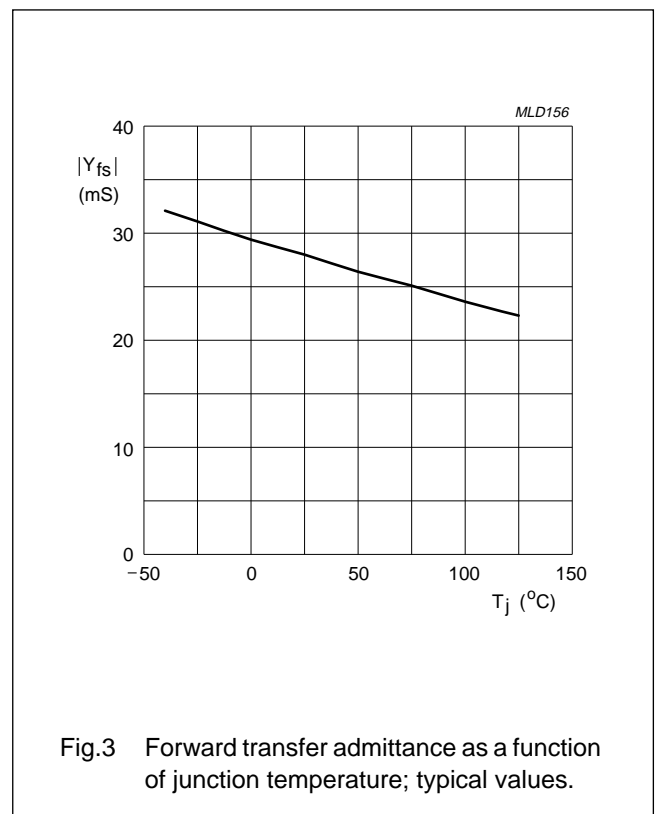
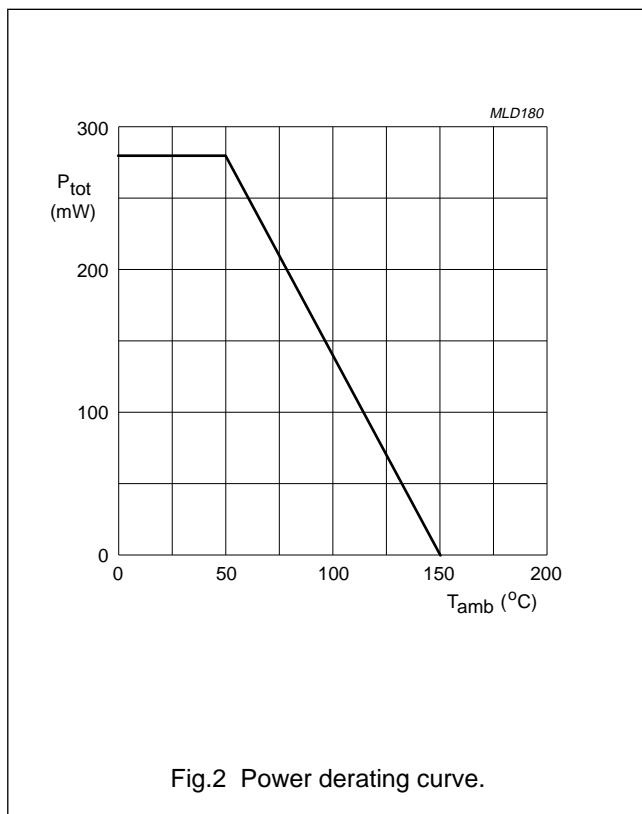

## Dual-gate MOS-FET

BF1100WR

## THERMAL CHARACTERISTICS

SYMBOL	PARAMETER	CONDITIONS	VALUE	UNIT
$R_{th\ j-a}$	thermal resistance from junction to ambient	note 1	350	K/W
$R_{th\ j-s}$	thermal resistance from junction to soldering point	$T_s = 91\text{ °C}$ ; note 2	210	K/W

## Notes

1. Device mounted on a printed-circuit board.
2.  $T_s$  is the temperature at the soldering point of the source lead.

## STATIC CHARACTERISTICS

$T_j = 25\text{ °C}$ ; unless otherwise specified.

SYMBOL	PARAMETER	CONDITIONS	MIN.	MAX.	UNIT
$V_{(BR)G1-SS}$	gate 1-source breakdown voltage	$V_{G2-S} = V_{DS} = 0$ ; $I_{G1-S} = 1\text{ mA}$	13.2	20	V
$V_{(BR)G2-SS}$	gate 2-source breakdown voltage	$V_{G1-S} = V_{DS} = 0$ ; $I_{G2-S} = 1\text{ mA}$	13.2	20	V
$V_{(F)S-G1}$	forward source-gate 1 voltage	$V_{G2-S} = V_{DS} = 0$ ; $I_{S-G1} = 10\text{ mA}$	0.5	1.5	V
$V_{(F)S-G2}$	forward source-gate 2 voltage	$V_{G1-S} = V_{DS} = 0$ ; $I_{S-G2} = 10\text{ mA}$	0.5	1.5	V
$V_{G1-S(th)}$	gate 1-source threshold voltage	$V_{G2-S} = 4\text{ V}$ ; $V_{DS} = 9\text{ V}$ ; $I_D = 20\text{ }\mu\text{A}$	0.3	1	V
		$V_{G2-S} = 4\text{ V}$ ; $V_{DS} = 12\text{ V}$ ; $I_D = 20\text{ }\mu\text{A}$	0.3	1	V
$V_{G2-S(th)}$	gate 2-source threshold voltage	$V_{G1-S} = 4\text{ V}$ ; $V_{DS} = 9\text{ V}$ ; $I_D = 20\text{ }\mu\text{A}$	0.3	1.2	V
		$V_{G1-S} = 4\text{ V}$ ; $V_{DS} = 12\text{ V}$ ; $I_D = 20\text{ }\mu\text{A}$	0.3	1.2	V
$I_{DSX}$	drain-source current	$V_{G2-S} = 4\text{ V}$ ; $V_{DS} = 9\text{ V}$ ; $R_{G1} = 180\text{ k}\Omega$ ; note 1	8	13	mA
		$V_{G2-S} = 4\text{ V}$ ; $V_{DS} = 12\text{ V}$ ; $R_{G1} = 250\text{ k}\Omega$ ; note 2	8	13	mA
$I_{G1-SS}$	gate 1 cut-off current	$V_{G2-S} = V_{DS} = 0$ ; $V_{G1-S} = 12\text{ V}$	–	50	nA
$I_{G2-SS}$	gate 2 cut-off current	$V_{G1-S} = V_{DS} = 0$ ; $V_{G2-S} = 12\text{ V}$	–	50	nA

## Notes

1.  $R_{G1}$  connects gate 1 to  $V_{GG} = 9\text{ V}$ ; see Fig.26.
2.  $R_{G1}$  connects gate 1 to  $V_{GG} = 12\text{ V}$ ; see Fig.26.

Dual-gate MOS-FET

BF1100WR

**DYNAMIC CHARACTERISTICS**

Common source;  $T_{amb} = 25\text{ }^{\circ}\text{C}$ ;  $V_{G2-S} = 4\text{ V}$ ;  $I_D = 10\text{ mA}$ ; unless otherwise specified.

SYMBOL	PARAMETER	CONDITIONS	MIN.	TYP.	MAX.	UNIT
$ y_{fs} $	forward transfer admittance	pulsed; $T_j = 25\text{ }^{\circ}\text{C}$ $V_{DS} = 9\text{ V}$	24	28	33	mS
		$V_{DS} = 12\text{ V}$	24	28	33	mS
$C_{ig1-s}$	input capacitance at gate 1	$f = 1\text{ MHz}$ $V_{DS} = 9\text{ V}$	–	2.2	2.6	pF
		$V_{DS} = 12\text{ V}$	–	2.2	2.6	pF
$C_{ig2-s}$	input capacitance at gate 2	$f = 1\text{ MHz}$ $V_{DS} = 9\text{ V}$	–	1.6	–	pF
		$V_{DS} = 12\text{ V}$	–	1.4	–	pF
$C_{os}$	drain-source capacitance	$f = 1\text{ MHz}$ $V_{DS} = 9\text{ V}$	–	1.4	1.8	pF
		$V_{DS} = 12\text{ V}$	–	1.1	1.5	pF
$C_{rs}$	reverse transfer capacitance	$f = 1\text{ MHz}$ $V_{DS} = 9\text{ V}$	–	25	35	fF
		$V_{DS} = 12\text{ V}$	–	25	35	fF
F	noise figure	$f = 800\text{ MHz}$ ; $G_S = G_{Sopt}$ ; $B_S = B_{Sopt}$ $V_{DS} = 9\text{ V}$	–	2	2.8	dB
		$V_{DS} = 12\text{ V}$	–	2	2.8	dB

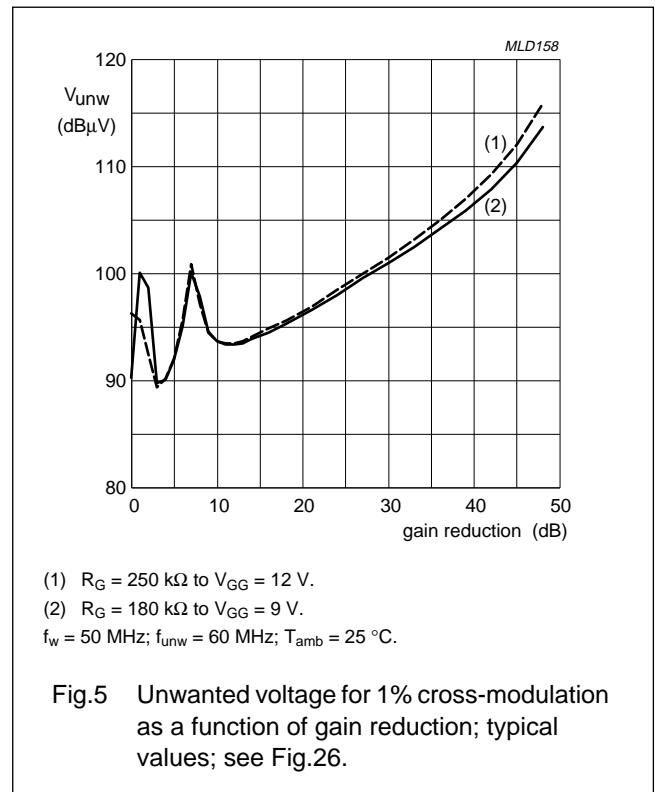
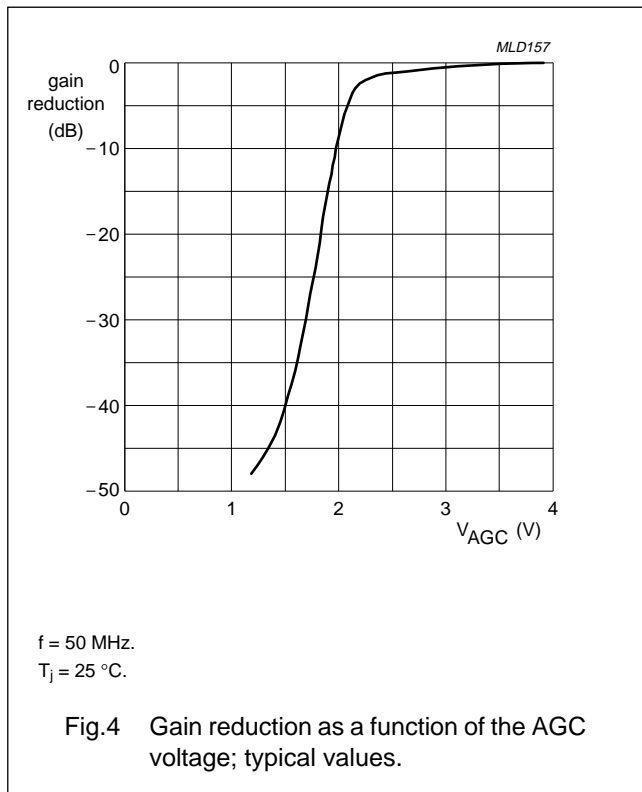

Dual-gate MOS-FET

BF1100WR

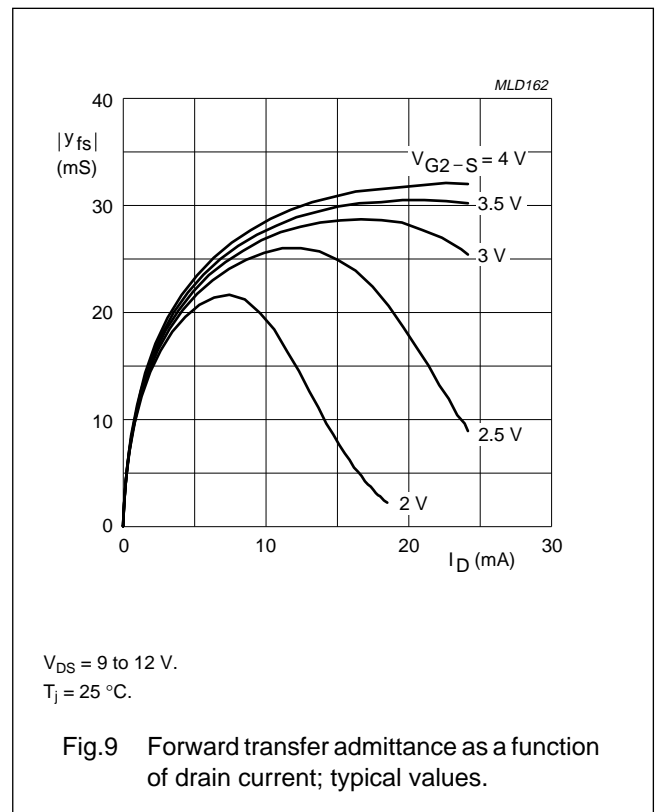
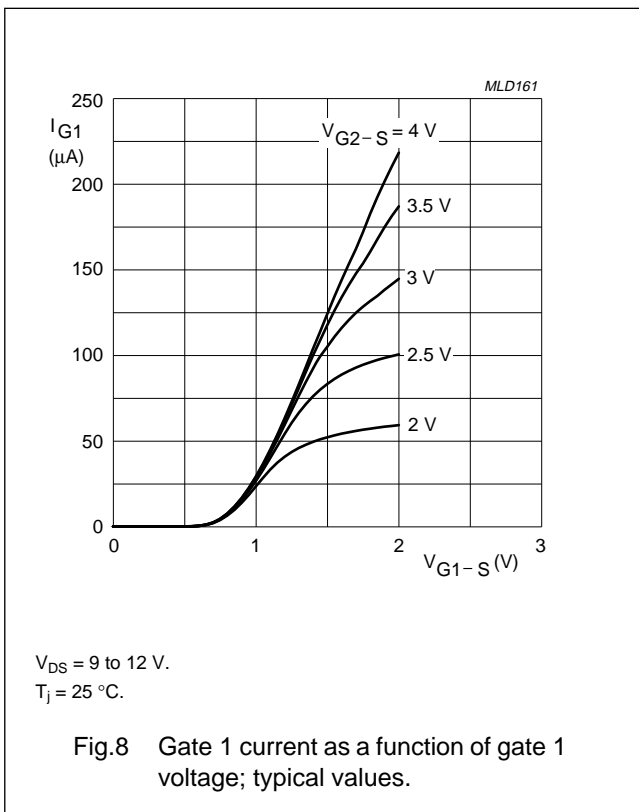
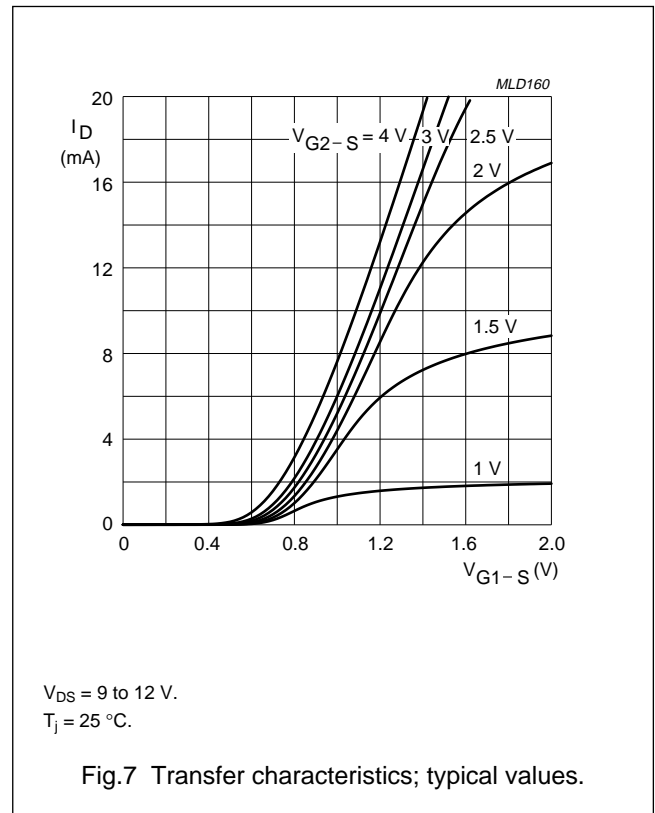
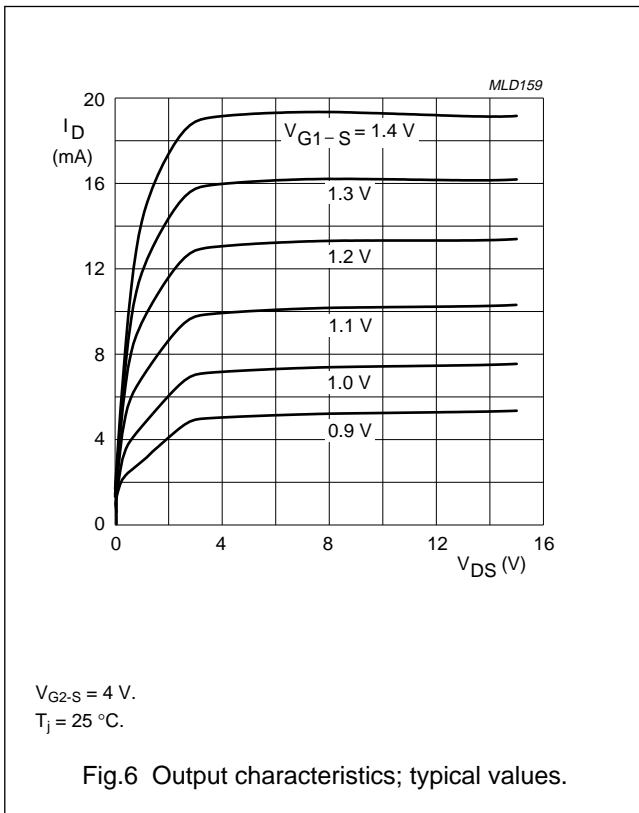

Dual-gate MOS-FET

BF1100WR

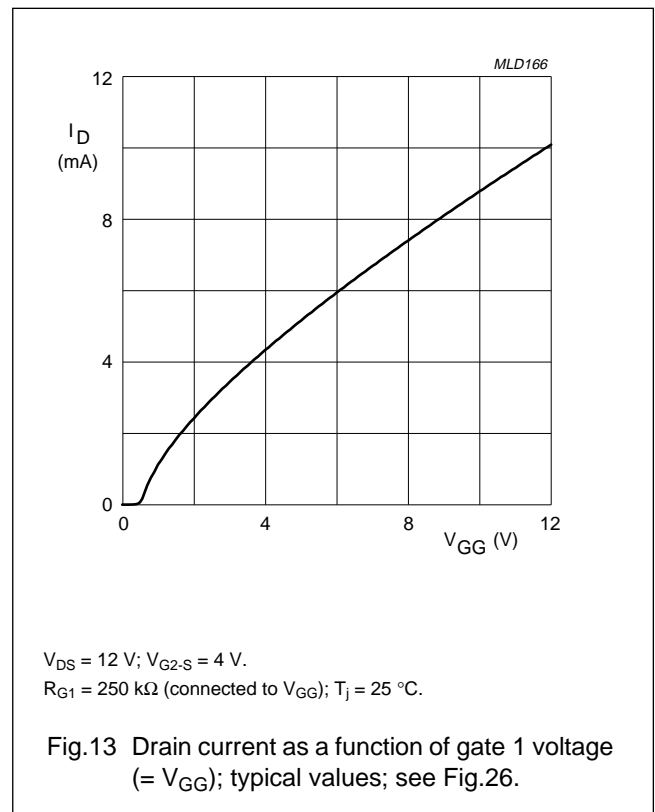
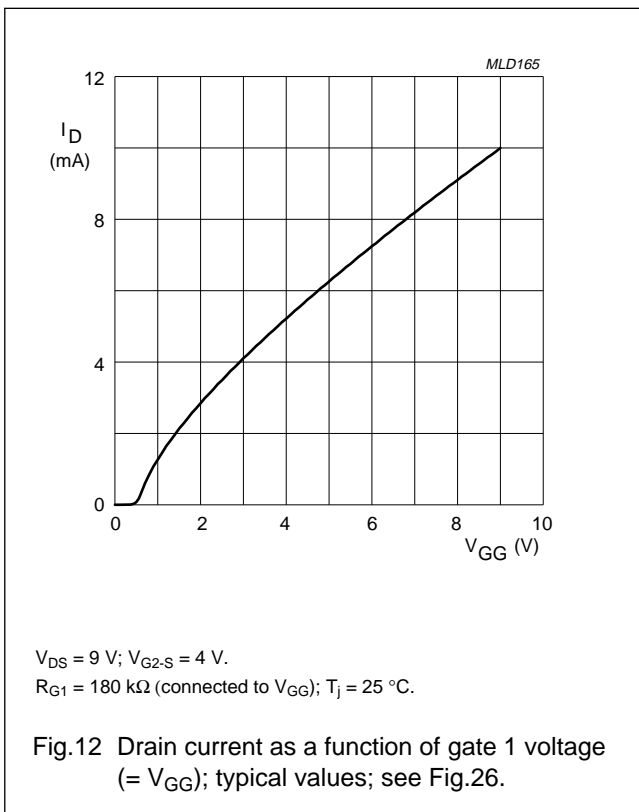
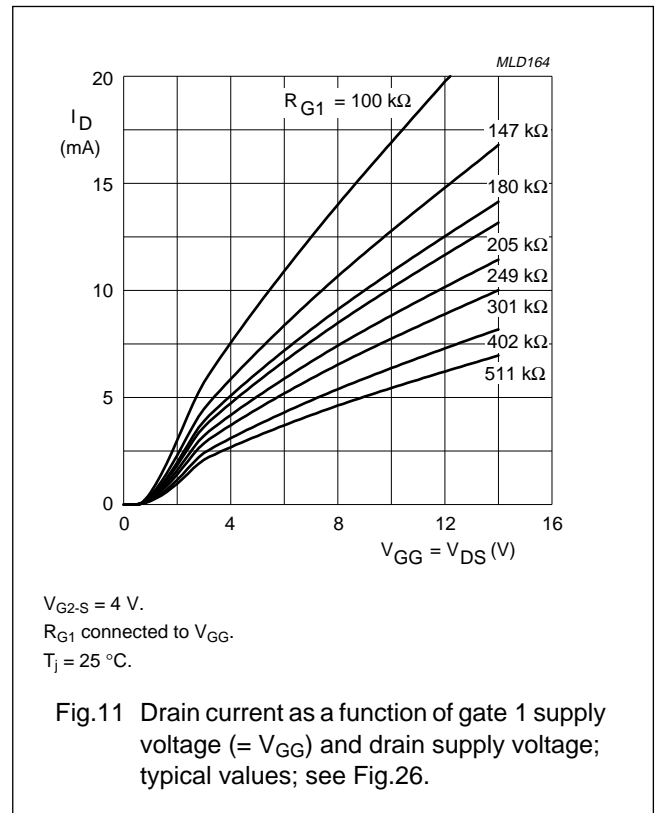
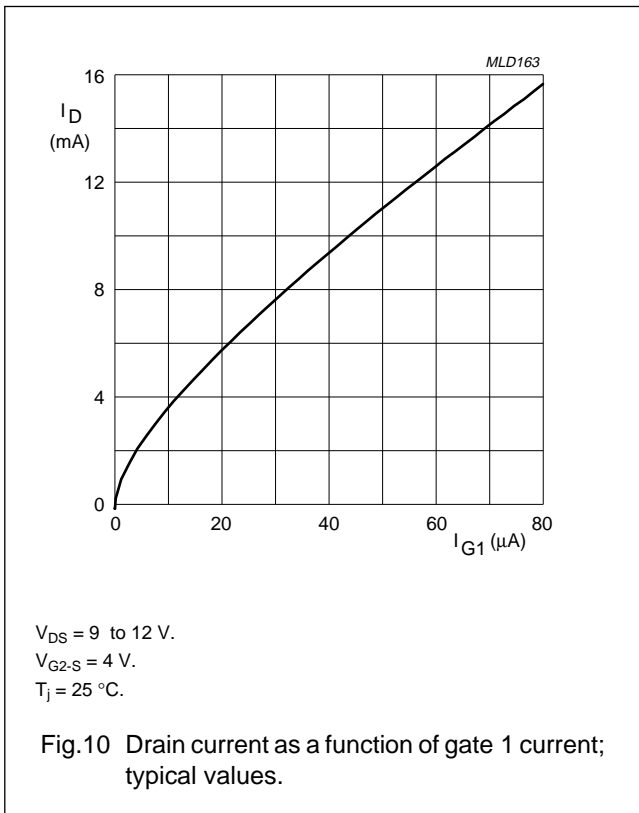

Dual-gate MOS-FET

BF1100WR

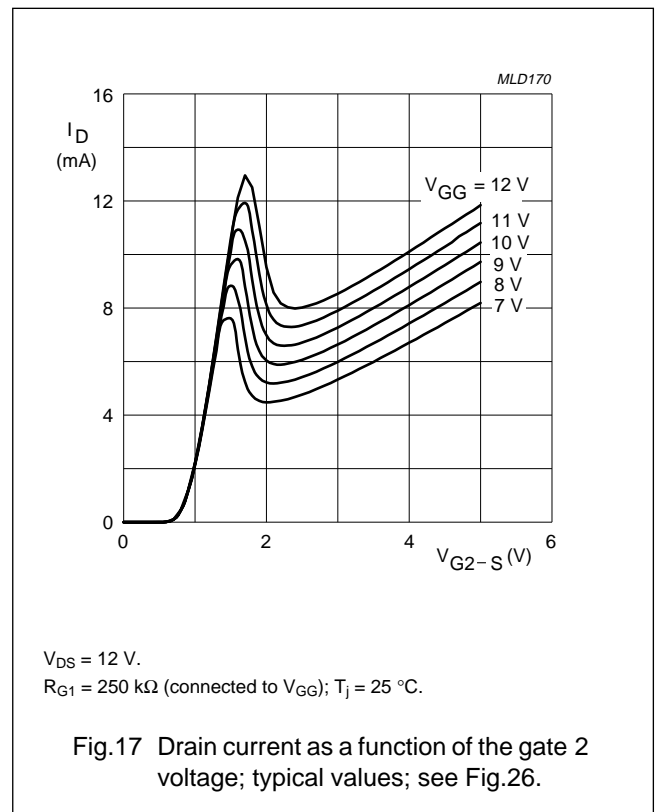
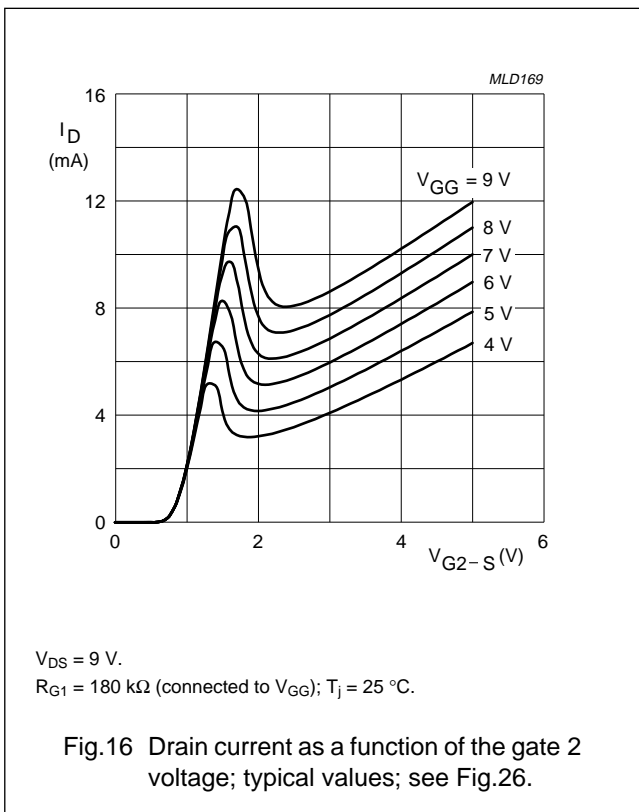
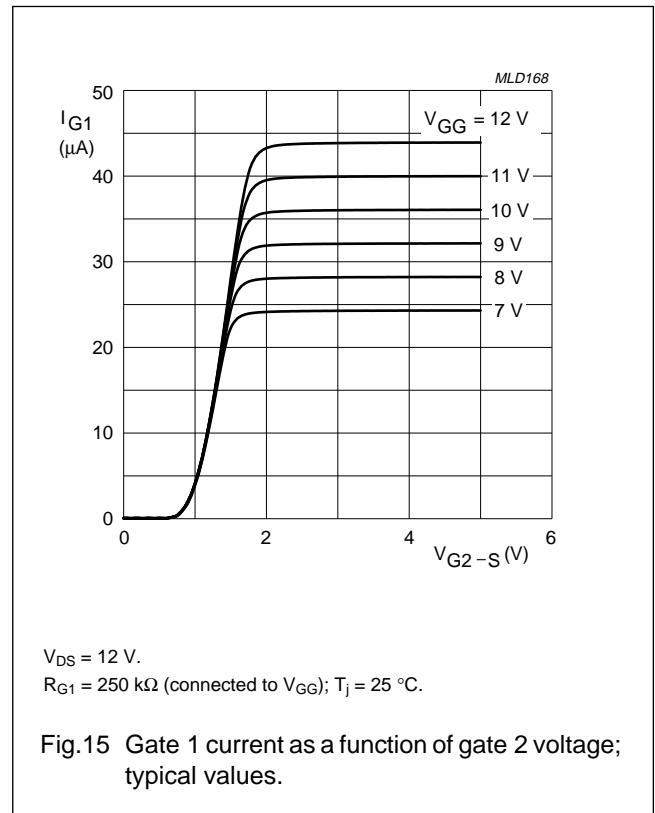
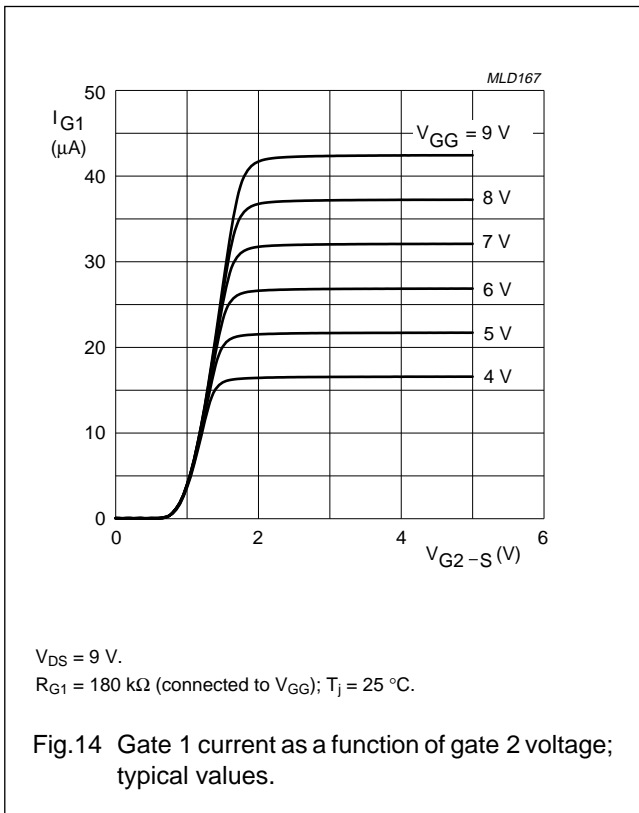



Dual-gate MOS-FET

BF1100WR

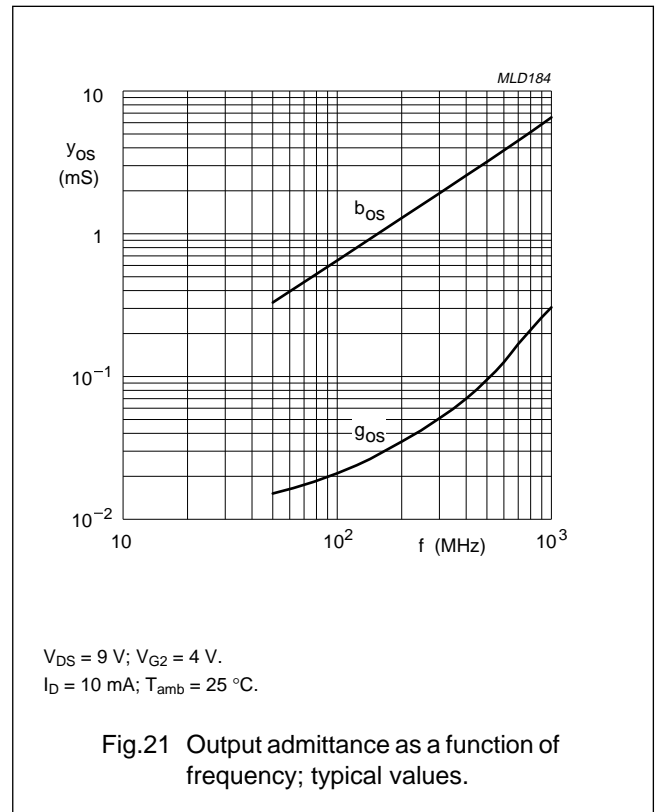
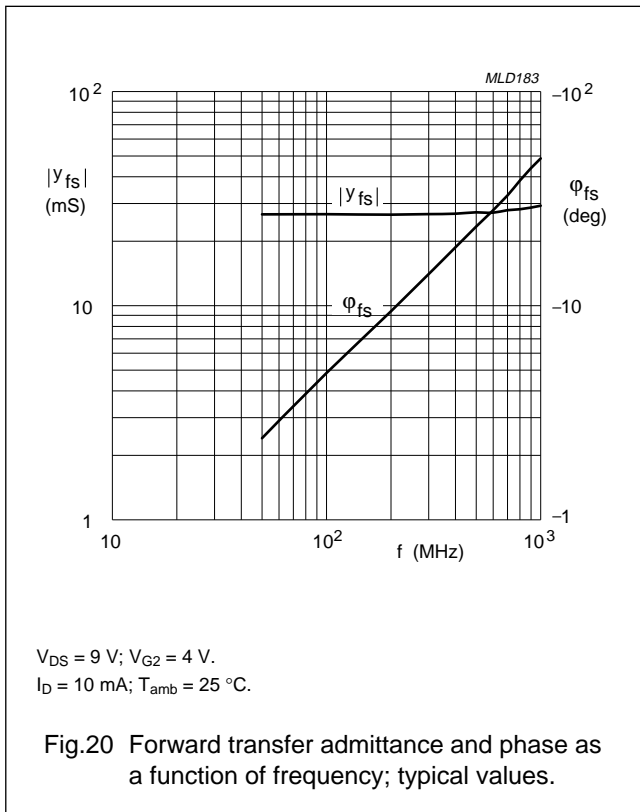
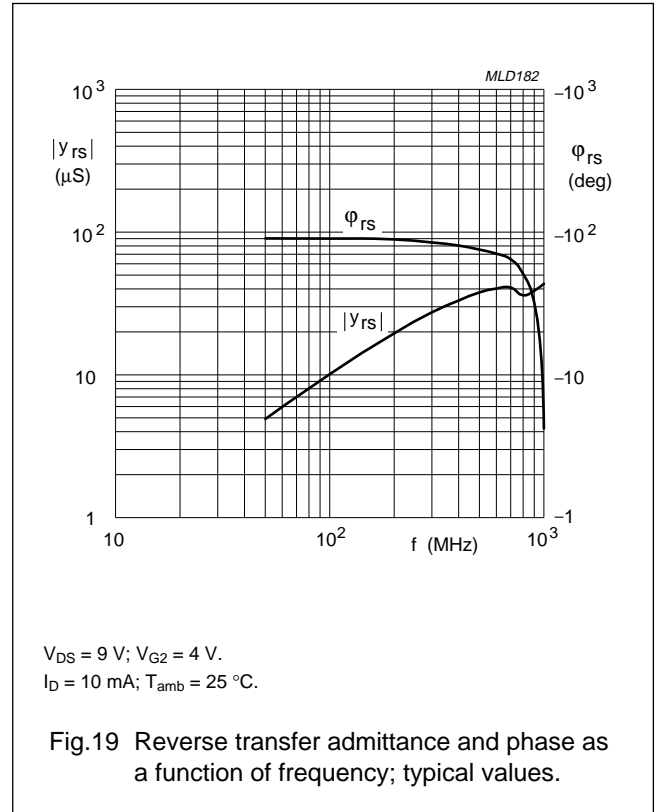
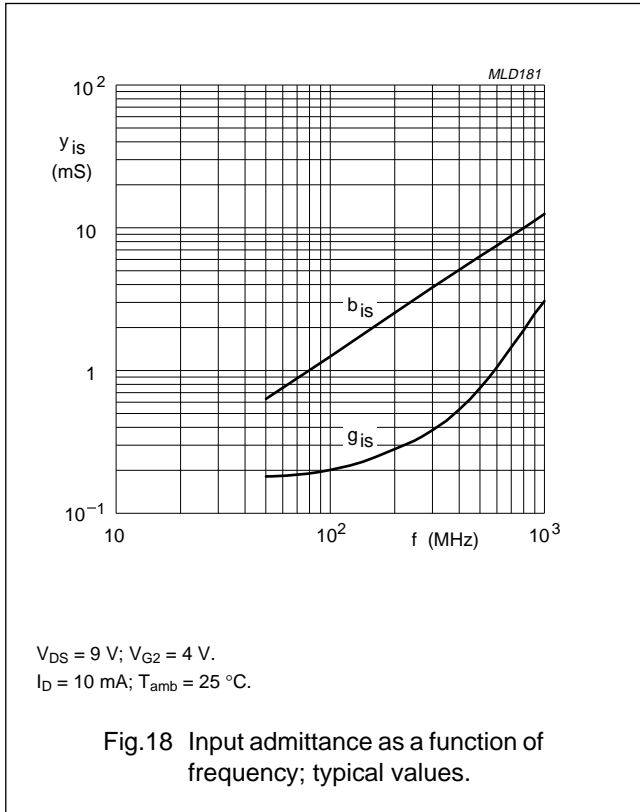

Dual-gate MOS-FET

BF1100WR

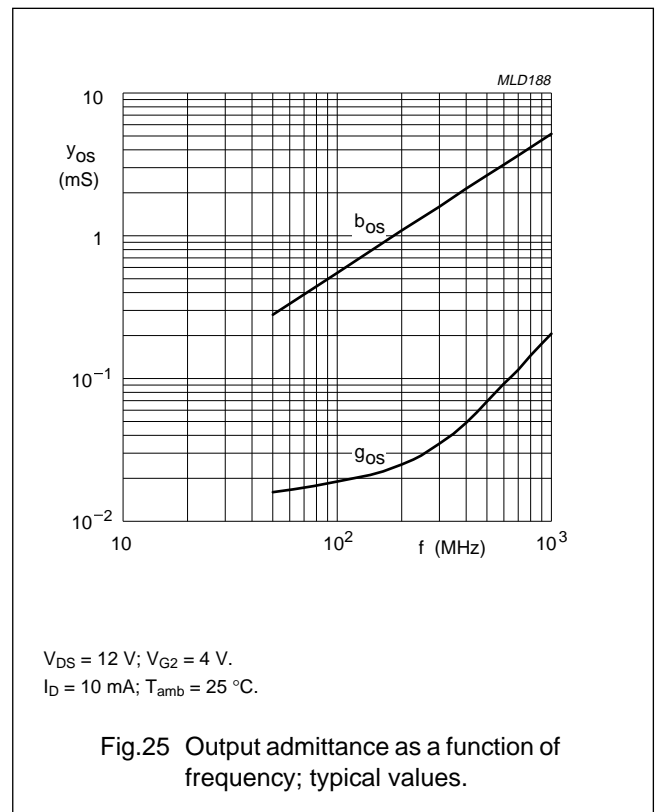
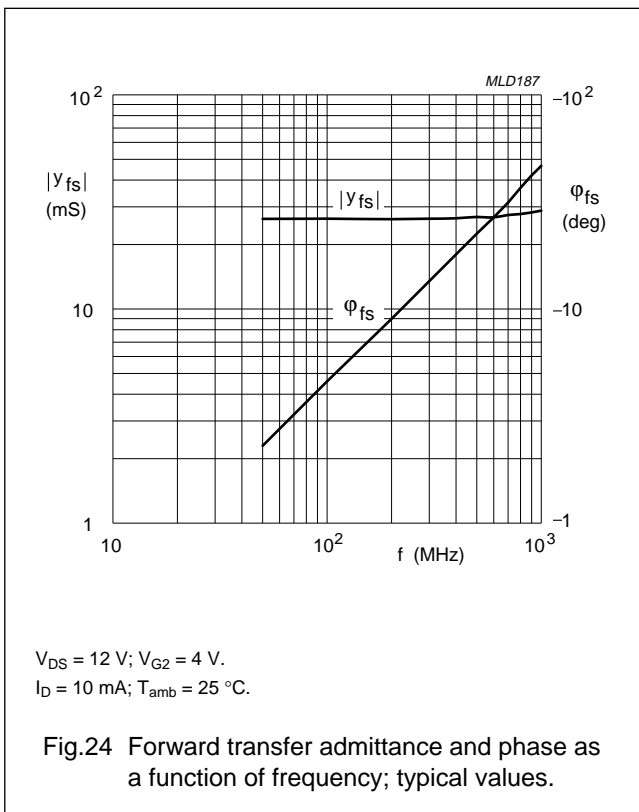
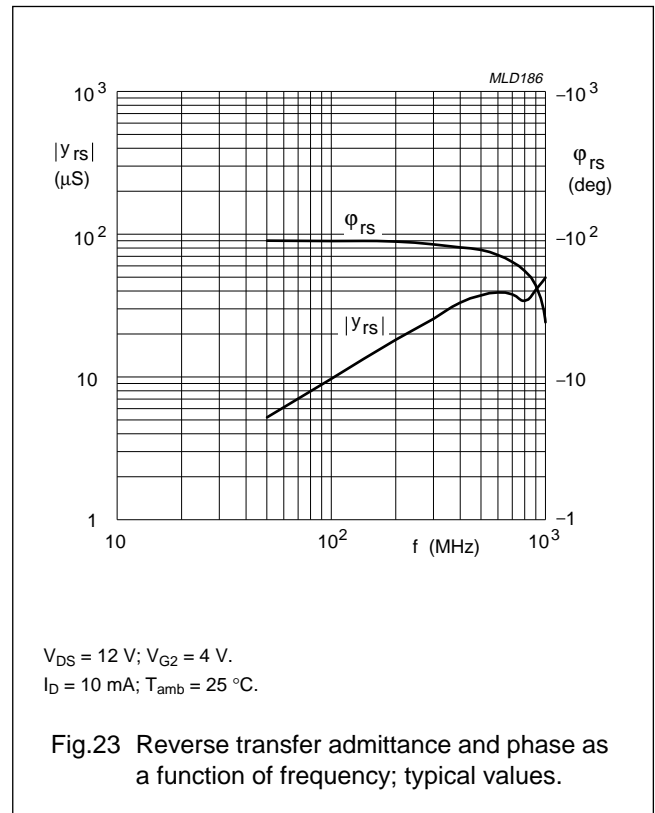
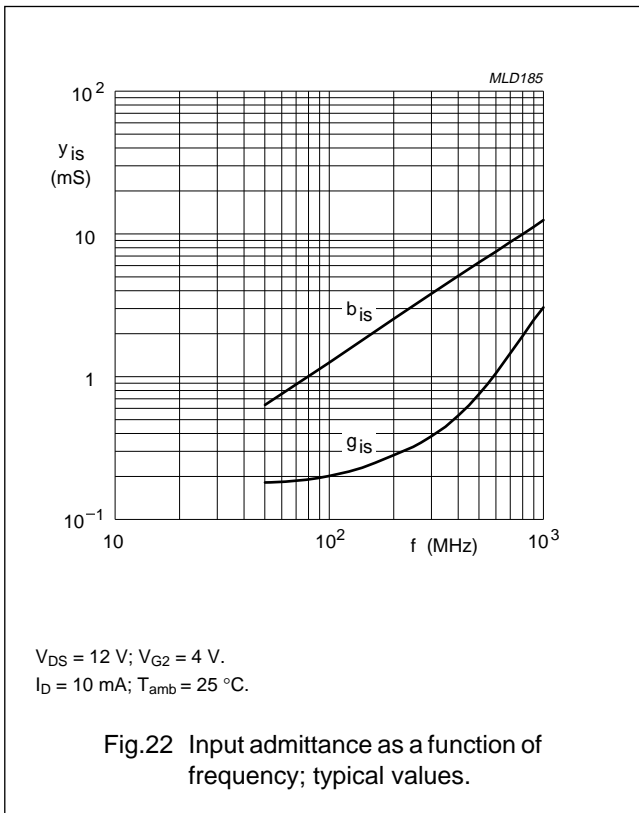

Dual-gate MOS-FET

BF1100WR

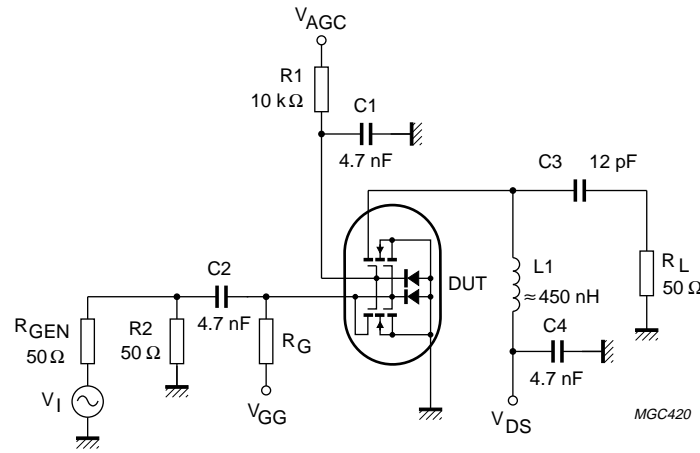

For  $V_{GG} = V_{DS} = 9\text{ V}$ ,  $R_G = 180\text{ k}\Omega$ .  
 For  $V_{GG} = V_{DS} = 12\text{ V}$ ,  $R_G = 250\text{ k}\Omega$ .

Fig.26 Cross-modulation test circuit.

## Dual-gate MOS-FET

## BF1100WR

**Table 1** Scattering parameters:  $V_{DS} = 9\text{ V}$ ;  $V_{G2-S} = 4\text{ V}$ ;  $I_D = 10\text{ mA}$ 

f (MHz)	S <sub>11</sub>		S <sub>21</sub>		S <sub>12</sub>		S <sub>22</sub>	
	MAGNITUDE (ratio)	ANGLE (deg)	MAGNITUDE (ratio)	ANGLE (deg)	MAGNITUDE (ratio)	ANGLE (deg)	MAGNITUDE (ratio)	ANGLE (deg)
50	0.985	-3.9	2.618	175.1	0.001	137.9	1.000	-1.9
100	0.981	-7.3	2.602	170.5	0.001	80.4	0.999	-4.0
200	0.975	-14.4	2.577	160.7	0.002	74.0	0.995	-7.6
300	0.965	-21.6	2.555	151.6	0.002	79.3	0.994	-11.3
400	0.947	-28.3	2.513	141.8	0.003	80.5	0.992	-15.0
500	0.927	-34.9	2.449	133.4	0.003	82.8	0.988	-18.5
600	0.913	-41.7	2.339	124.6	0.003	78.9	0.984	-22.0
700	0.890	-47.9	2.361	115.4	0.003	80.6	0.982	-25.3
800	0.869	-54.0	2.302	106.4	0.003	93.9	0.979	-28.8
900	0.845	-59.7	2.228	97.6	0.003	104.8	0.976	-32.1
1000	0.823	-65.4	2.167	89.6	0.003	129.3	0.974	-35.5

**Table 2** Noise data:  $V_{DS} = 9\text{ V}$ ;  $V_{G2-S} = 4\text{ V}$ ;  $I_D = 10\text{ mA}$ 

f (MHz)	F <sub>min</sub> (dB)	Γ <sub>opt</sub>		r <sub>n</sub>
		(ratio)	(deg)	
800	2.00	0.67	43.9	0.89

**Table 3** Scattering parameters:  $V_{DS} = 12\text{ V}$ ;  $V_{G2-S} = 4\text{ V}$ ;  $I_D = 10\text{ mA}$ 

f (MHz)	S <sub>11</sub>		S <sub>21</sub>		S <sub>12</sub>		S <sub>22</sub>	
	MAGNITUDE (ratio)	ANGLE (deg)	MAGNITUDE (ratio)	ANGLE (deg)	MAGNITUDE (ratio)	ANGLE (deg)	MAGNITUDE (ratio)	ANGLE (deg)
50	0.985	-3.7	2.576	175.3	0.000	125.0	1.000	-1.6
100	0.980	-7.4	2.563	170.9	0.001	111.2	1.000	-3.3
200	0.973	-14.6	2.541	161.6	0.002	83.0	0.997	-6.4
300	0.962	-21.5	2.519	152.9	0.002	85.2	0.996	-9.3
400	0.946	-28.5	2.479	143.5	0.003	79.4	0.995	-12.4
500	0.929	-35.0	2.419	135.5	0.003	78.2	0.991	-15.3
600	0.912	-41.6	2.373	127.2	0.003	80.0	0.989	-18.1
700	0.895	-47.8	2.336	118.7	0.003	83.4	0.987	-20.9
800	0.868	-53.8	2.284	110.0	0.003	91.3	0.985	-23.7
900	0.845	-59.8	2.213	101.6	0.003	95.9	0.983	-26.5
1000	0.823	-65.7	2.160	94.1	0.003	112.2	0.981	-29.3

**Table 4** Noise data:  $V_{DS} = 12\text{ V}$ ;  $V_{G2-S} = 4\text{ V}$ ;  $I_D = 10\text{ mA}$ 

f (MHz)	F <sub>min</sub> (dB)	Γ <sub>opt</sub>		r <sub>n</sub>
		(ratio)	(deg)	
800	2.00	0.66	43.3	0.97

Dual-gate MOS-FET

BF1100WR

PACKAGE OUTLINE

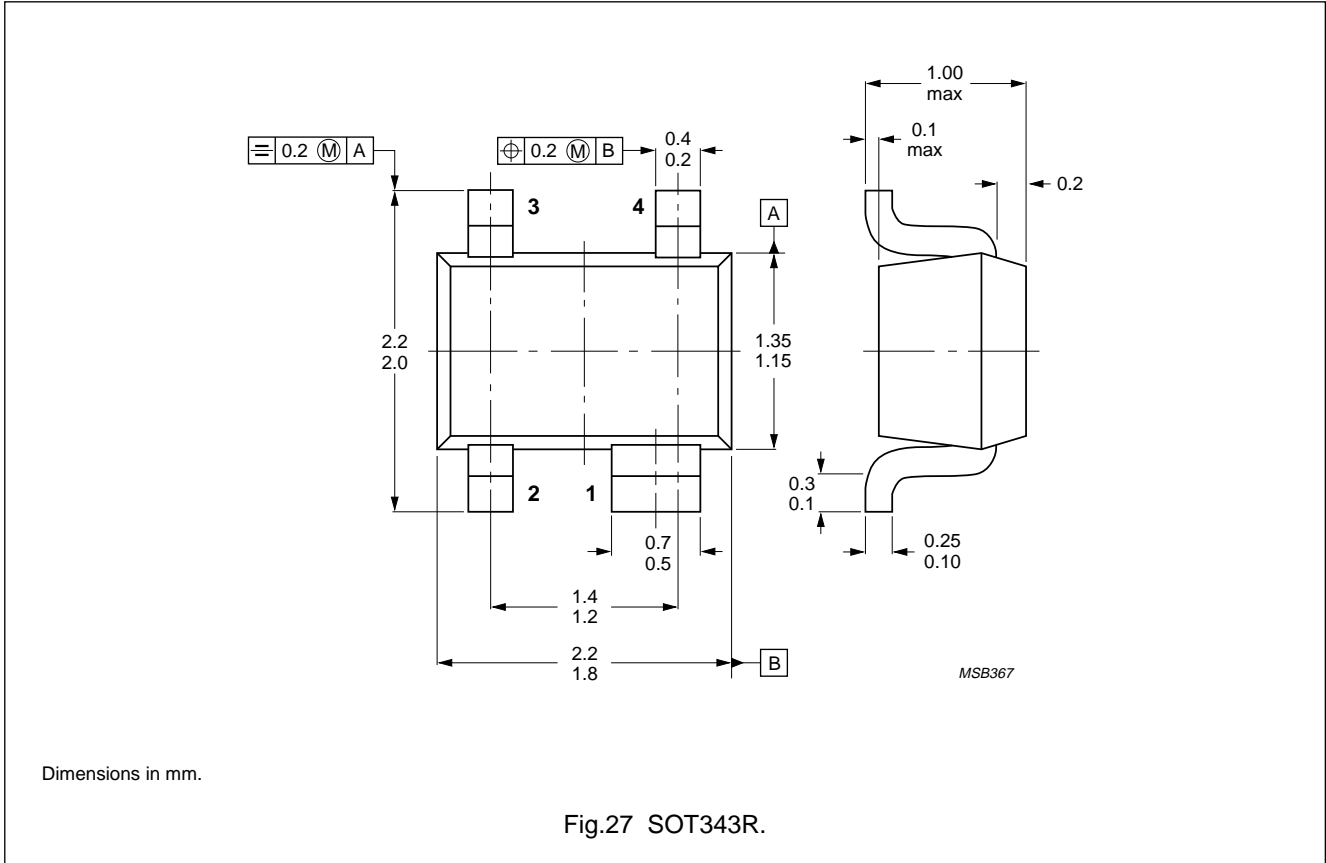

## Dual-gate MOS-FET

BF1100WR

**DEFINITIONS**

<b>Data Sheet Status</b>	
Objective specification	This data sheet contains target or goal specifications for product development.
Preliminary specification	This data sheet contains preliminary data; supplementary data may be published later.
Product specification	This data sheet contains final product specifications.
<b>Limiting values</b>	
Limiting values given are in accordance with the Absolute Maximum Rating System (IEC 134). Stress above one or more of the limiting values may cause permanent damage to the device. These are stress ratings only and operation of the device at these or at any other conditions above those given in the Characteristics sections of the specification is not implied. Exposure to limiting values for extended periods may affect device reliability.	
<b>Application information</b>	
Where application information is given, it is advisory and does not form part of the specification.	

**LIFE SUPPORT APPLICATIONS**

These products are not designed for use in life support appliances, devices, or systems where malfunction of these products can reasonably be expected to result in personal injury. Philips customers using or selling these products for use in such applications do so at their own risk and agree to fully indemnify Philips for any damages resulting from such improper use or sale.