

---

# HA12206NT

Audio Signal Processor for Cassette Deck

# HITACHI

ADE-207-198B (Z)

3rd Edition  
Jun. 1999

---

## Description

HA12206NT is silicon monolithic bipolar IC providing music sensor system, ALC, REC equalizer system and each electronic control switch in one chip.

## Functions

- REC equalizer     × 2 channel
- Line Amp.         × 2 channel
- ALC (Automatic Level Control)
- MS (Music Sensor)
- Each electronic control switch to change REC equalizer, bias, etc.
- REC mute

## Features

- REC equalizer is very small number of external parts, built-in 2 types of frequency characteristics.
- Correspondence with normal position (TYPE I) / high position (TYPE II).
- TYPE I / TYPE II and PB equalizer fully electronic control switching built-in.
- Controllable from direct micro-computer output.
- Available to reduce substrate-area because of high integration and small external parts.

# HA12206NT

**Pin Description, Equivalent Circuit** ( $V_{CC} = 7.0V$ ,  $V_{EE} = -7.0V$ ,  $T_a = 25^\circ C$ , No signal, The value in the table show typical value.)

Pin No.	Pin Name	Note	Equivalent Circuit	Pin Description
2	PB-Ain (R)	$V=0$		A Deck PB input
29	PB-Ain (L)			
4	PB-Bin (R)			B Deck PB input
27	PB-Bin (L)			
5	REC-in (R)			REC input
26	REC-in (L)			
9	EQ-in (R)			Equalizer input
22	EQ-in (L)			
12	MIMS			MS Gain control
3	AB out (R)	$V = 0$		Time constant for NAB standard
28	AB out (L)			
6	ATT (R)	$V = 0$		Variable impedance for attenuation
25	ATT (L)			
7	RPOUT (R)			REC or PB output
24	RPOUT (L)			

**Pin Description, Equivalent Circuit** ( $V_{CC} = 7.0V$ ,  $V_{EE} = -7.0V$ ,  $T_a = 25^\circ C$ , No signal, The value in the table show typical value.) (cont)

Pin No.	Pin Name	Note	Equivalent Circuit	Pin Description
8	ADD in (R)			Adder input
23	ADD in (L)			
10	EQOUT (R)	$V = 0V$		Equalizer output
21	EQOUT (L)			
11	IREF	$V = 1.2V$		Equalizer reference current input
13	DET MS	$V = V_{CC} - 4.2V$		Time constant for rectifier
15	DET ALC	$V = 2.3V$		
16	MS			MS output

# HA12206NT

**Pin Description, Equivalent Circuit** ( $V_{CC} = 7.0V$ ,  $V_{EE} = -7.0V$ ,  $T_a = 25^\circ C$ , No signal, The value in the table show typical value.) (cont)

Pin No.	Pin Name	Note	Equivalent Circuit	Pin Description
17	Acr	$V = 0V$		Mode control
18	Bcr			
19	REC MUTE			
20	REC / A / B	$V = 2.5V$		
1	$V_{EE}$			$V_{EE}$ pin
14	$V_{CC}$			$V_{CC}$ pin
30	GND			GND pin

Block Diagram

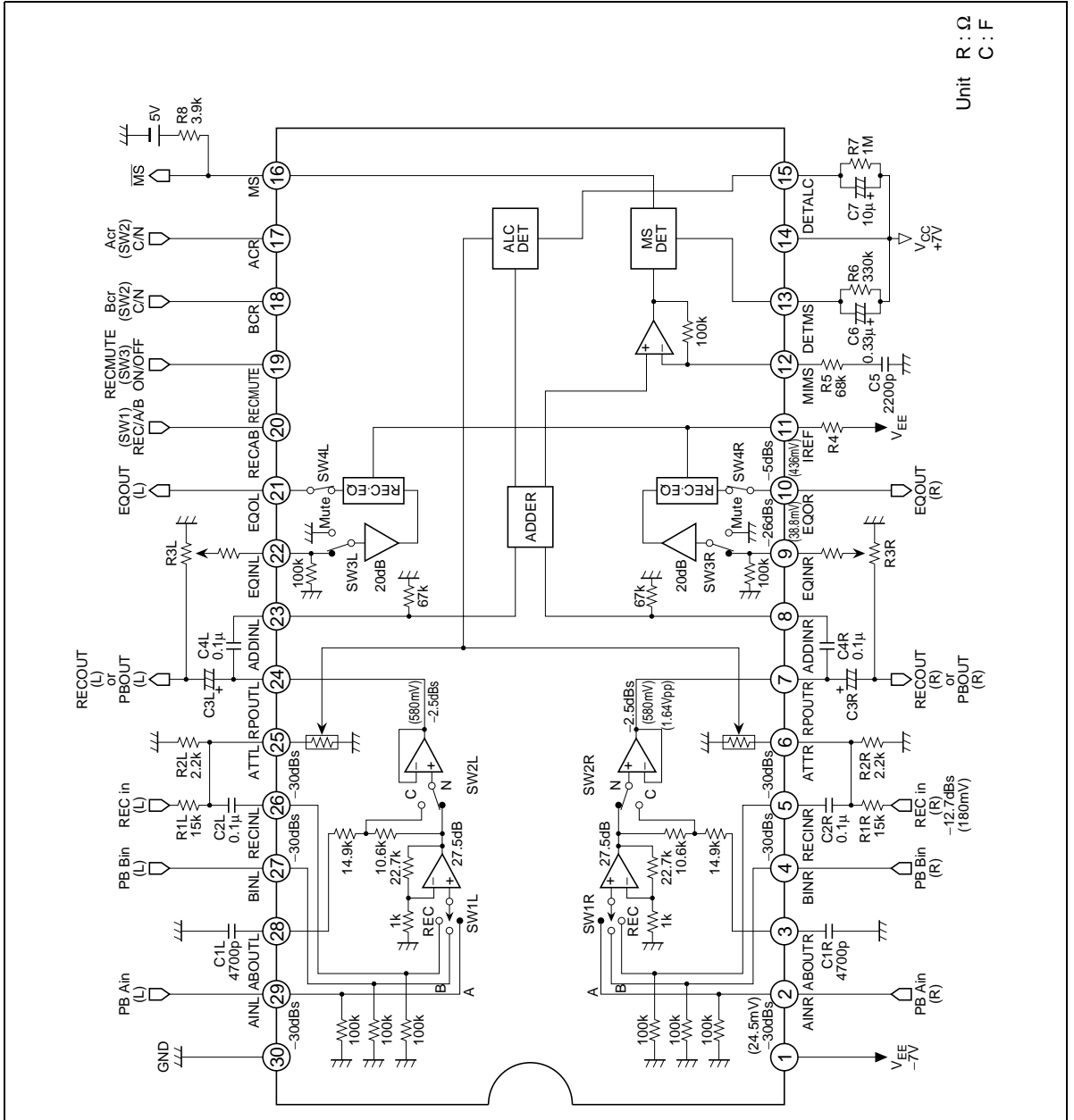

Unit R : Ω  
C : F

---

# HA12206NT

---

## Truth Table

### Parallel Data Format

		NAB SW Position (SW 2)			
		REC / $\bar{A}$ / $\bar{B}$ (Pin 20)			
Acr (Pin 17)	Bcr (Pin 18)	L	M	H	REC-EQ Mode
L	L	TYPE I	TYPE I	TYPE I	TYPE I
L	H	TYPE II	TYPE I	TYPE I	TYPE II
H	L	TYPE I	TYPE II	TYPE I	TYPE I
H	H	TYPE II	TYPE II	TYPE I	TYPE II
Line Amp (SW 1)		B	A	REC	
ALC		OFF	OFF	*1	
REC-EQ Behind (SW 4)		OFF	ON	ON	

Note: 1. Follow the position of REC-MUTE pin.

REC-MUTE (Pin 19)	REC-EQ Before (SW 3)	ALC
L	Active	ON
H	MUTE	OFF

### Control Pin Position Under the Open Case

Acr (Pin 17)	L
Bcr (Pin 18)	L
REC-MUTE (Pin 19)	L
REC / A / B (Pin 20)	M

Test Conditions

Test No.	Symbol	Set No.	SG.	Input	Output	Measure	Other
1	I <sub>q</sub>	1	—	—	—	—	I <sub>q</sub> =I (DC SOURCE 3)
2-1	(V/L)	Acr	2	10kHz, -30dBs Ain	PBOUT	AC VM2	
		Bcr	3	10kHz, -30dBs Bin	PBOUT	AC VM2	V(AC VM2)
		REC-MUTE	4	1kHz, -26dBs EQin	EQOUT	AC VM2	(dB)
2-2	(V/IM)	RECAB	5	1kHz, -30dBs Bin	RPOUT	AC VM2	
		RECAB	5	1kHz, -30dBs Ain	RPOUT	AC VM2	V(AC VM2)
							(dB)
2-3	(V/IH)	Acr	2	10kHz, -30dBs Ain	RPOUT	AC VM2	
		Bcr	3	10kHz, -30dBs Bin	RPOUT	AC VM2	V(AC VM2)
		REC-MUTE	4	1kHz, -26dBs EQin	EQOUT	AC VM2	(dB)
		RECAB	5	1kHz, -30dBs RECin	RPOUT	AC VM2	
3-1	G <sub>V</sub> (1)	6	1kHz, -30dBs	Ain	RPOUT	AC VM1	G <sub>V</sub> =20 log {V(AC VM2) / V(AC VM1)}
						AC VM2	
3-2	G <sub>V</sub> (2)	7	1kHz, -30dBs	Bin	RPOUT	AC VM1	G <sub>V</sub> =20 log {V(AC VM2) / V(AC VM1)}
						AC VM2	
3-3	G <sub>V</sub> (3)	8	10kHz, -30dBs	Bin	RPOUT	AC VM1	G <sub>V</sub> =20 log {V(AC VM2) / V(AC VM1)}
						AC VM2	
3-4	G <sub>V</sub> (4)	9	1kHz, -30dBs	RECin	RPOUT	AC VM2	V <sub>i</sub> =V(AC VM2) at SW5, SW6=REC
4	V <sub>omax</sub>	6	1kHz	Ain	RPOUT	AC VM2	V <sub>o</sub> =V(AC VM2) at T.H.D=1%
5-1	THD(1)	6	1kHz, -30dBs	Ain	RPOUT	Distortion Analyzer	400 to 30kHz BPF
5-2	THD(2)	9	1kHz, -0.7dBs	RECin	RPOUT	Distortion Analyzer	400 to 30kHz BPF

## Test Conditions (cont)

Test No.	Symbol	Set No.	SG.	Input	Output	Measure	Other
6-1	S/N (1)	6	—	—	RPOUT	—	$S/N=20 \log \{580mV / \sqrt{V(\text{Noise})}\}$ CCIR / ARM
6-2	S/N (2)	9	—	—	RPOUT	—	$S/N=20 \log \{580mV / \sqrt{V(\text{Noise})}\}$ CCIR / ARM
7	CT R/L	10	1kHz, -18dBs* Ain	RPOUT	AC VM2	CT=20 log {580mV / V(AC VM2)}	
8	CT A/B	11	1kHz, -18dBs* Ain/Bin	RPOUT	AC VM2	CT=20 log {580mV / V(AC VM2)}	
9	ALC	12	1kHz, -0.7dBs RECin	RPOUT	AC VM2	ALC=20 log {V(AC VM2) / 580mV}	
10	V <sub>ON</sub>	6	5kHz Ain	RPOUT	AC VM2	V <sub>ON</sub> =20 log {V(AC VM2) / 580mV} at DC VM=1	
11	V <sub>OL</sub>	6	1kHz, -30dBs Ain	RPOUT	DC VM		
12-1	G <sub>v</sub> REC N1	13	1kHz, -46dBs EQin	EQout	AC VM2	G <sub>v</sub> REC=20 log {V(AC VM2) / V(AC VM1)}	
12-2	G <sub>v</sub> REC N2	13	8kHz, -46dBs EQin	EQout	AC VM2	G <sub>v</sub> REC=20 log {V(AC VM2) / V(AC VM1)}	
12-3	G <sub>v</sub> REC N3	13	12kHz, -46dBs EQin	EQout	AC VM2	G <sub>v</sub> REC=20 log {V(AC VM2) / V(AC VM1)}	
13-1	G <sub>v</sub> REC C1	13	1kHz, -46dBs EQin	EQout	AC VM2	G <sub>v</sub> REC=20 log {V(AC VM2) / V(AC VM1)}	
13-2	G <sub>v</sub> REC C2	13	8kHz, -46dBs EQin	EQout	AC VM2	G <sub>v</sub> REC=20 log {V(AC VM2) / V(AC VM1)}	
13-3	G <sub>v</sub> REC C3	13	12kHz, -46dBs EQin	EQout	AC VM2	G <sub>v</sub> REC=20 log {V(AC VM2) / V(AC VM1)}	
14	R-MUTE ATT	14	1kHz, -14dBs* EQin	EQout	AC VM2	R-MUTE ATT=20 log {436mV / V(AC VM2)}	
15	V <sub>max</sub> REC	13	1kHz EQin	EQout	AC VM2	at T.H.D.=1%	
16	THD REC	13	1kHz, -26dBs EQin	EQout	EQout	Distortion 400 to 30kHz BPF Analyzer	
17	S/N REC	13	—	EQout	EQout	Noise Meter	$S/N=20 \log \{436mV / \sqrt{V(\text{AC VM2})}\}$

Note: or large level without dipping



Test Conditions (cont)

SW Position (Pre-Set for Each TEST)

Set No.	SW-Position										DC-SOURCE(V)			
	1	2	3	4	5	6	7	8	9	10	1	2	3	4
1	OFF	*1	*1	*1	*1	*1	L	L	L	M	2.5V	5V	-7V	-7V
2	*2	A	A	*2	RP	RP	M	L	L	OFF	0 to V <sub>CC</sub>	5V	-7V	-7V
3	*2	B	B	*2	RP	RP	L	M	L	L	0 to V <sub>CC</sub>	5V	-7V	-7V
4	*2	EQ	EQ	*2	EQ	EQ	L	L	M	H	0 to V <sub>CC</sub>	5V	-7V	-7V
5	*2	B	B	*2	RP	RP	L	L	L	M	0 to V <sub>CC</sub>	5V	-7V	-7V
6	*2	A	A	*2	RP	RP	L	L	H	M	2.5V	5V	-7V	-7V
7	*2	B	B	*2	RP	RP	L	L	H	L	*1	5V	-7V	-7V
8	*2	B	B	*2	RP	RP	L	H	H	L	*1	5V	-7V	-7V
9	*2	REC	REC	*2	RP	RP	L	L	H	H	*1	5V	-7V	-7V
10	R↔L	A	A	L↔R	RP	RP	L	L	H	M	2.5V	5V	-7V	-7V
11	*2	A↔B	A↔B	*2	RP	RP	L	L	H	L↔M	2.5V	5V	-7V	-7V
12	*2	REC	REC	*2	RP	RP	L	L	L	H	*1	5V	-7V	-7V
13	*2	EQ	EQ	*2	EQ	EQ	L	L	L	M	2.5V	5V	-7V	-7V
14	*2	EQ	EQ	*2	EQ	EQ	L	L	H	M	2.5V	5V	-7V	-7V
15	*2	A	A	*2	RP	RP	L	L	H	M	2.5V	5V	-6V	-6V
16	*2	EQ	EQ	*2	EQ	EQ	L	L	L	M	2.5V	5V	-6V	-6V

Note: 1. Either will do

2. Measured channel Lch or Rch

---

# HA12206NT

---

## Functional Description

### Power Supply Range

Table 1 Supply Voltage

Item	Power Supply Range		
	$V_{CC}$	$V_{EE}$	$ V_{CC}  -  V_{EE} $
Single Supply	6.0V to 7.5V	-7.5V to -6.0V	Inside 1.0V

Note: HA12206NT is designed to operate on split supply.

As  $V_{EE}$  pin is joined the substrate of chip, there is the possibility of latch-up in such case that the other pin is supplied a voltage and  $V_{EE}$  pin is open.

Therefore please use as  $V_{EE}$  pin become the lowest voltage of low impedance all the time. When power supply is thrown into this IC, that caution is necessary especially.

### Operating Mode Control

HA12206NT provides fully electronic switching circuits. And each operating mode control is controlled by parallel data (DC voltage).

Table 2 shows the control voltage of each control input pin.

Table 2 Control Voltage

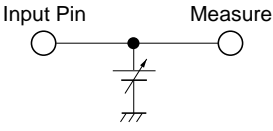
Pin No.	Lo	Mid	Hi	Unit	Test Condition
17, 18, 19	0.0 to 1.0	—	4.0 to $V_{CC}$	V	
20	0.0 to 1.0	2.0 to 3.0	4.0 to $V_{CC}$	V	

- Note:
1. Each pin is pulled down with 100k $\Omega$  internal resistor. 17 to 19 pins are low-level, 20 pin is mid-level, when each pin is open.
  2. Over shoot level and under shoot level of input signal must be the standardized.  
(High: Less than  $V_{CC}$ , Low: More than  $-0.2V$ )

**PB Equalizer**

By switching logical input level of pin17 (for Ain) or pin18 (for Bin), you can equalize corresponding to tape position at play back mode.

Frequency characteristics of high position (TYPE II) depends on capacitor C1 on the block diagram figure.

Figure 1 is shown by a motive of the NAB standard.

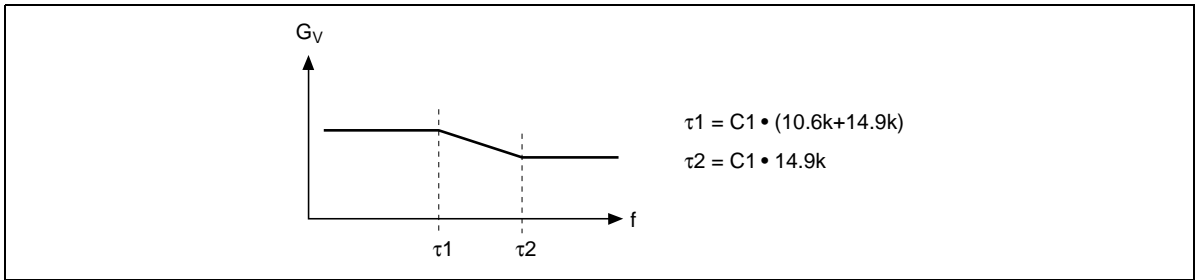

**Figure 1 Frequency Characteristics of PB Equalizer**

**Music Sensor**

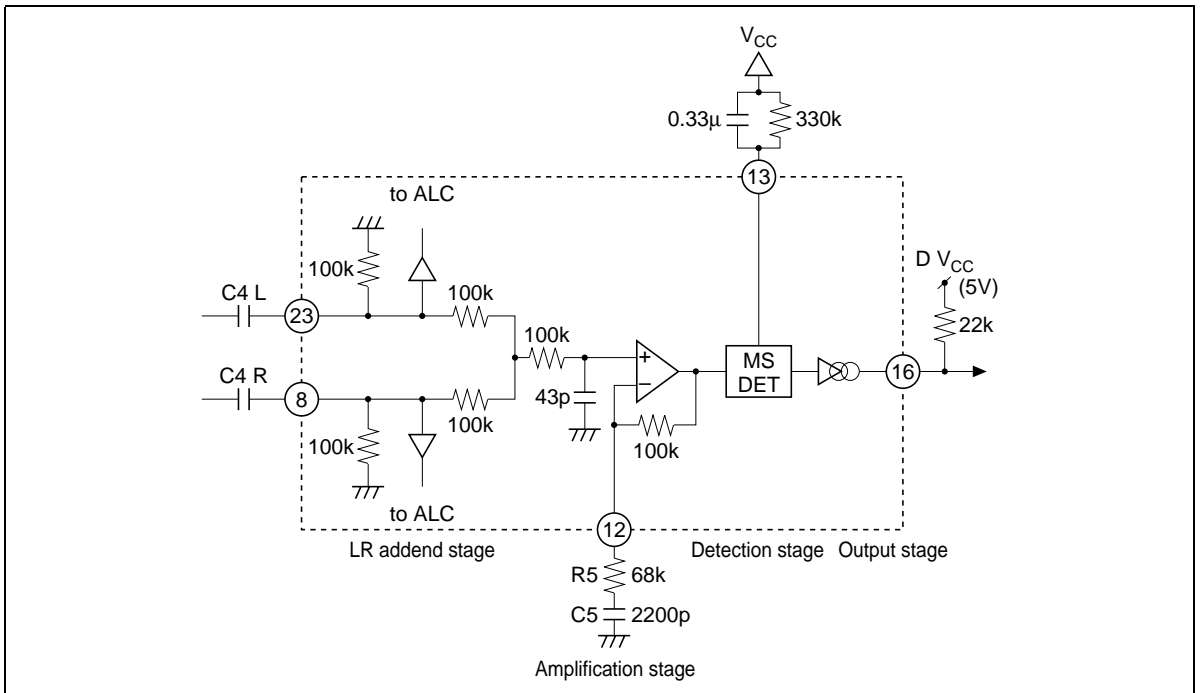

**Figure 2 Music Sensor Block Diagram**

## The Sensitivity of Music Sensor

Frequency characteristics of MS amplification stage is shown by figure 3.

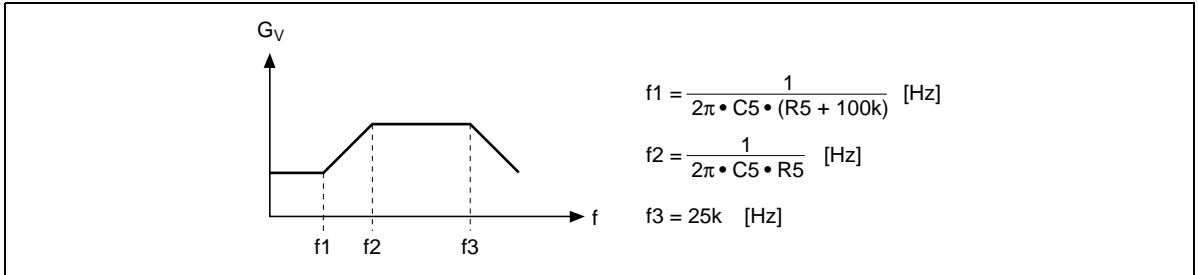

**Figure 3 Frequency Characteristic of MS AMP**

Occasion of the external component of figure 2, f1 is 430Hz and f2 is 1.1kHz.

As the MS sensitivity is prescribed at 5kHz, this stage's gain is 7.9dB. But in only one-sided channel input case, this gain is considered as -6dB down, because the other channel input pin is imaginary earth. That is, the gain from RPOUT to MSDET is 1.86dB.

As the detection sensitivity at MSDET is fixed 130mVrms, the sensitivity at RPOUT (8 pin or 23 pin) is calculated by the following formula.

$$\frac{130\text{mV}}{10^{\frac{1.86}{20}}} = 105\text{mV}$$

Because of RPOUT=580mVrms=0dB, therefore, the MS sensitivity becomes -14.8dB.

That is the detection level.

## Time Constant of Detection

Figure 4 (1) generally shows that detection time is in proportion to value of capacitor C16. But, with Attack\*<sup>1</sup> and Recovery\*<sup>2</sup> the detection time differs exceptionally.

- Note: 1. Attack : Non-music → Music  
 2. Recovery : Music → Non-music

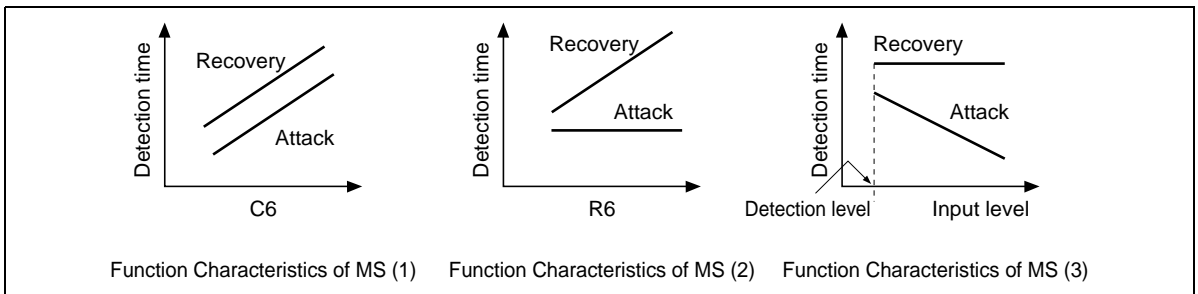

**Figure 4 Function Characteristic of MS**

Like the figure 4 (2), Recovery time is variably possible by value of resistor R6. But Attack time gets about fixed value. Attack time has dependence by input level. When a large signal is inputted, Attack time is short tendency.

**Music Sensor Output (MSOUT)**

Because MS out pin is connected to the collector of NPN type directly, it is requested to use pull up resistor (RL=10k to 22kΩ)

Output level is “High” sensing no signal. And output level is “Low” sensing signal.

Please take notice of MS Low level voltage (GND+0.9V).

The connected supply voltage must be less than V<sub>cc</sub> voltage, with MSOUT pull up resistor.

**Automatic Level Control (ALC)**

ALC is the input decay rate variable system.

It has internal variable resistors of pin6 (pin25) by RECOUT signal that is inputted to pin8 (pin23).

The operation is similitude to MS, detected by pin15.

The signal input pin is pin5 (pin26). Resistor R1, R2 and capacitor C2, external components, for the input circuit are commended as figure 6. These are requested to use value of the block diagram figure for performance maintenance of S/N, T.H.D. etc.

Figure 5 shows the relation with R1 front REC IN point and RPOUT.

ALC operation level is 775mVrms {standard level (580mVrms) +2.5dB}. And it is designed to operate from 0dB to +15dB as 775mVrms=0dB.

Adopted maximum value circuit, ALC is operated by a large channel of a signal.

ALC on/off is linked with REC mute. When REC mute is on, ALC is off.

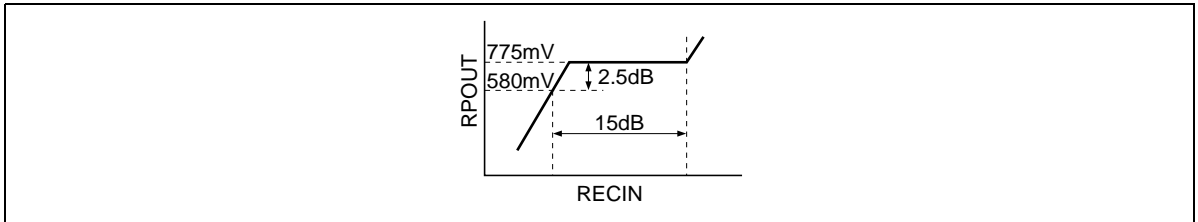

**Figure 5 ALC Operation Level**

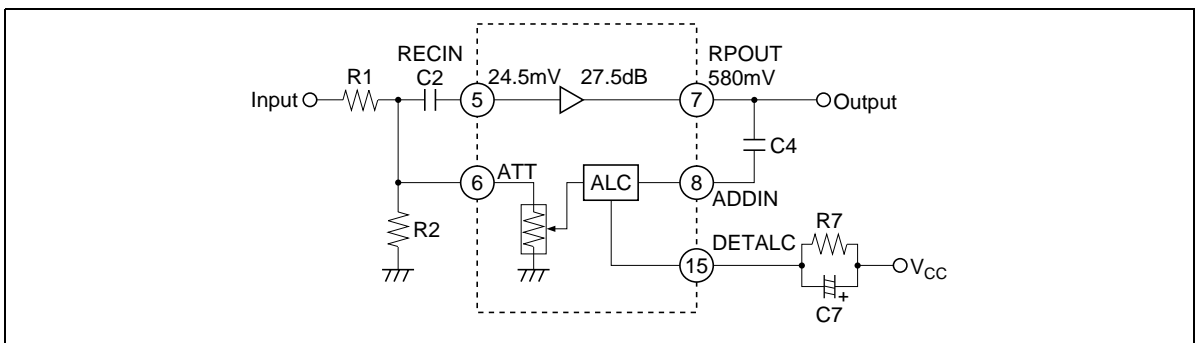

**Figure 6 ALC Block Diagram**

**REC-Equalizer**

REC mute is located at input-part of REC-equalizer. Therefore it has realized low pop noise.

But because there is deference DC offset at the each mode of REC-equalizer, it is necessary for a coupling capacitor between EQOUT pin and recording head.

---

## HA12206NT

---

### Absolute Maximum Rating (Ta = 25°C)

Item	Symbol	Rating	Unit	Note
Max supply voltage	V <sub>CC</sub> max	+8	V	
Max supply voltage	V <sub>EE</sub> max	-8	V	
Power dissipation	Pd	500	mW	Ta≤75°C
Operating temperature	Topr	-40 to +75	°C	
Storage temperature	Tstg	-55 to +125	°C	
Operating voltage	Vopr	V <sub>CC</sub> =-V <sub>EE</sub> =6 to 7.5	V	

---

Electrical Characteristics (Ta=25°C, V<sub>CC</sub>=±7.0V (V<sub>EE</sub>), 0dB=580mVrms=-2.52dBs (V<sub>out</sub>))

Item	Symbol	Min	Typ	Max	Unit	Test Condition				Application Terminal							
						IC Condition				Input				Output			
						REC/ A/B	MUTE	ACR	Bcr	f <sub>in</sub> (Hz)	V <sub>in</sub> (dBs)	Other	R	L	R	L	COM
Quiescent current	I <sub>Q</sub>	10.0	16.0	22.0	mA	A	Active	TYPE I	TYPE I	—	—	No signal	14				
Logical threshold	V <sub>IL</sub>	-0.2	—	1.0	V	—	—	—	—	—	—	—	17 to 20				
	V <sub>IM</sub>	2.0	—	3.0	V	—	—	—	—	—	—	—	20				
	V <sub>IH</sub>	4.0	—	V <sub>CC</sub>	V	—	—	—	—	—	—	—	17 to 20				
Line amp. gain	G <sub>V</sub> (1)	26.0	27.5	29.0	dB	A	Mute	TYPE I	TYPE I	1k	-30	0dB	2	29	7	24	
	G <sub>V</sub> (2)	26.0	27.5	29.0	dB	B	Mute	TYPE I	TYPE I	1k	-30	0dB	4	27	7	24	
	G <sub>V</sub> (3)	20.9	22.9	24.9	dB	B	Mute	TYPE I	TYPE II	10k	-30	0dB	4	27	7	24	
	G <sub>V</sub> (4)	26.0	27.5	29.0	dB	REC	Mute	TYPE I	TYPE I	1k	-30	0dB	5	26	7	24	
Maximum output	V <sub>omax</sub>	12.0	13.0	—	dB	A	Mute	TYPE I	TYPE I	1k	—	THD=1%	2	29	7	24	1
THD	THD(1)	—	0.05	0.3	%	A	Mute	TYPE I	TYPE I	1k	-30	0dB, BW 400Hz to 30kHz	2	29	7	24	
	THD(2)	—	1.0	3.0	%	REC	Active	TYPE I	TYPE I	1k	-0.7	+12dB (ALC ON) BW 400Hz to 30kHz	5	26	7	24	2
Signal to noise ratio	S/N(1)	70	78	—	dB	A	Mute	TYPE I	TYPE I	—	—	Rg=10kΩ, CC/IR/ARM S=580mVrms	2	29	7	24	
	S/N(2)	73	81	—	dB	REC	Mute	TYPE I	TYPE I	—	—	Rg=2.2kΩ, CC/IR/ARM S=580mVrms	2	29	7	24	
Channel separation	CT R/L	70	80	—	dB	A	Mute	TYPE I	TYPE I	1k	-18	+12dB	2	29	24	7	
	CT A/B	60	70	—	dB	A/B	Mute	TYPE I	TYPE I	1k	-18	+12dB	2	29	7	24	
ALC operation level	ALC	0.0	2.5	5.5	dB	REC	Active	TYPE I	TYPE I	1k	-0.7	+12dB (ALC ON)	5	26	7	24	2, 3
	V <sub>ON</sub>	-18.7	-14.7	-10.7	dB	A	Mute	TYPE I	TYPE I	5k	—	—	2	29	7	24	3
MS output low level	V <sub>OL</sub>	—	1.0	1.5	V	A	Mute	TYPE I	TYPE I	—	—	—	2	29	7	24	16

Note: 1. V<sub>CC</sub>(V<sub>EE</sub>) = ±6.0V

2. From REC in point

3. For inputting signal to one side channel

# HA12206NT

Electrical Characteristics (Ta=25°C, V<sub>CC</sub>=±7.0V (V<sub>EE</sub>), 0dB=580mVrms=-2.52dBs (Vout)) (cont)

Item	Symbol	Min	Typ	Max	Unit	Test Condition				Application Terminal						
						IC Condition		EQin (dBs)		Input		Output				
						REC/ A/B	REC- MUTE	Acr	Bcr	fin (Hz)	Other	R	L	R	L	COM
REC-EQ frequency response	G <sub>V</sub> REC-N1	18.7	20.2	21.7	dB	A	Active	TYPE I	TYPE I	1k	-46	9	22	10	21	
Normal speed Normal tape	G <sub>V</sub> REC-N2	23.1	25.1	27.1	dB	A	Active	TYPE I	TYPE I	8k	-46	9	22	10	21	
	G <sub>V</sub> REC-N3	28.4	31.4	34.4	dB	A	Active	TYPE I	TYPE I	12k	-46	9	22	10	21	
REC-EQ frequency response	G <sub>V</sub> REC-C1	22.6	24.1	25.6	dB	A	Active	TYPE I	TYPE II	1k	-46	9	22	10	21	
Normal speed Chrom tape	G <sub>V</sub> REC-C2	28.5	30.5	32.5	dB	A	Active	TYPE I	TYPE II	8k	-46	9	22	10	21	
	G <sub>V</sub> REC-C3	33.2	36.4	39.4	dB	A	Active	TYPE I	TYPE II	12k	-46	9	22	10	21	
REC-MUTE attenuation	R-MUTE ATT	70	80	—	dB	A	Mute	TYPE I	TYPE I	1k	-14 +12dB	9	22	10	21	
REC-EQ maximum output	V <sub>omax</sub> REC	4.0	7.0	—	dBs	A	Active	TYPE I	TYPE I	1k	—	9	22	10	21	4
REC-EQ THD	THD REC	—	0.35	0.7	%	A	Active	TYPE I	TYPE I	1k	-26	9	22	10	21	
REC-EQ S/N	S/N REC	52	60	—	dB	A	Active	TYPE I	TYPE I	—	—	9	22	10	21	Rg=5.1kΩ, A-WTG S=-5dBs

Note: 4. V<sub>CC</sub>=±6.0V (V)



Test Circuit

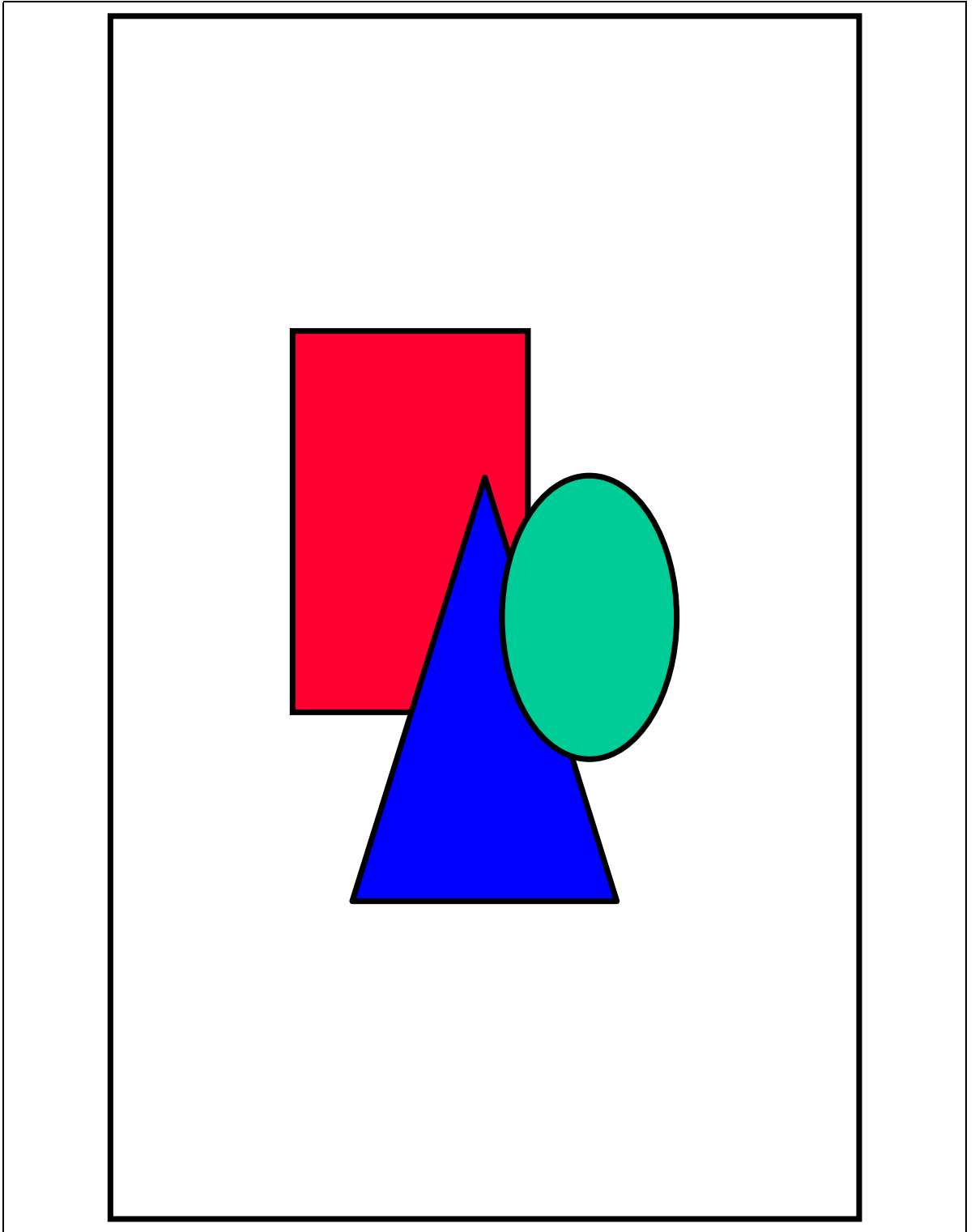

## Characteristic Curves

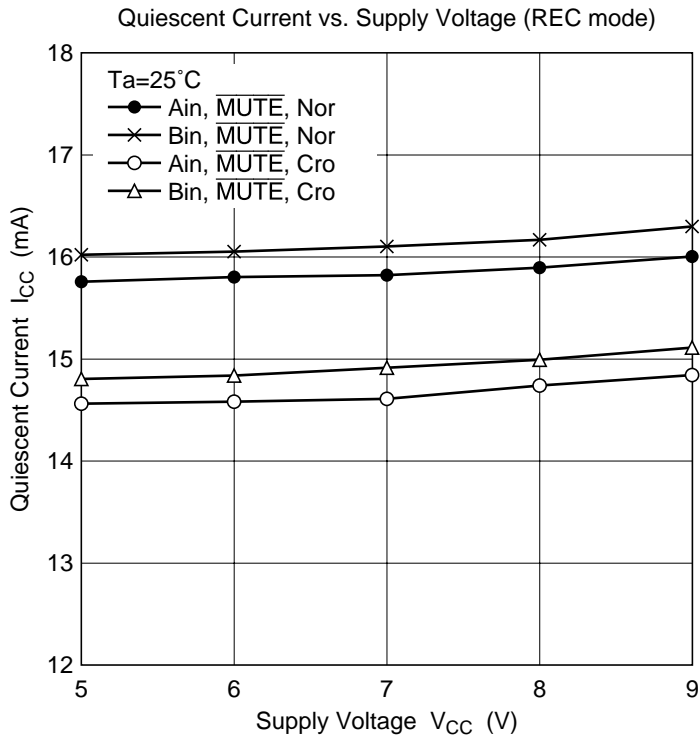
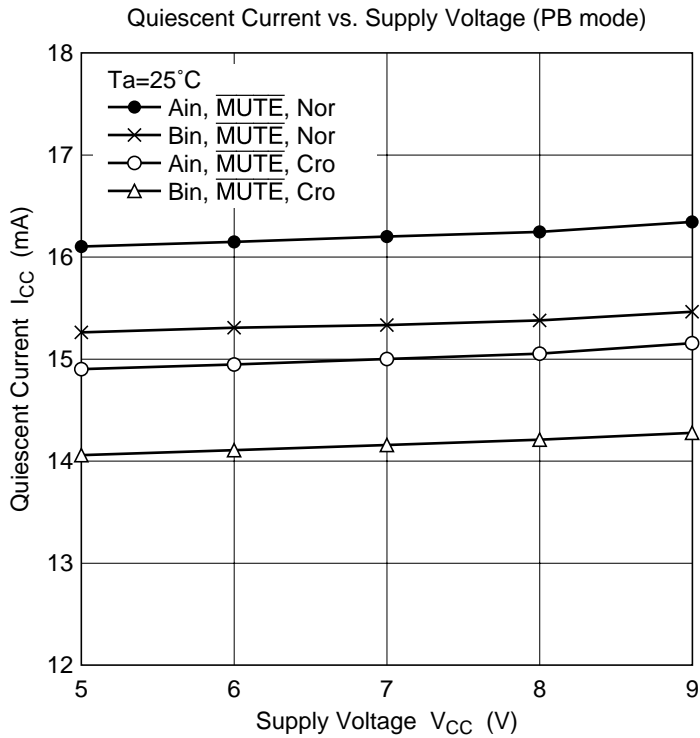

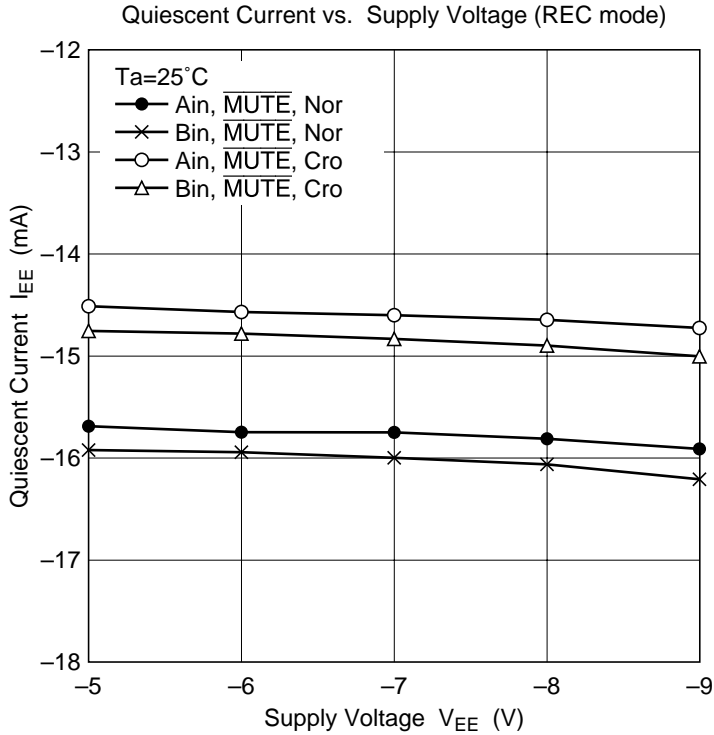
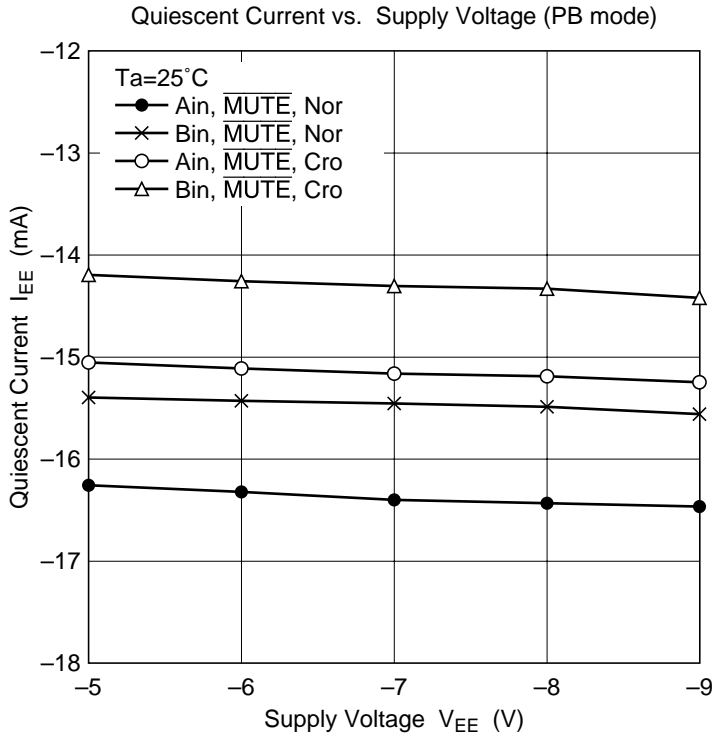

### RPOUT vs. Frequency (1) Ain mode

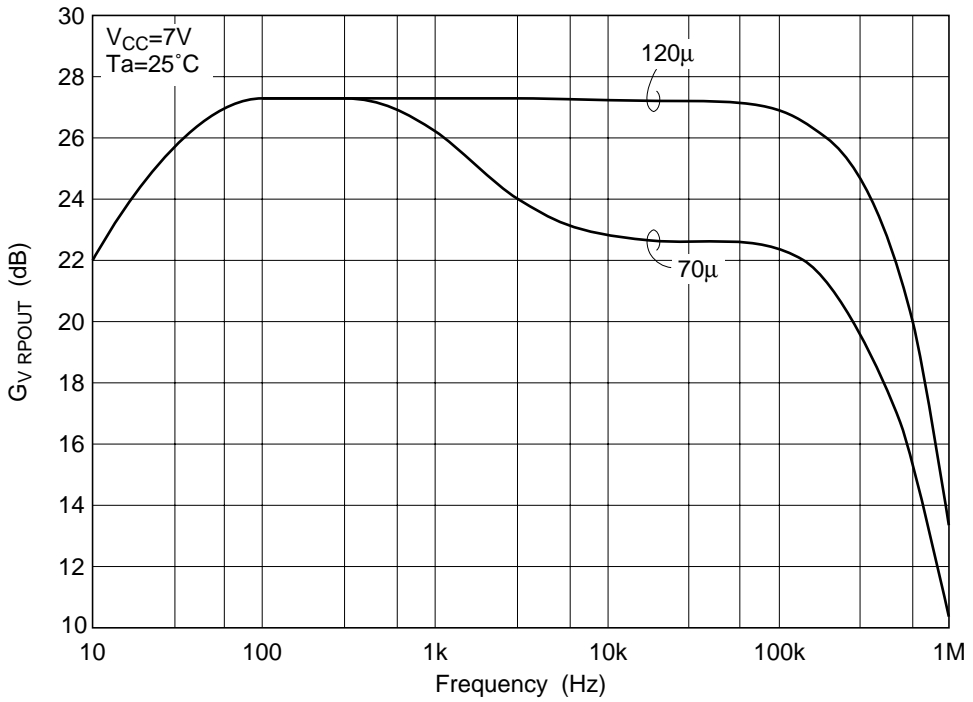

### RPOUT vs. Frequency (2) Rin mode

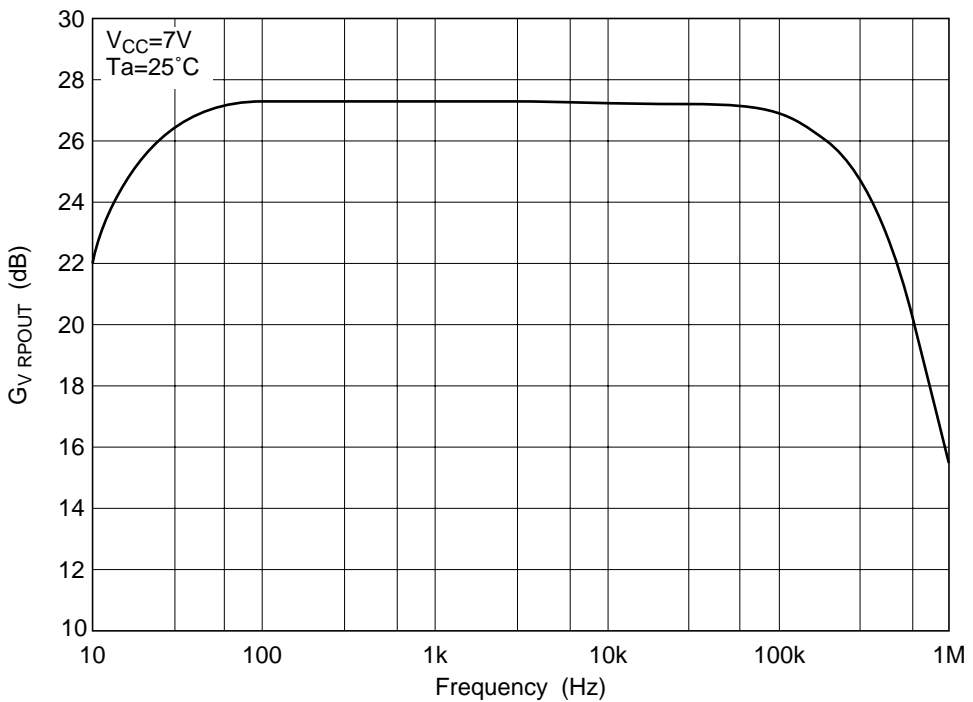

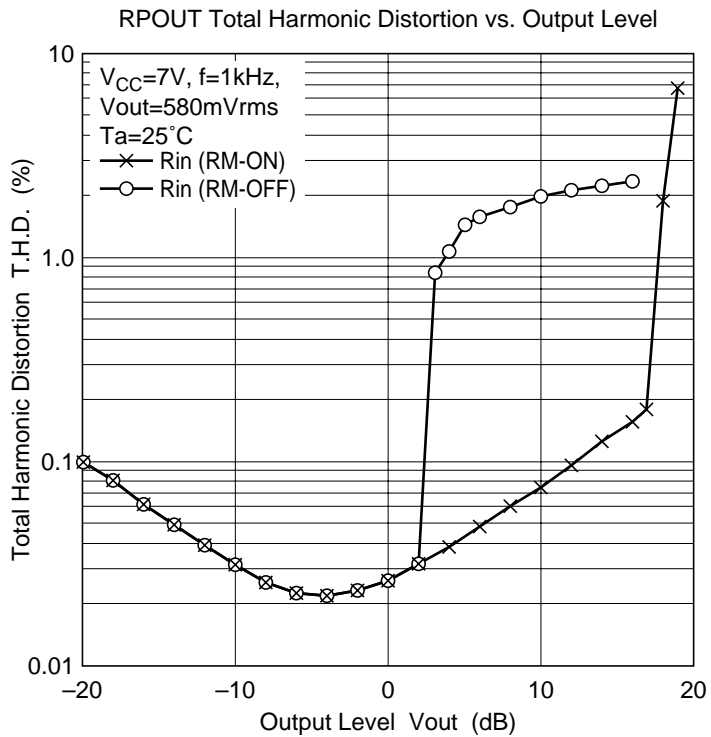
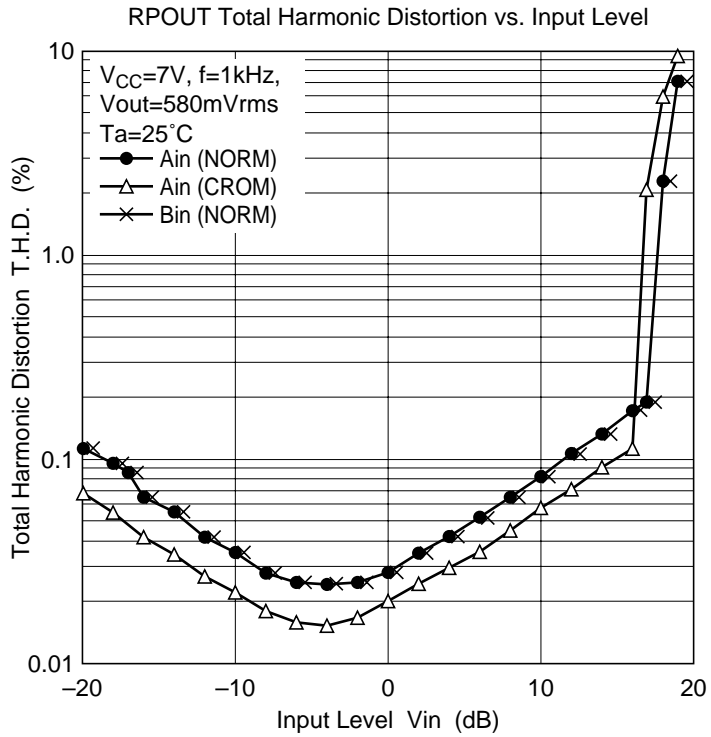

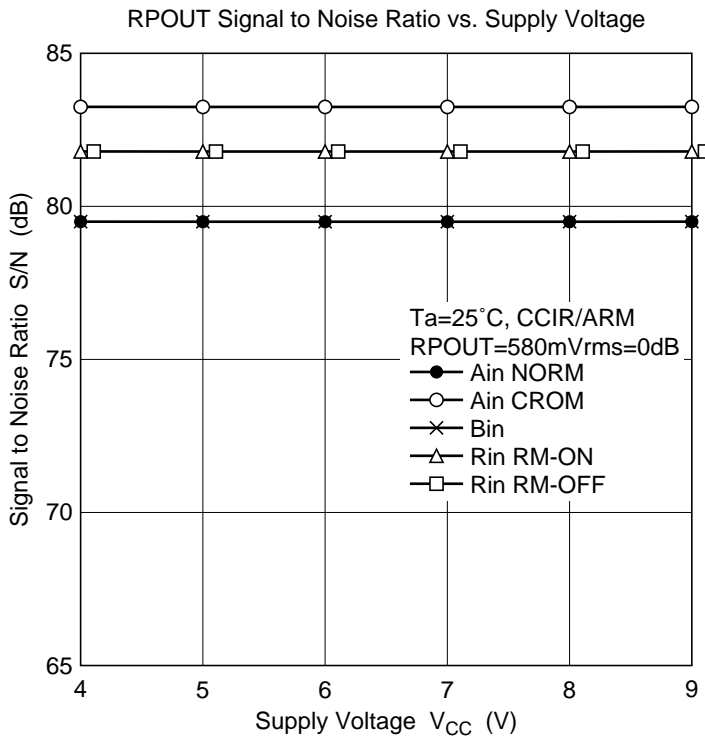
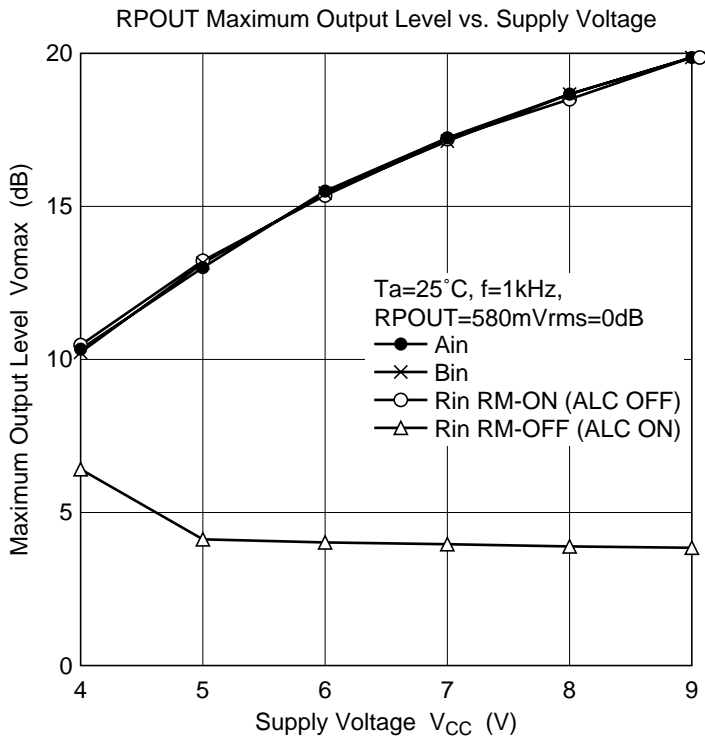

Line Amp. Crosstalk vs. Frequency

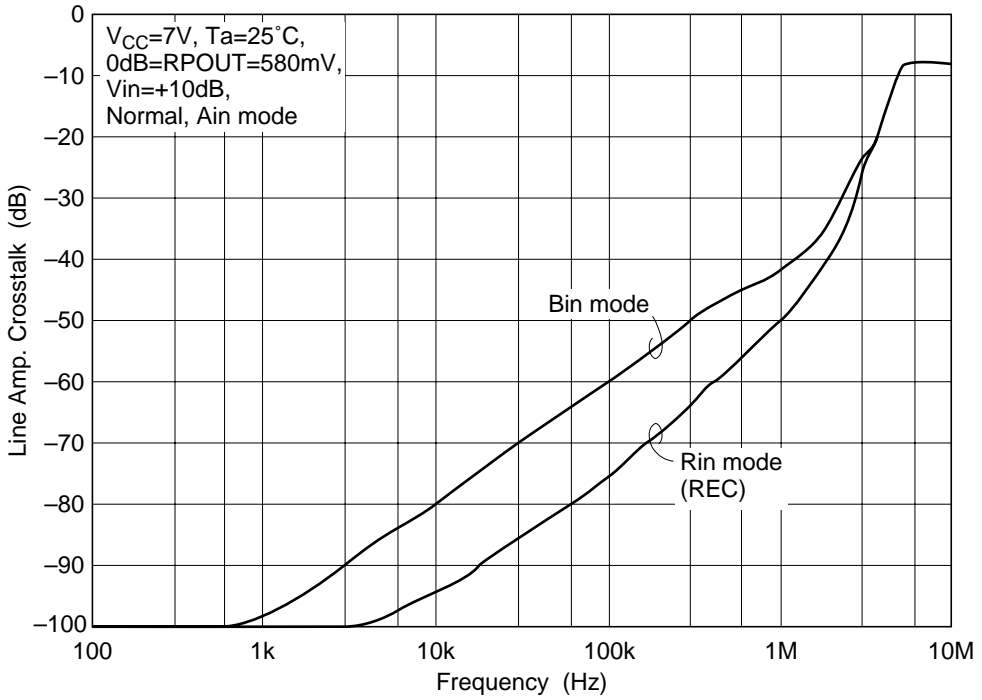

Line Amp. Channel Separation vs. Frequency

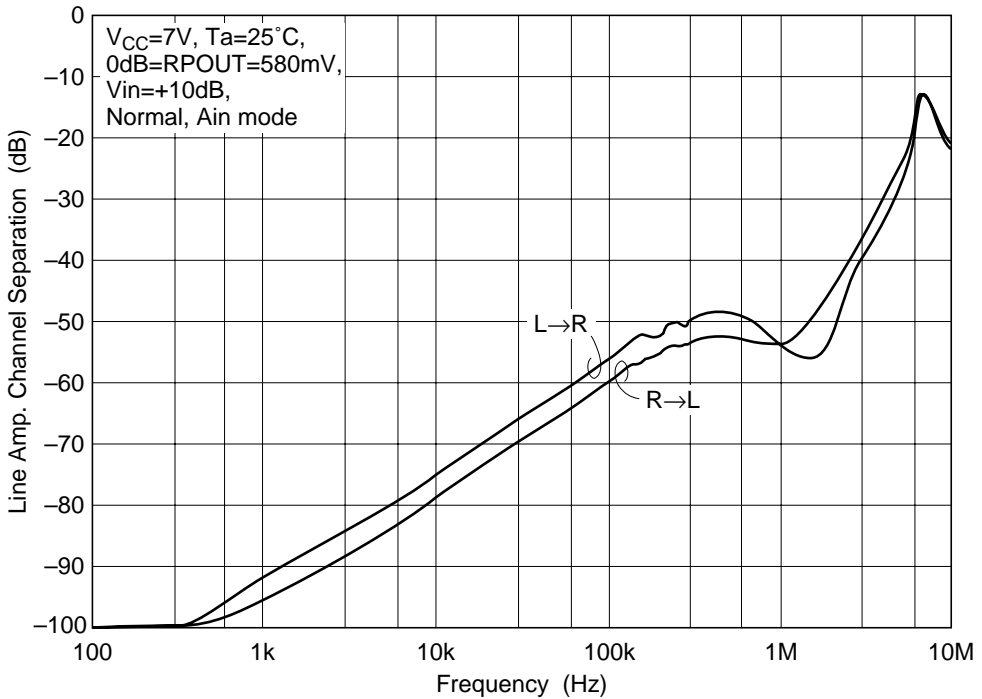

EQOUT vs. Frequency

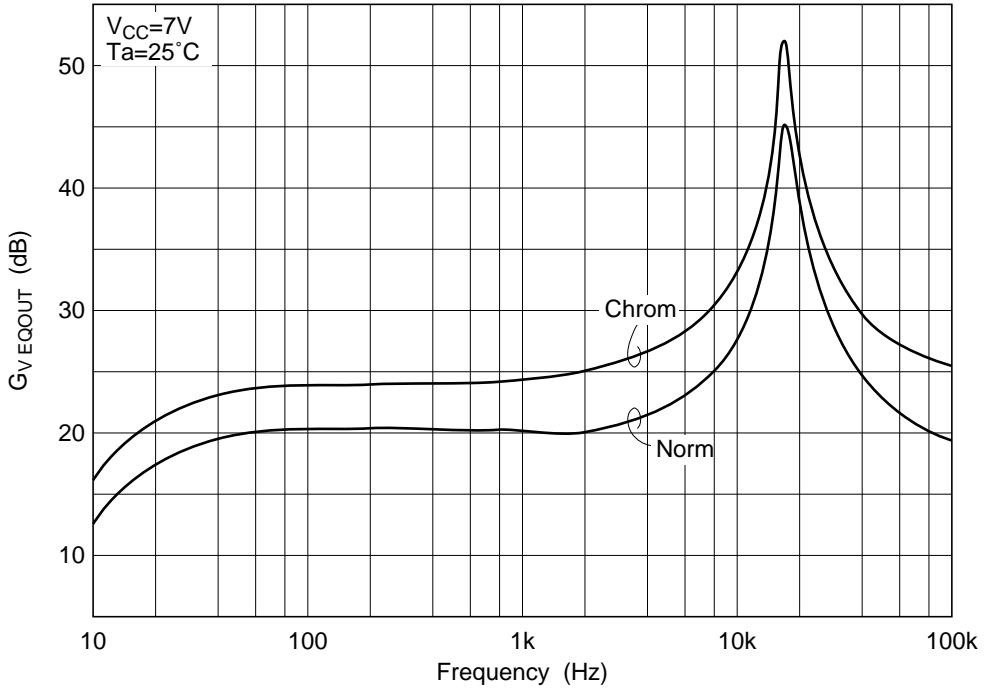

REC-EQ Total Harmonic Distortion (Normal) vs. Output Level

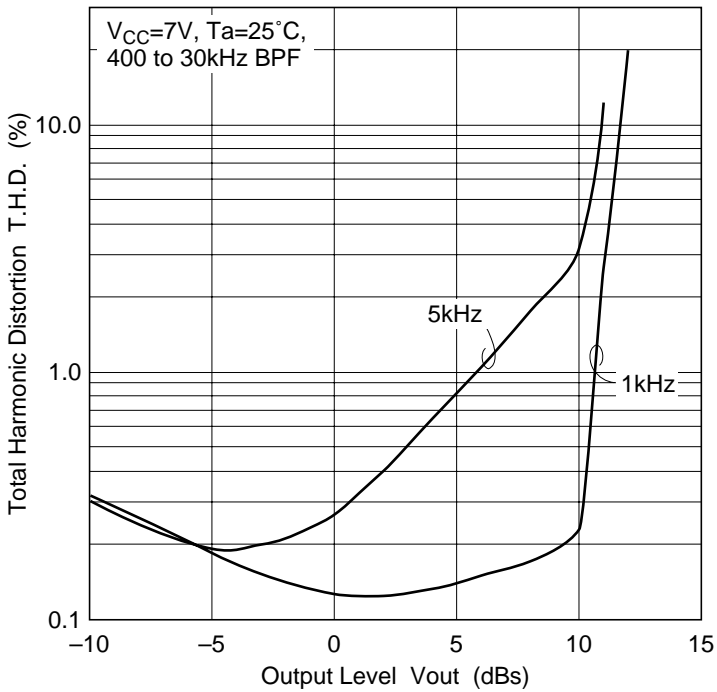



REC-EQ Total Harmonic Distortion (Chrom) vs. Output Level

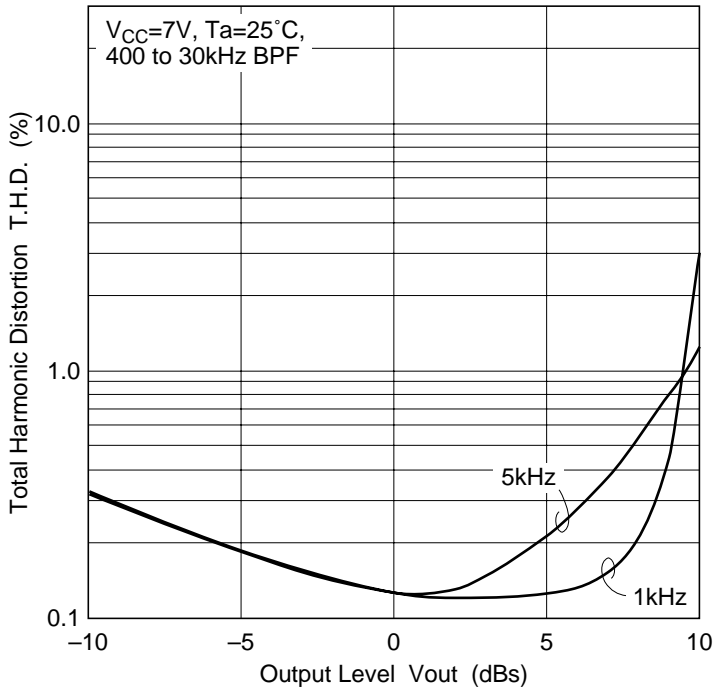

REC-EQ Maximum Output Level vs. Supply Voltage

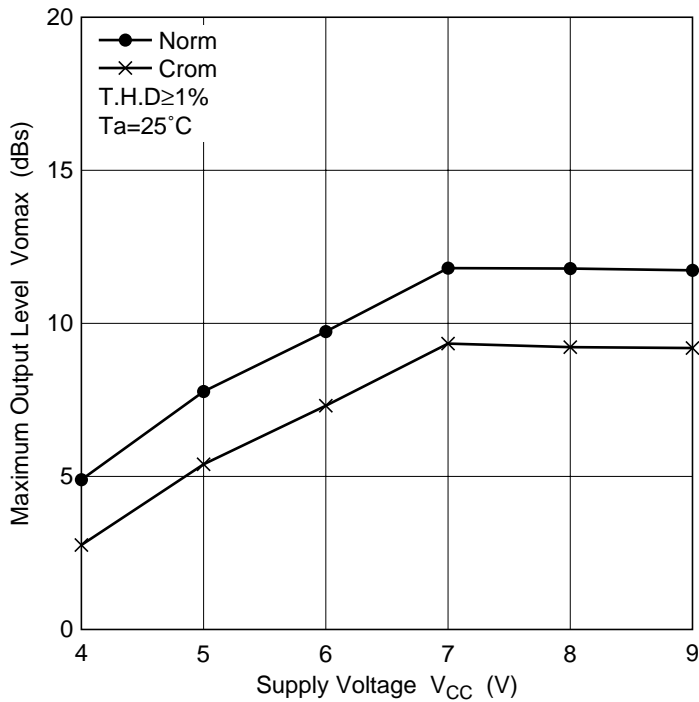

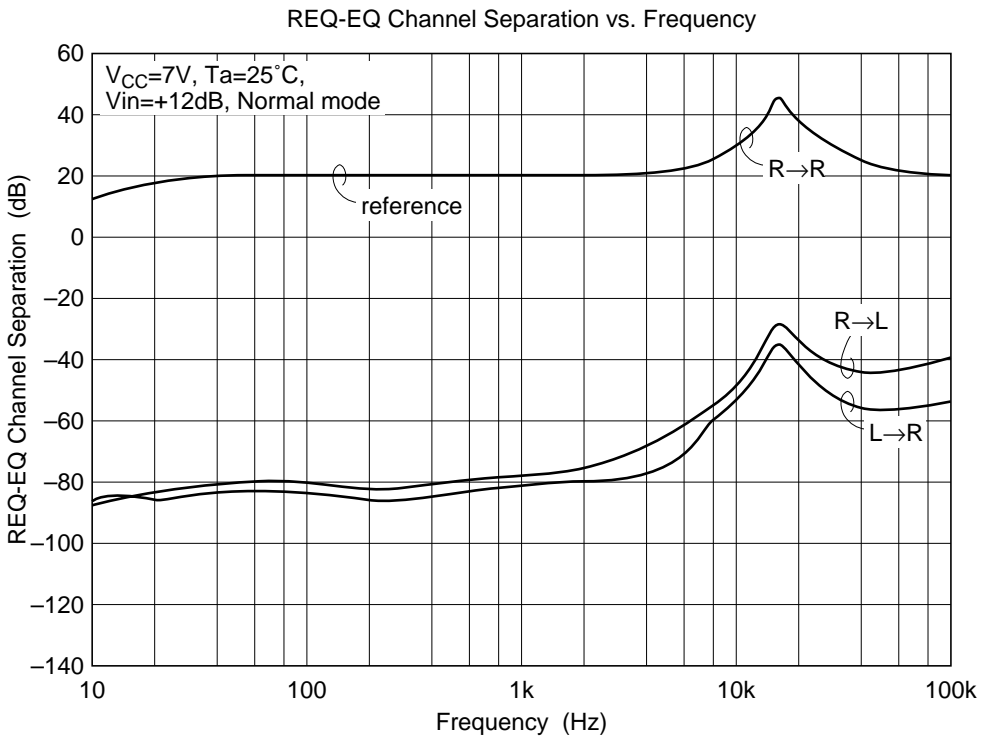
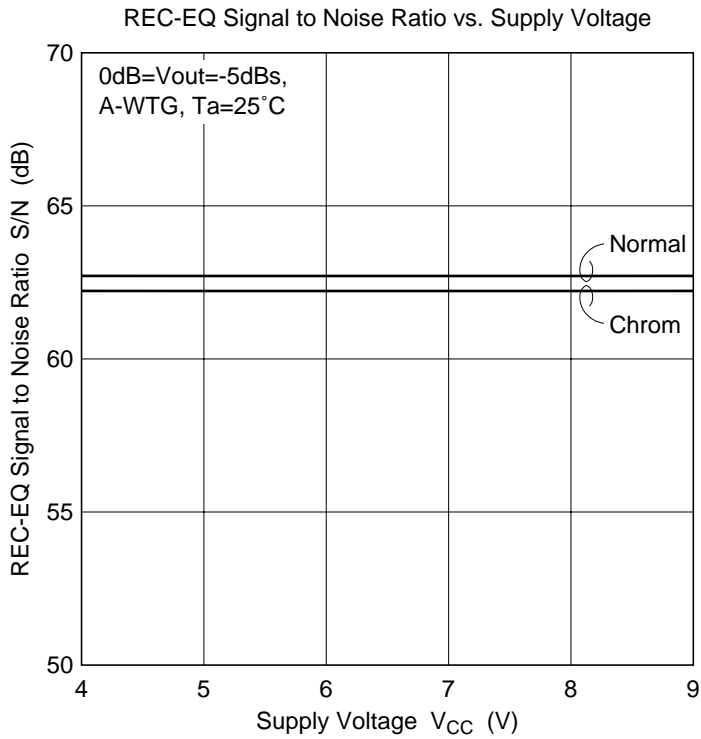

REQ-EQ Mute Attenuation vs. Frequency

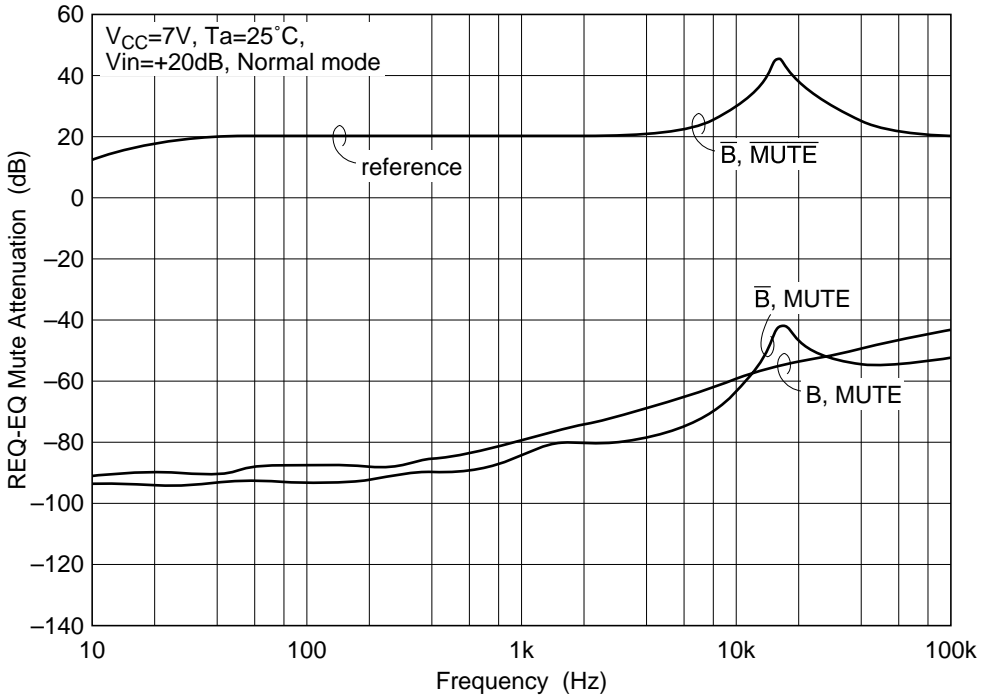

ALC Operate Level vs Input Level

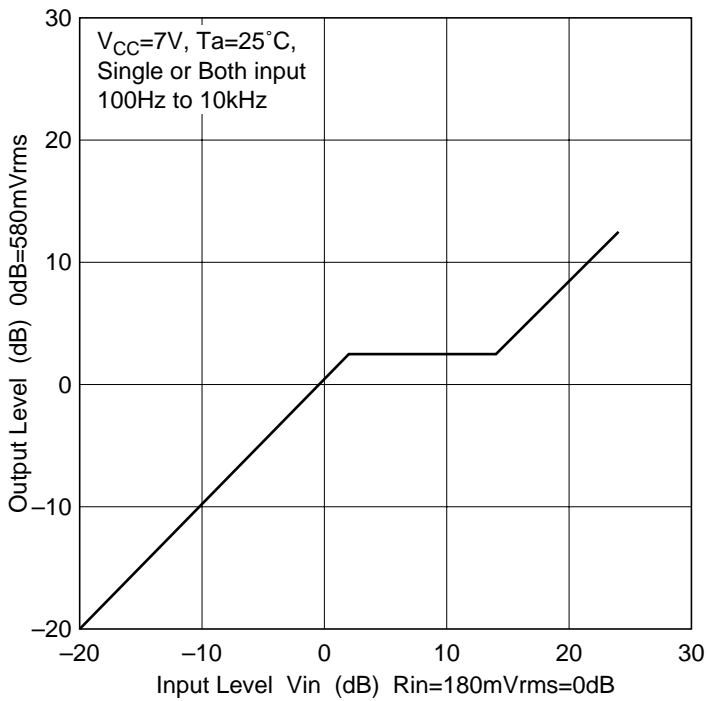

ALC Total Harmonic Distortion vs. Input Level

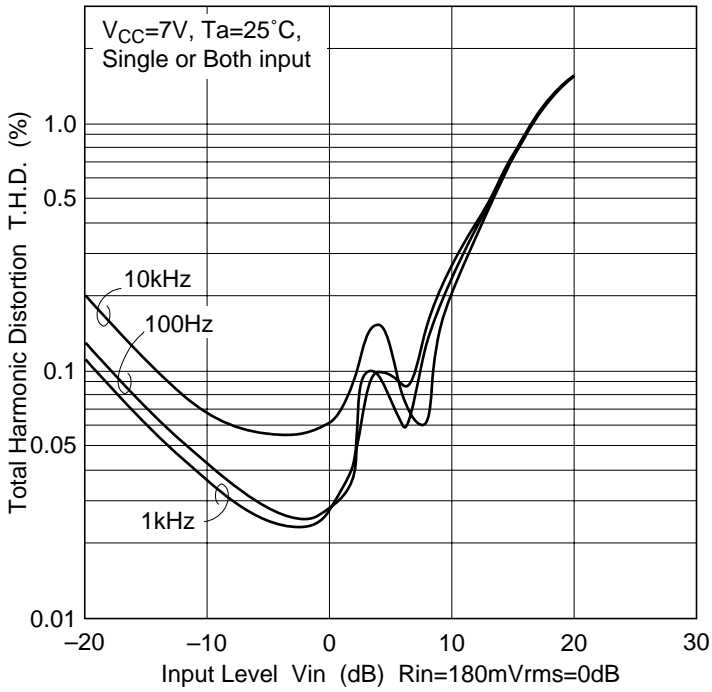

ALC Operate Level vs. Frequency

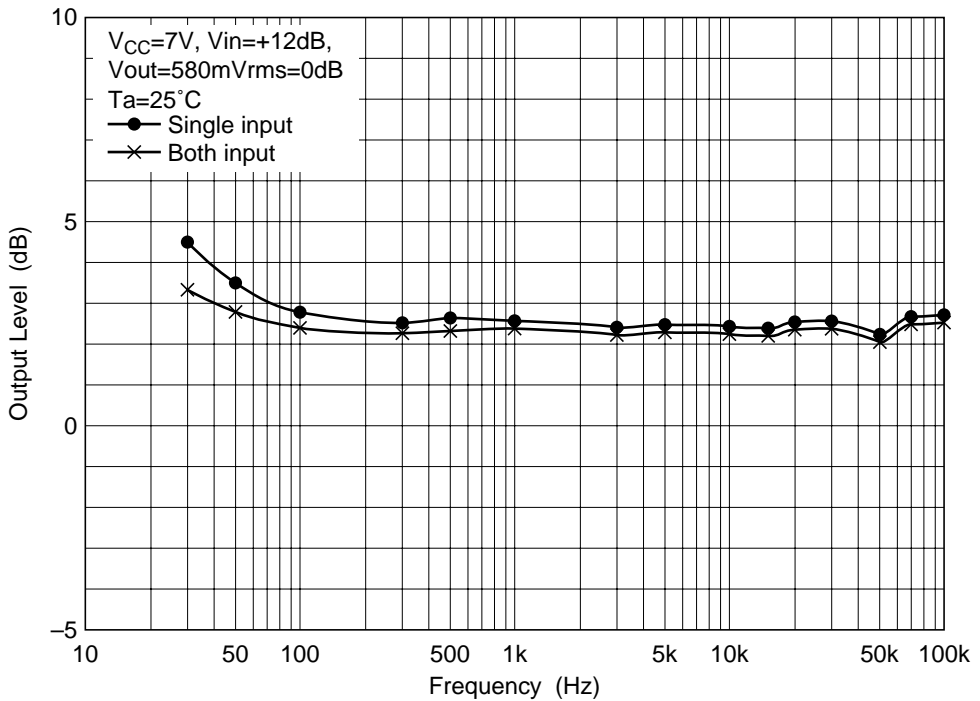

MS Sensing Level vs Frequency

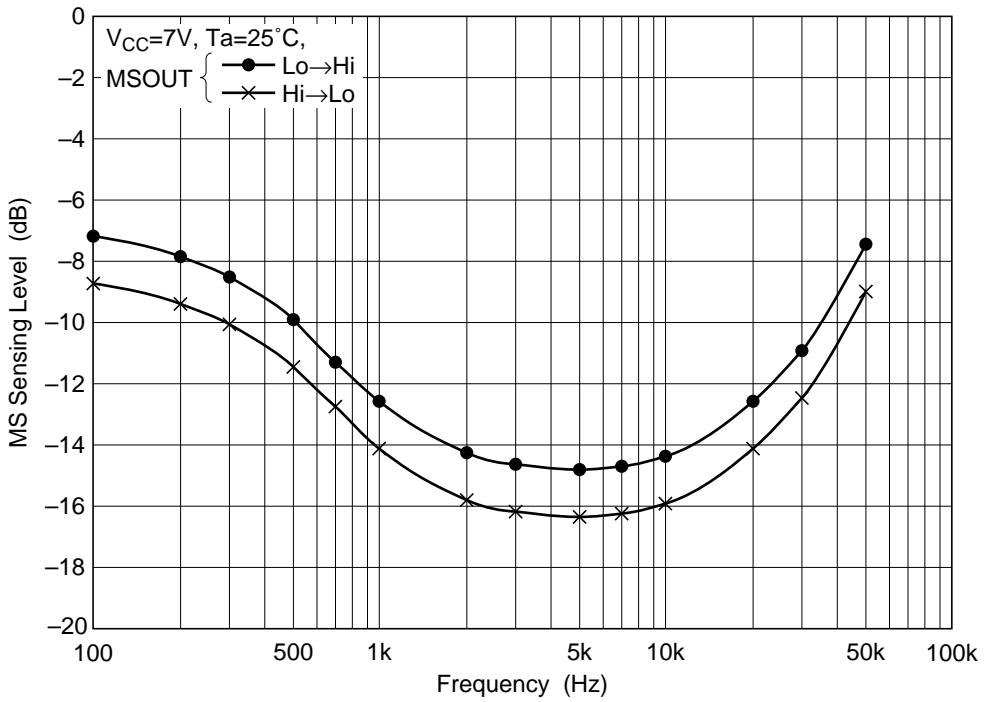

Signal Sensing Time vs. Capacitor

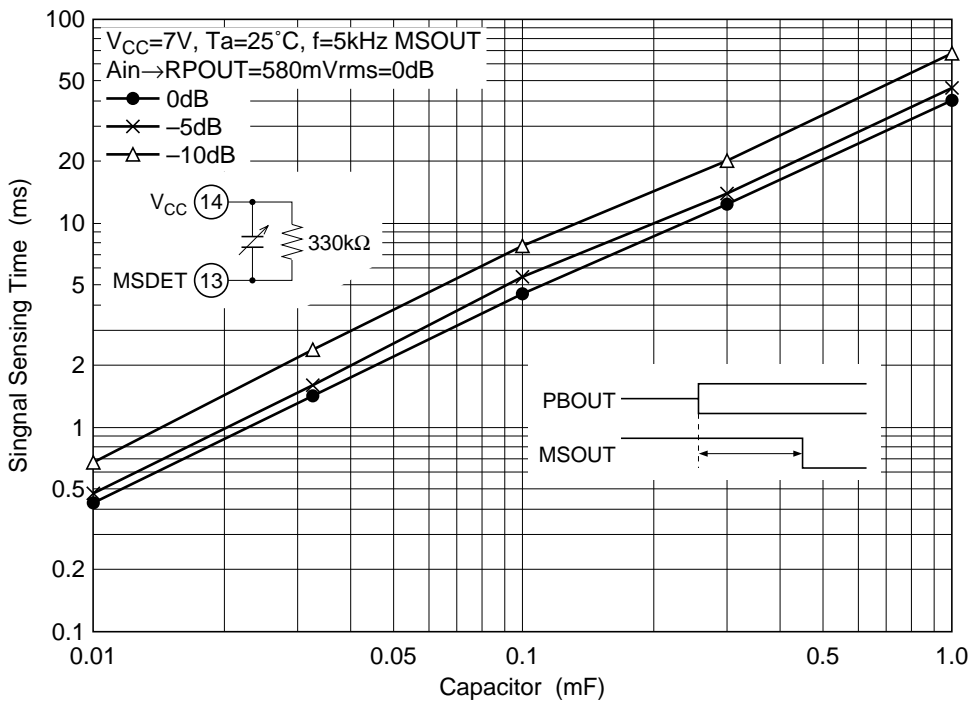

No Signal Sensing Time vs. Resistor

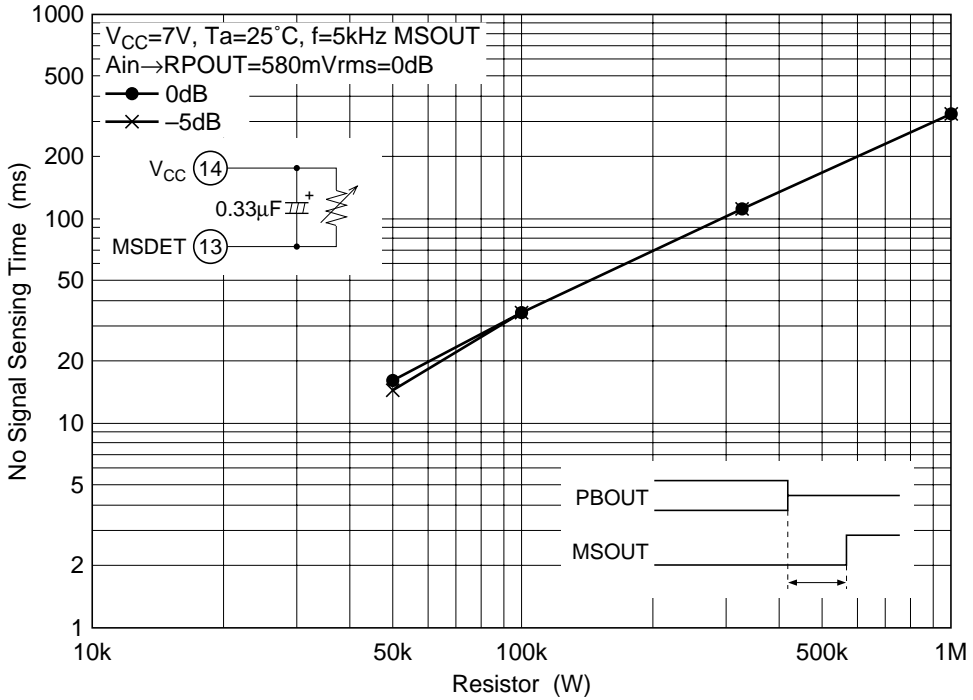

$V_{MSOUT}$  vs. Resistor  $R_L$

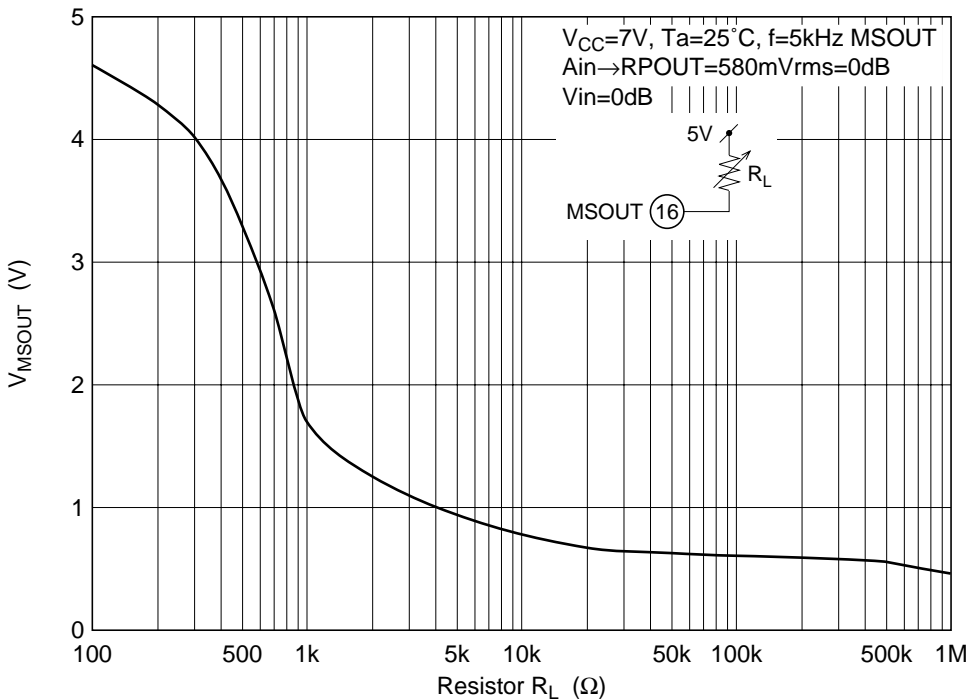

Package Dimensions

Unit: mm

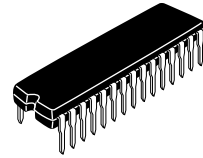
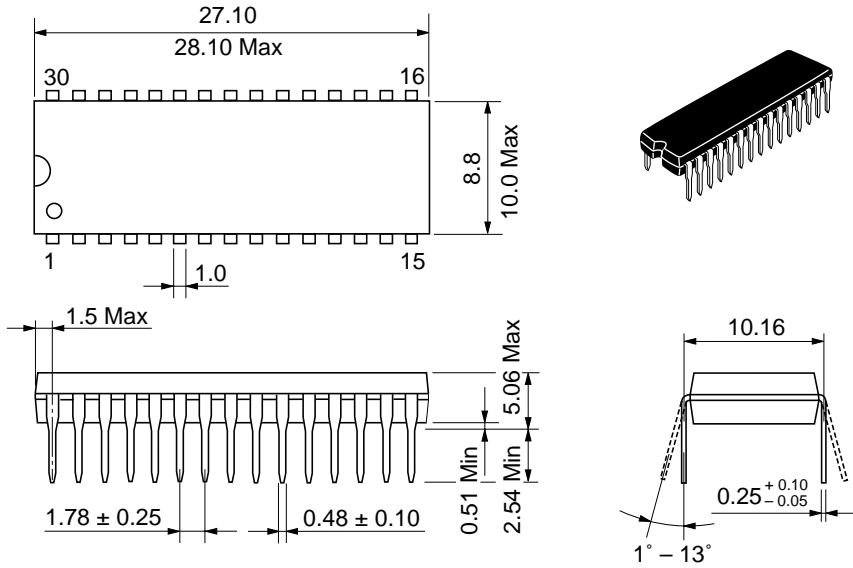

Hitachi Code	DP-30S
JEDEC	—
EIAJ	Conforms
Weight (reference value)	1.98 g

## Disclaimer

1. Hitachi neither warrants nor grants licenses of any rights of Hitachi's or any third party's patent, copyright, trademark, or other intellectual property rights for information contained in this document. Hitachi bears no responsibility for problems that may arise with third party's rights, including intellectual property rights, in connection with use of the information contained in this document.
2. Products and product specifications may be subject to change without notice. Confirm that you have received the latest product standards or specifications before final design, purchase or use.
3. Hitachi makes every attempt to ensure that its products are of high quality and reliability. However, contact Hitachi's sales office before using the product in an application that demands especially high quality and reliability or where its failure or malfunction may directly threaten human life or cause risk of bodily injury, such as aerospace, aeronautics, nuclear power, combustion control, transportation, traffic, safety equipment or medical equipment for life support.
4. Design your application so that the product is used within the ranges guaranteed by Hitachi particularly for maximum rating, operating supply voltage range, heat radiation characteristics, installation conditions and other characteristics. Hitachi bears no responsibility for failure or damage when used beyond the guaranteed ranges. Even within the guaranteed ranges, consider normally foreseeable failure rates or failure modes in semiconductor devices and employ systemic measures such as fail-safes, so that the equipment incorporating Hitachi product does not cause bodily injury, fire or other consequential damage due to operation of the Hitachi product.
5. This product is not designed to be radiation resistant.
6. No one is permitted to reproduce or duplicate, in any form, the whole or part of this document without written approval from Hitachi.
7. Contact Hitachi's sales office for any questions regarding this document or Hitachi semiconductor products.

## Sales Offices

# HITACHI

### Hitachi, Ltd.

Semiconductor & Integrated Circuits.  
Nippon Bldg., 2-6-2, Ohte-machi, Chiyoda-ku, Tokyo 100-0004, Japan  
Tel: Tokyo (03) 3270-2111 Fax: (03) 3270-5109

URL           NorthAmerica       : <http://semiconductor.hitachi.com/>  
                  Europe                : <http://www.hitachi-eu.com/hel/ecg>  
                  Asia                     : <http://sicapac.hitachi-asia.com>  
                  Japan                    : <http://www.hitachi.co.jp/Sicd/indx.htm>

### For further information write to:

Hitachi Semiconductor  
(America) Inc.  
179 East Tasman Drive,  
San Jose, CA 95134  
Tel: <1>(408) 433-1990  
Fax: <1>(408) 433-0223

Hitachi Europe GmbH  
Electronic Components Group  
Dornacher Straße 3  
D-85622 Feldkirchen, Munich  
Germany  
Tel: <49> (89) 9 9180-0  
Fax: <49> (89) 9 29 30 00

Hitachi Europe Ltd.  
Electronic Components Group.  
Whitebrook Park  
Lower Cookham Road  
Maidenhead  
Berkshire SL6 8YA, United Kingdom  
Tel: <44> (1628) 585000  
Fax: <44> (1628) 585160

Hitachi Asia Ltd.  
Hitachi Tower  
16 Collyer Quay #20-00,  
Singapore 049318  
Tel : <65>-538-6533/538-8577  
Fax : <65>-538-6933/538-3877  
URL : <http://www.hitachi.com.sg>

Hitachi Asia Ltd.  
(Taipei Branch Office)  
4/F, No. 167, Tun Hwa North Road,  
Hung-Kuo Building,  
Taipei (105), Taiwan  
Tel : <886>-(2)-2718-3666  
Fax : <886>-(2)-2718-8180  
Telex : 23222 HAS-TP  
URL : <http://www.hitachi.com.tw>

Hitachi Asia (Hong Kong) Ltd.  
Group III (Electronic Components)  
7/F., North Tower,  
World Finance Centre,  
Harbour City, Canton Road  
Tsim Sha Tsui, Kowloon,  
Hong Kong  
Tel : <852>-(2)-735-9218  
Fax : <852>-(2)-730-0281  
URL : <http://www.hitachi.com.hk>

Copyright © Hitachi, Ltd., 2000. All rights reserved. Printed in Japan.  
Colophon 2.0