

SWITCHMODE SERIES NPN POWER TRANSISTORS

... designed for use in high-voltage, high-speed, power switching in inductive circuit, they are particularly suited for 115 and 220 V switchmode applications such as switching regulator's, inverters, DC -DC conveter, Motor Controls, Solenoid drive and Deflection circuits.

FEATURES:

*Collector-Emitter Sustaining Voltage-

$$V_{CE(sus)} = 400 \text{ V and } 300 \text{ V}$$

* Collector-Emitter Saturation Voltage -

$$V_{CE(sat)} = 3.0 \text{ V (Max.) @ } I_C = 8.0 \text{ A, } I_B = 2.0 \text{ A}$$

* Switching Time - $t_f = 0.7 \text{ us (Max.) @ } I_C = 5.0 \text{ A}$

* SOA and Switching Application Information.

NPN
MJE13006
MJE13007

8 AMPERE
POWER
TRANSISTORS
300-400 VOLTS
80 WATTS

MAXIMUM RATINGS

| Characteristic | Symbol | MJE13006 | MJE13007 | Unit |
|---|----------------|-------------|----------|------------|
| Collector-Emitter Voltage | V_{CEO} | 300 | 400 | V |
| Collector-Emitter Voltage | V_{CEV} | 600 | 700 | V |
| Emitter-Base Voltage | V_{EBO} | 9 | | V |
| Collector Current - Continuous | I_C | 8 | | A |
| Collector Current - Peak | I_{CM} | 16 | | A |
| Base current | I_B | 4 | | A |
| Total Power Dissipation @ $T_C = 25^\circ\text{C}$ Derate above 25°C | P_D | 80 | 640 | W mW/°C |
| Operating and Storage Junction Temperature Range | T_J, T_{STG} | -65 to +150 | | °C |

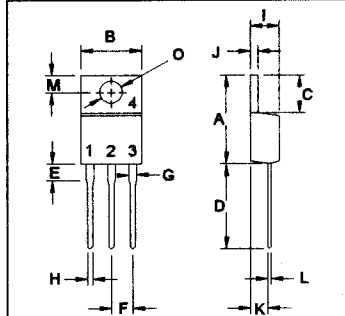
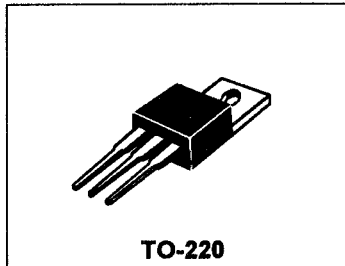

PIN 1.BASE
2.COLLECTOR
3.EMITTER
4.COLLECTOR(CASE)

THERMAL CHARACTERISTICS

| Characteristic | Symbol | Max | Unit |
|-------------------------------------|-----------------|------|------|
| Thermal Resistance Junction to Case | $R_{\theta jc}$ | 1.56 | °C/W |

| DIM | MILLIMETERS | |
|-----|-------------|-------|
| | MIN | MAX |
| A | 14.68 | 15.31 |
| B | 9.78 | 10.42 |
| C | 5.01 | 6.52 |
| D | 13.06 | 14.62 |
| E | 3.57 | 4.07 |
| F | 2.42 | 3.66 |
| G | 1.12 | 1.36 |
| H | 0.72 | 0.96 |
| I | 4.22 | 4.98 |
| J | 1.14 | 1.38 |
| K | 2.20 | 2.97 |
| L | 0.33 | 0.55 |
| M | 2.48 | 2.98 |
| O | 3.70 | 3.90 |

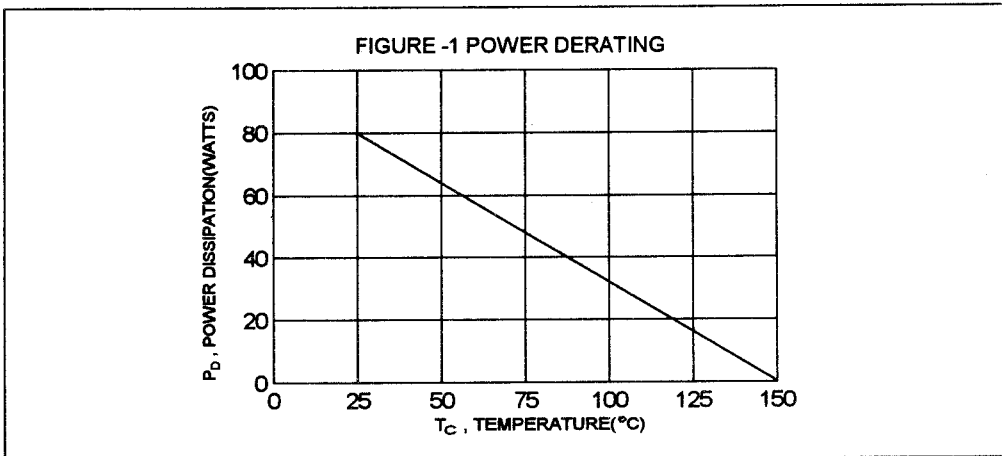

ELECTRICAL CHARACTERISTICS ($T_c = 25^\circ\text{C}$ unless otherwise noted)

| Characteristic | Symbol | Min | Max | Unit |
|----------------|--------|-----|-----|------|
|----------------|--------|-----|-----|------|

OFF CHARACTERISTICS

| | | | | |
|---|----------------|------------|------------|----|
| Collector-Emitter Sustaining Voltage ($I_C = 10\text{ mA}, I_B = 0$) MJE13006 MJE13007 | $V_{CEO(sus)}$ | 300 400 | | V |
| Collector Cutoff Current ($V_{CEV} = \text{Rated Value}, V_{BE(off)} = 1.5\text{ V}$) ($V_{CEV} = \text{Rated Value}, V_{BE(off)} = 1.5\text{ V}, T_c = 100^\circ\text{C}$) | I_{CEV} | | 1.0 5.0 | mA |
| Emitter Cutoff Current ($V_{EB} = 9.0\text{ V}, I_C = 0$) | I_{EBO} | | 1.0 | mA |

ON CHARACTERISTICS (1)

| | | | | |
|---|---------------|------------|-------------------|---|
| DC Current Gain ($I_C = 2.0\text{ A}, V_{CE} = 5.0\text{ V}$) ($I_C = 5.0\text{ A}, V_{CE} = 5.0\text{ V}$) | hFE | 8.0 5.0 | 60 30 | |
| Collector-Emitter Saturation Voltage ($I_C = 2.0\text{ A}, I_B = 400\text{ mA}$) ($I_C = 5.0\text{ A}, I_B = 1.0\text{ A}$) ($I_C = 8.0\text{ A}, I_B = 2.0\text{ A}$) | $V_{CE(sat)}$ | | 1.0 2.0 3.0 | V |
| Base-Emitter Saturation Voltage ($I_C = 2.0\text{ A}, I_B = 400\text{ mA}$) ($I_C = 5.0\text{ A}, I_B = 1.0\text{ A}$) | $V_{BE(sat)}$ | | 1.2 1.6 | V |

DYNAMIC CHARACTERISTICS

| | | | | |
|---|----------|----------|--|-----|
| Current Gain - Bandwidth Product ($I_C = 500\text{ mA}, V_{CE} = 10\text{ V}, f = 1.0\text{ MHz}$) | f_T | 4.0 | | MHz |
| Output Capacitance ($V_{CB} = 10\text{ V}, I_E = 0, f = 0.1\text{ MHz}$) | C_{ob} | 110(typ) | | pF |

SWITCHING CHARACTERISTICS

| | | | | |
|--------------|---|-------|-----|----|
| Delay Time | $V_{CC} = 125\text{ V}, I_C = 5.0\text{ A}$ $I_{B1} = -I_{B2} = 1.0\text{ A},$ $t_p = 25\text{ us}, \text{Duty Cycle} \leq 1.0\%$ | t_d | 0.1 | us |
| Rise Time | | t_r | 1.5 | us |
| Storage Time | | t_s | 3.0 | us |
| Fall Time | | t_f | 0.7 | us |

(1) Pulse Test: Pulse Width = 300 us, Duty Cycle $\leq 2.0\%$

DC CURRENT GAIN

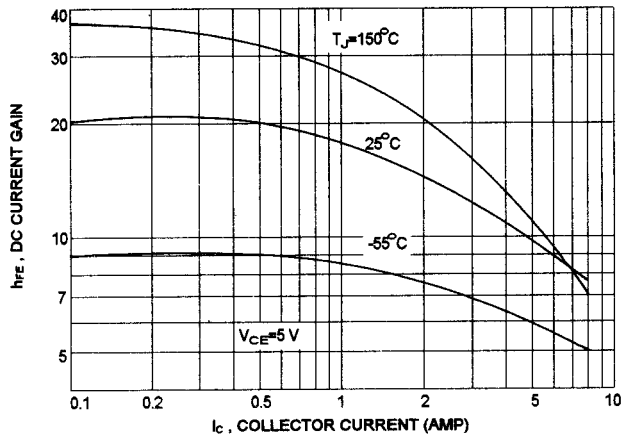

COLLECTOR SATURATION REGION

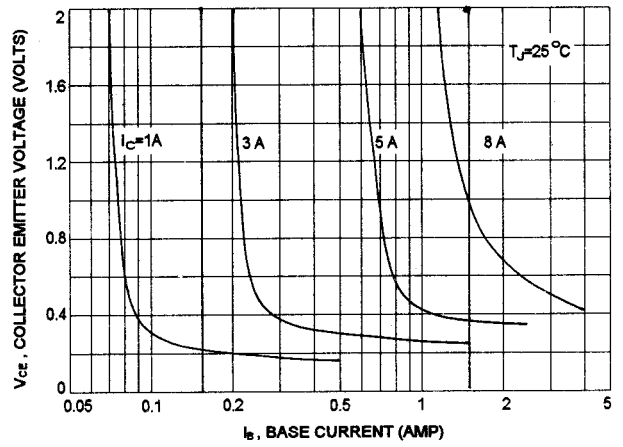

BASE-EMITTER SATURATION VOLTAGE

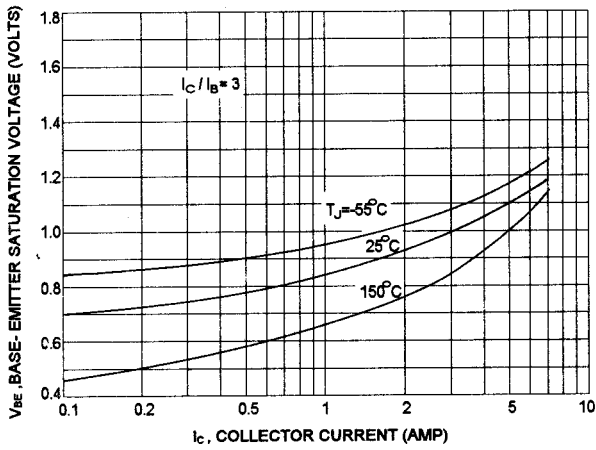

COLLECTOR-EMITTER SATURATION VOLTAGE

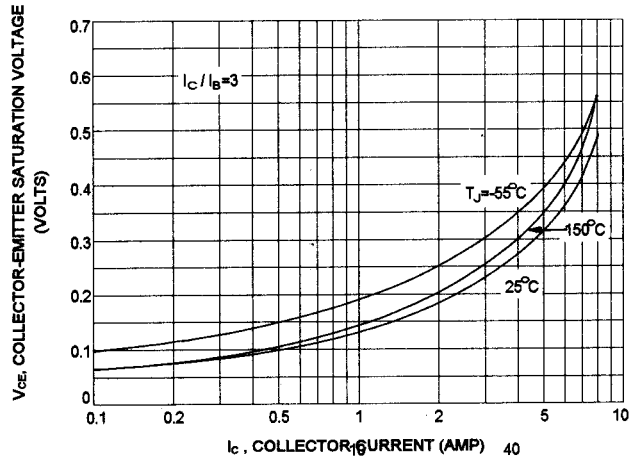

COLLECTOR CUT-OFF REGION

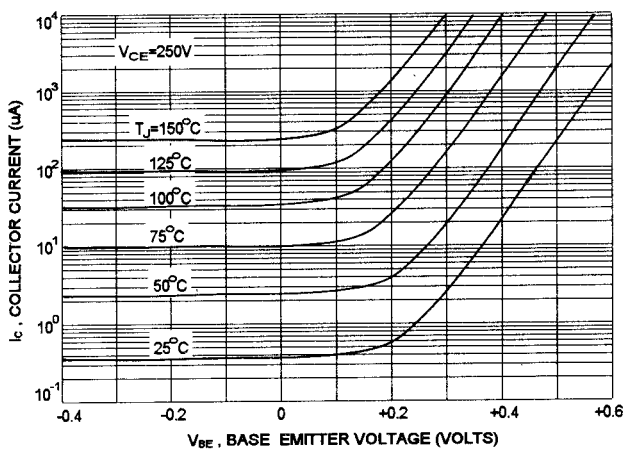

CAPACITANCE

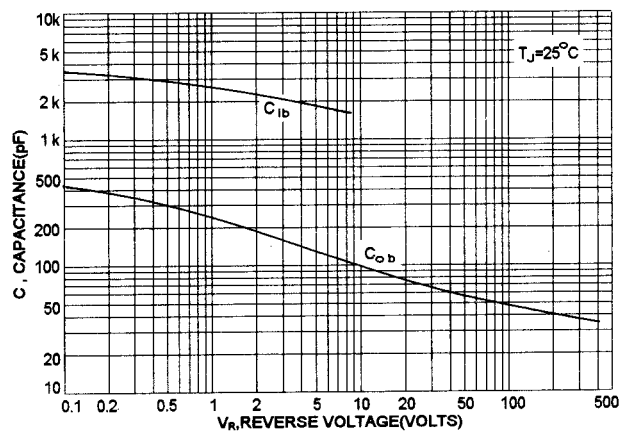

TURN-ON TIME

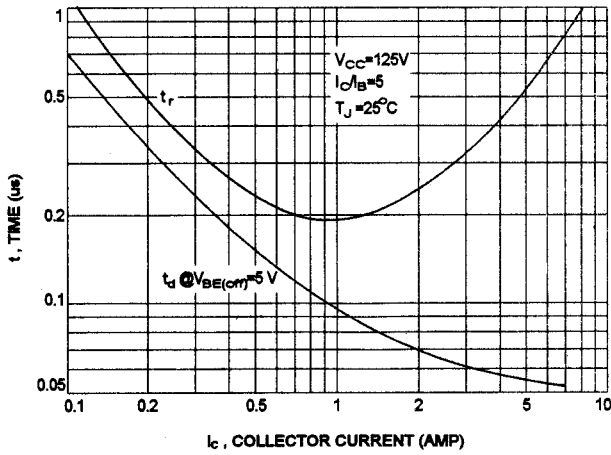

TURN-OFF TIME

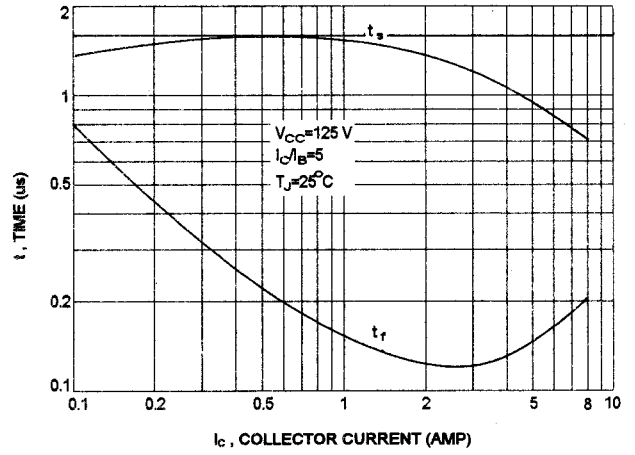

ACTIVE REGION SAFE OPERATING AREA

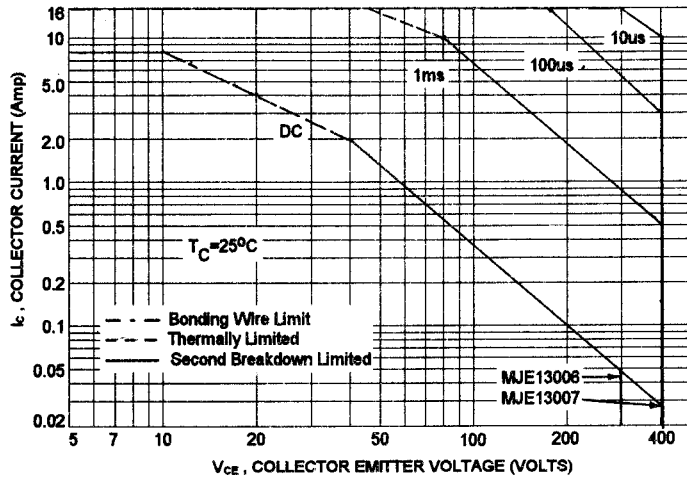

REVERSE BIAS SWITCHING SAFE OPERATING AREA

