

FEATURES

- Keeps track of hundredths of seconds, seconds, minutes, hours, days, date of the month, months, and years; valid leap year compensation up to 2100
- Watchdog timer restarts an out-of-control processor
- Alarm function schedules real time-related activities
- Embedded lithium energy cell maintains time, watchdog, user RAM, and alarm information
- Programmable interrupts and square wave outputs maintain 28-pin JEDEC footprint
- All registers are individually addressable via the address and data bus
- Accuracy is better than ± 1 minute/month at 25°C
- Greater than 10 years of timekeeping in the absence of V_{CC}
- 50 bytes of user NV RAM

PIN ASSIGNMENT

\overline{INTA}	1	28	V_{CC}
NC	2	27	\overline{WE}
NC	3	26	$\overline{INTB(INTB)}$
NC	4	25	NC
A5	5	24	NC
A4	6	23	SQW
A3	7	22	\overline{OE}
A2	8	21	NC
A1	9	20	\overline{CE}
A0	10	19	DQ7
DQ0	11	18	DQ6
DQ1	12	17	DQ5
DQ2	13	16	DQ4
GND	14	15	DQ3

28-Pin Encapsulated Package
(720-Mil Flush)

PIN DESCRIPTION

\overline{INTA}	- Interrupt Output A (open drain)
$\overline{INTB (INTB)}$	- Interrupt Output B (open drain)
A0-A5	- Address Inputs
DQ0-DQ7	- Data Input/Output
\overline{CE}	- Chip Enable
\overline{OE}	- Output Enable
\overline{WE}	- Write Enable
V_{CC}	- +5 Volts
GND	- Ground
NC	- No Connection
SQW	- Square Wave Output

DESCRIPTION

The DS1286 Watchdog Timekeeper is a self-contained real time clock, alarm, watchdog timer, and interval timer in a 28-pin JEDEC DIP package. The DS1286 contains an embedded lithium energy source and a quartz crystal which eliminates the need for any external circuitry. Data contained within 64 eight-bit registers can be read or written in the same manner as byte-wide static RAM. Data is maintained in the Watchdog Timekeeper by intelligent control circuitry which detects the status of V_{CC} and write protects memory when V_{CC} is out of tolerance. The lithium energy source can maintain data and real time for over 10 years in the absence of V_{CC} . Watchdog Timekeeper information includes hundredths of seconds, seconds, minutes, hours, day, date, month, and year. The date at the end of the month is automatically

adjusted for months with less than 31 days, including correction for leap year. The Watchdog Timekeeper operates in either 24-hour or 12-hour format with an AM/PM indicator. The watchdog timer provides alarm windows and interval timing between 0.01 seconds and 99.99 seconds. The real time alarm provides for preset times of up to one week.

OPERATION - READ REGISTERS

The DS1286 executes a read cycle whenever \overline{WE} (Write Enable) is inactive (High) and \overline{CE} (Chip Enable) and \overline{OE} (Output Enable) are active (Low). The unique address specified by the six address inputs (A0-A5) defines which of the 64 registers is to be accessed. Valid data will be available to the eight data output drivers within t_{ACC} (Access Time) after the last address input signal is stable, providing that \overline{CE} and \overline{OE} access times are also satisfied. If \overline{OE} and \overline{CE} access times are not satisfied, then data access must be measured from the latter occurring signal (\overline{CE} or \overline{OE}) and the limiting parameter is either t_{CO} for \overline{CE} or t_{OE} for \overline{OE} rather than address access.

OPERATION - WRITE REGISTERS

The DS1286 is in the write mode whenever the \overline{WE} (Write Enable) and \overline{CE} (Chip Enable) signals are in the active (Low) state after the address inputs are stable. The latter occurring falling edge of \overline{CE} or \overline{WE} will determine the start of the write cycle. The write cycle is terminated by the earlier rising edge of \overline{CE} or \overline{WE} . All address inputs must be kept valid throughout the write cycle. \overline{WE} must return to the high state for a minimum recovery state (t_{WR}) before another cycle can be initiated. Data must be valid on the data bus with sufficient Data Set Up (t_{DS}) and Data Hold Time (t_{DH}) with respect to the earlier rising edge of \overline{CE} or \overline{WE} . The \overline{OE} control signal should be kept inactive (High) during write cycles to avoid bus contention. However, if the output bus has been enabled (\overline{CE} and \overline{OE} active), then \overline{WE} will disable the outputs in t_{ODW} from its falling edge.

DATA RETENTION

The Watchdog Timekeeper provides full functional capability when V_{CC} is greater than 4.5 volts and write protects the register contents at 4.25 volts typical. Data is maintained in the absence of V_{CC} without any additional support circuitry. The DS1286 constantly monitors V_{CC} . Should the supply voltage decay, the Watchdog Timekeeper will automatically write protect itself and all inputs to the registers become "Don't Care." Both \overline{INTA} and \overline{INTB} (INTB) are open drain outputs. The two interrupts and the internal clock continue to run regardless of the level of V_{CC} . However, it is important to insure that the pull-up resistors used with the interrupt pins are never pulled up to a value which is greater than $V_{CC} + 0.3V$. As V_{CC} falls below approximately 3.0 volts, a power switching circuit turns on the lithium energy source to maintain the clock, and timer data functionality. It is also required to insure that during this time (battery backup mode), the voltage present at \overline{INTA} and \overline{INTB} (INTB) never exceeds 3.0V. At all times the current on each should not exceed +2.1 mA or -1.0 mA. However, if the active high mode is selected for \overline{INTB} (INTB), this pin will only go high in the presence of V_{CC} . During power-up, when V_{CC} rises above approximately 3.0 volts, the power switching circuit connects external V_{CC} and disconnects the internal lithium energy source. Normal operation can resume after V_{CC} exceeds 4.5 volts for a period of 150 ms.

WATCHDOG TIMEKEEPER REGISTERS

The Watchdog Timekeeper has 64 registers which are 8 bits wide that contain all of the Timekeeping, Alarm, Watchdog, Control, and Data information. The Clock, Calendar, Alarm, and Watchdog registers are memory locations which contain external (user-accessible) and internal copies of the data. The external copies are independent of internal functions except that they are updated periodically by the simultaneous transfer of the incremented internal copy (see Figure 1). The Command Register bits are affected by both internal and external functions. This register will be discussed later. The 50 bytes of RAM registers can only be accessed from the external address and data bus. Registers 0, 1, 2, 4, 6, 8, 9, and A contain time of day and date information (see Figure 2). Time of Day information is stored in BCD. Registers 3, 5, and 7 contain the Time of Day Alarm information. Time of Day Alarm information is stored in BCD. Register B is the Command Register and information in this register is binary. Registers C and D are the Watchdog Alarm registers and information which is stored in these two registers is in BCD. Registers E through 3F are user bytes and can be used to contain data at the user's discretion.

BLOCK DIAGRAM Figure 1

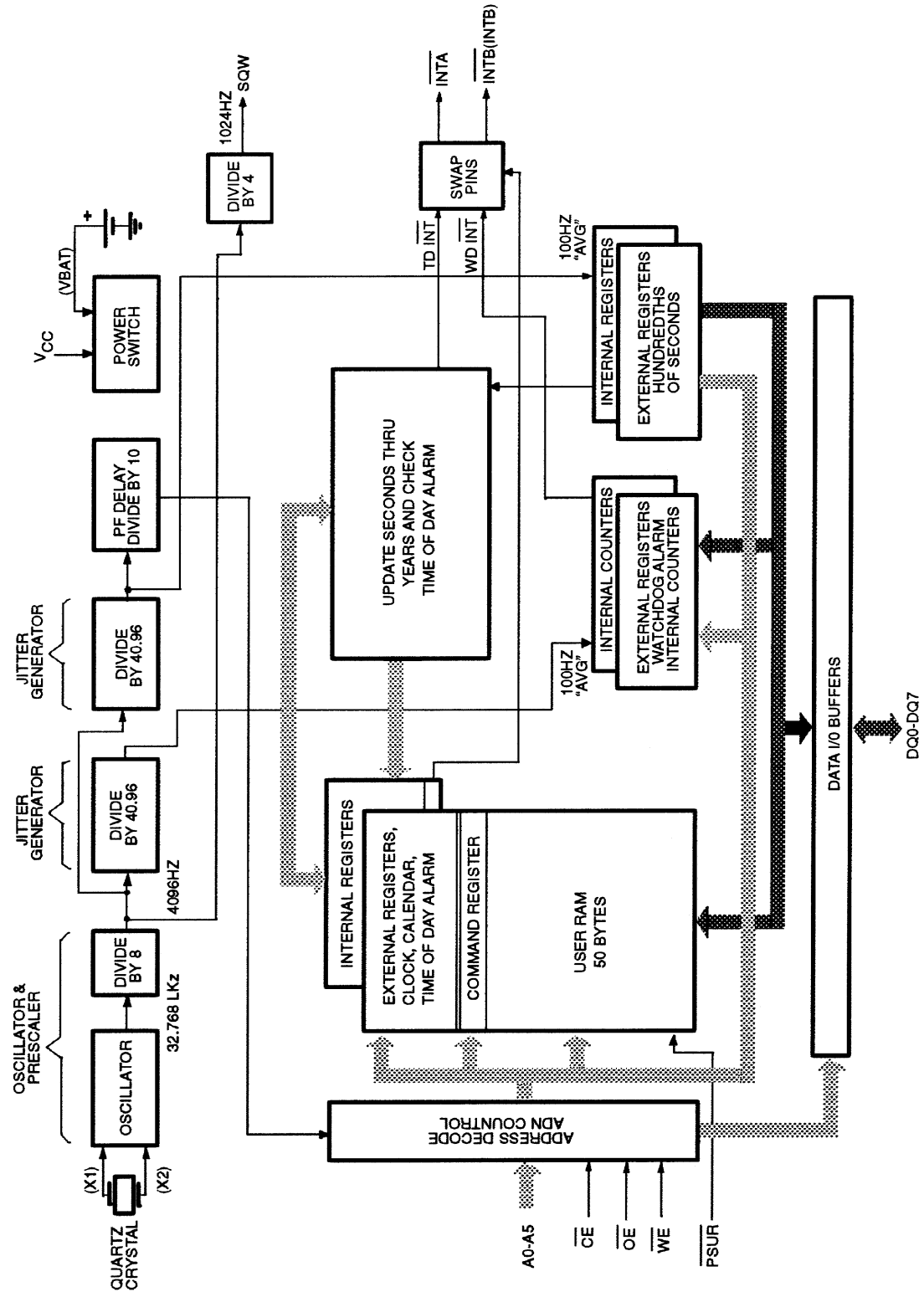

DS1286 WATCHDOG TIMEKEEPER REGISTERS Figure 2

ADDRESS	BIT 7						BIT 0	RANGE	
0	0.1 SECONDS				0.01 SECONDS				00-99
1	0	10 SECONDS			SECONDS				00-59
2	0	10 MINUTES			MINUTES				00-59
3	M	10MIN ALARM			MIN ALARM				00-59
4	0	12/24	10 A/P	10 HR		HOURS			01-12+A/P 00-23
5	M	12/24	10 A/P	10 HR		HR ALARM			01-12+A/P 00-23
6	0	0	0	0	0	DAYS			01-07
7	M	0	0	0	0	DAY ALARM			01-07
8	0	0	10 DATE		DATE				01-31
9	EOSC	ESQW	0	10MO		MONTHS			01-12
A	10 YEARS				YEARS				00-99
B	TE	IPSW	IBH LO	PU LVL	WAM	TDM	WAF	TDF	
C	0.1 SECONDS				0.01 SECONDS				00-99
D	10 SECONDS				SECONDS				00-99
E									
3F									

CLOCK, CALENDAR,
TIME OF DAY ALARM
REGISTERS

COMMAND
REGISTERS

WATCHDOG
ALARM
REGISTERS

(RETRIGGERABLE/
REPETITIVE COUNTDOWN
ALARM)

USER
REGISTERS

TIME OF DAY REGISTERS

Registers 0, 1, 2, 4, 6, 8, 9, and A contain Time of Day data in BCD. Ten bits within these eight registers are not used and will always read 0 regardless of how they are written. Bits 6 and 7 in the Months Register (9) are binary bits. When set to logic 0, $\overline{\text{EOSC}}$ (bit 7) enables the Real Time Clock oscillator. This bit is set to logic 1 as shipped from Dallas Semiconductor to prevent lithium energy consumption during storage and shipment. This bit will normally be turned on by the user during device initialization. However, the oscillator can be turned on and off as necessary by setting this bit to the appropriate level. Bit 6 of this same byte controls the Square Wave Output (Pin 23). When set to logic 0, the Square Wave Output pin will output a 1024 Hz Square Wave Signal. When set to logic 1 the Square Wave Output pin is in a high impedance state. Bit 6 of the Hours Register is defined as the 12- or 24- hour Select Bit. When set to logic 1, the 12-hour format is selected. In the 12-hour format, bit 5 is the AM/PM bit with logic 1 being PM. In the 24-hour mode, bit 5 is the second 10-hour bit (20-23 hours). The Time of Day registers are updated every .01 seconds from the real time clock, except when the TE bit (bit 7 of Register B) is set low or the clock oscillator is not running. The preferred method of synchronizing data access to and from the Watchdog Timekeeper is to access the Command Register by doing a write cycle to address location 0B and setting the TE bit (Transfer Enable) to a logic 0. This will freeze the External Time of Day registers at the present recorded time, allowing access to occur without danger of simultaneous update. When the watch registers have been read or written, a second write cycle to location 0B, setting the TE bit to a logic 1, will put the Time of Day registers back to being updated every 0.01 second. No time is lost in the real time clock because the internal copy of the Time of Day register buffers is continually incremented while the external memory registers are frozen.

An alternate method of reading and writing the Time of Day registers is to ignore synchronization. However, any single read may give erroneous data as the real time clock may be in the process of updating the external memory registers as data is being read. The internal copies of seconds through years are incremented and Time of Day Alarm is checked during the period that hundreds of seconds read 99 and are transferred to the external register when hundredths of seconds roll from 99 to 00. A way of making sure data is valid is to do multiple reads and compare. Writing the registers can also produce erroneous results for the same reasons. A way of making sure that the write cycle has caused proper update is to do read verifies and re-execute the write cycle if data is not correct. While the possibility of erroneous results from reads and write cycles has been stated, it is worth noting that the probability of an incorrect result is kept to a minimum due to the redundant structure of the Watchdog Timekeeper.

TIME OF DAY ALARM REGISTERS

Registers 3, 5, and 7 contain the Time of Day Alarm registers. Bits 3, 4, 5, and 6 of Register 7 will always read 0 regardless of how they are written. Bit 7 of Registers 3, 5, and 7 are mask bits (Figure 3). When all of the mask bits are logic 0, a Time of Day Alarm will only occur when Registers 2, 4, and 6 match the values stored in Registers 3, 5, and 7. An alarm will be generated every day when bit 7 of Register 7 is set to a logic 1. Similarly, an alarm is generated every hour when bit 7 of Registers 7 and 5 is set to a logic 1. When bit 7 of Registers 7, 5, and 3 is set to a logic 1, an alarm will occur every minute when Register 1 (seconds) rolls from 59 to 00.

Time of Day Alarm registers are written and read in the same format as the Time of Day registers. The Time of Day Alarm Flag and Interrupt is always cleared when Alarm registers are read or written.

WATCHDOG ALARM REGISTERS

Registers C and D contain the time for the Watchdog Alarm. The two registers contain a time count from to 99.99 seconds in BCD. The value written into the Watchdog Alarm Registers can be written or read in any order. Any access to Registers C or D will cause the Watchdog Alarm to reinitialize and clears the Watchdog Flag bit and the Watchdog Interrupt Output. When a new value is entered or the Watchdog Registers are read, the Watchdog Timer will start counting down from the entered value to 0. When 0 is reached, the Watchdog Interrupt Output will go to the active state. The Watchdog Timer countdown is interrupted and reinitialized back to the entered value every time either of the registers is accessed. In this manner, controlled periodic accesses to the Watchdog Timer can prevent the Watchdog Alarm from ever going to an active level. If access does not occur, countdown alarm will be repetitive. The Watchdog Alarm registers always read the entered value. The actual countdown register is internal and is not readable. Writing Registers C and D to 0 will disable the Watchdog Alarm feature.

COMMAND REGISTER

Address location 0B is the Command Register where mask bits, control bits, and flag bits reside. Bit 0 is the Time of Day Alarm Flag (TDF). When this bit is set internally to a logic 1, an alarm has occurred. The time of the alarm can be determined by reading the Time of Day Alarm registers. However, if the transfer enable bit is set to logic 0 the Time of Day registers may not reflect the exact time that the alarm occurred. This bit is read only and writing this register has no effect on the bit. The bit is reset when any of the Time of Day Alarm registers are read. Bit 1 is the Watchdog Alarm Flag (WAF). When this bit is set internally to a logic 1, a Watchdog Alarm has occurred. This bit is read only and writing this register has no effect on the bit. The bit is reset when any of the Watchdog Alarm registers are accessed. Bit 2 of the Command Register contains the Time of Day Alarm Mask Bit (TDM). When this bit is written to a logic 1, the Time of Day Alarm Interrupt Output is deactivated regardless of the value of the Time of Day Alarm Flag. When TDM is set to logic 0, the Time of Day Interrupt Output will go to the active state, which is determined by bits 0, 4, 5, and 6 of the Command Register. Bit 3 of the Command Register contains the Watchdog Alarm Mask bit (WAM). When this bit is written to a logic 1, the Watchdog Interrupt Output is deactivated regardless of the value in the Watchdog Alarm registers. When WAM is set to logic 0, the Watchdog Interrupt Output will go to the active state which is determined by bits 1, 4, 5, and 6 of the Command Register. These 4 bits define how Interrupt Output Pins \overline{INTA} and \overline{INTB} (INTB) will be operated. Bit 4 of the Command Register determines whether both interrupts will output a pulse or level when activated. If bit 4 is set to logic 1, the pulse mode is selected and \overline{INTA} will sink current for a minimum of 3 ms and then release. Output \overline{INTB} (INTB) will either sink or source current for a minimum of 3 ms depending on the level of bit 5. When bit 5 is set to logic 1, the B interrupt will source current. When bit 5 is set to logic 0, the B interrupt will sink current. Bit 6 of the Command Register directs which type of interrupt will be present on interrupt pins \overline{INTA} or \overline{INTB} (INTB). When set to logic 1, \overline{INTA} becomes the Time of Day Alarm Interrupt pin and \overline{INTB} (INTB) becomes the Watchdog Interrupt pin. When bit 6 is set to logic 0, the interrupt functions are reversed such that the Time of Day Alarm will be output on \overline{INTB} (INTB) and the Watchdog Interrupt will be output on \overline{INTA} . Caution should be exercised when dynamically setting this bit as the interrupts will be reversed even if in an active state. Bit 7 of the Command Register is for Transfer Enable (TE). The function of this bit is described in the Time of Day registers.

TIME OF DAY ALARM MASK BITS Figure 3

REGISTER			
(3)MINUTES	(5)HOURS	(7)DAYS	
1	1	1	ALARM ONCE PER MINUTE
0	1	1	ALARM WHEN MINUTES MATCH
0	0	1	ALARM WHEN HOURS AND MINUTES MATCH
0	0	0	ALARM WHEN HOURS, MINUTES, AND DAYS MATCH

ABSOLUTE MAXIMUM RATINGS*

Voltage on Any Pin Relative to Ground	-0.3V to +7.0V
Operating Temperature	0°C to 70°C
Storage Temperature	-40°C to +70°C
Soldering Temperature	260°C for 10 seconds (See Note 14)

* This is a stress rating only and functional operation of the device at these or any other conditions above those indicated in the operation sections of this specification is not implied. Exposure to absolute maximum rating conditions for extended periods of time may affect reliability.

RECOMMENDED DC OPERATING CONDITIONS (0°C to 70°C)

PARAMETER	SYMBOL	MIN	TYP	MAX	UNITS	NOTES
Power Supply Voltage	V_{CC}	4.5	5.0	5.5	V	10
Input Logic 1	V_{IH}	2.2		$V_{CC}+0.3$	V	10
Input Logic 0	V_{IL}	-0.3		0.8	V	10

DC ELECTRICAL CHARACTERISTICS (0°C to 70°C; $V_{CC} = 5V \pm 10\%$)

PARAMETER	SYMBOL	MIN	TYP	MAX	UNITS	NOTES
Input Leakage Current	I_{IL}	-1.0		+1.0	μA	
Output Leakage Current	I_{LO}	-1.0		+1.0	μA	
I/O Leakage Current $\overline{CE} \geq V_{IH} \leq V_{CC}$	I_{LIO}	-1.0		+1.0	μA	
Output Current @ 2.4V	I_{OH}	-1.0			mA	
Output Current @ 0.4V	I_{OL}	2.0			mA	13
Standby Current $\overline{CE} = 2.2V$	I_{CCS1}		3.0	7.0	mA	
Standby Current $\overline{CE} > V_{CC} - 0.5$	I_{CCS2}			4.0	mA	
Active Current	I_{CC}			15	mA	
Write Protection Voltage	V_{TP}		4.25		V	

CAPACITANCE ($t_A = 25^\circ C$)

PARAMETER	SYMBOL	MIN	TYP	MAX	UNITS	NOTES
Input Capacitance	C_{IN}		7	10	pF	
Output Capacitance	C_{OUT}		7	10	pF	
Input/Output Capacitance	C_{IO}		7	10	pF	

AC ELECTRICAL CHARACTERISTICS(0°C to 70°C; $V_{CC} = 4.5V$ to $5.5V$)

PARAMETER	SYMBOL	MIN	TYP	MAX	UNITS	NOTES
Read Cycle Time	t_{RC}	150			ns	1
Address Access Time	t_{ACC}			150	ns	
\overline{CE} Access Time	t_{CO}			150	ns	
\overline{OE} Access Time	t_{OE}			60	ns	
\overline{OE} or \overline{CE} to Output Active	t_{COE}	10			ns	
Output High Z from Deselect	t_{OD}			60	ns	
Output Hold from Address Change	t_{OH}	10			ns	
Write Cycle Time	t_{WC}	150			ns	
Write Pulse Width	t_{WP}	140			ns	3
Address Setup Time	t_{AW}	0			ns	
Write Recovery Time	t_{WR}	10			ns	
Output High Z from \overline{WE}	t_{ODW}			50	ns	
Output Active from \overline{WE}	t_{OEW}	10			ns	
Data Setup Time	t_{DS}	45			ns	4
Data Hold Time	t_{DH}	0			ns	4,5
\overline{INTA} , \overline{INTB} Pulse Width	t_{IPW}	3			ns	11,12

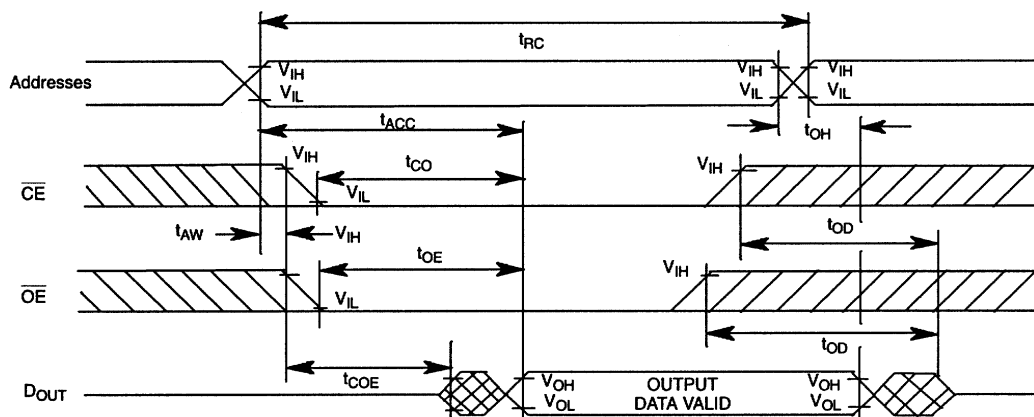
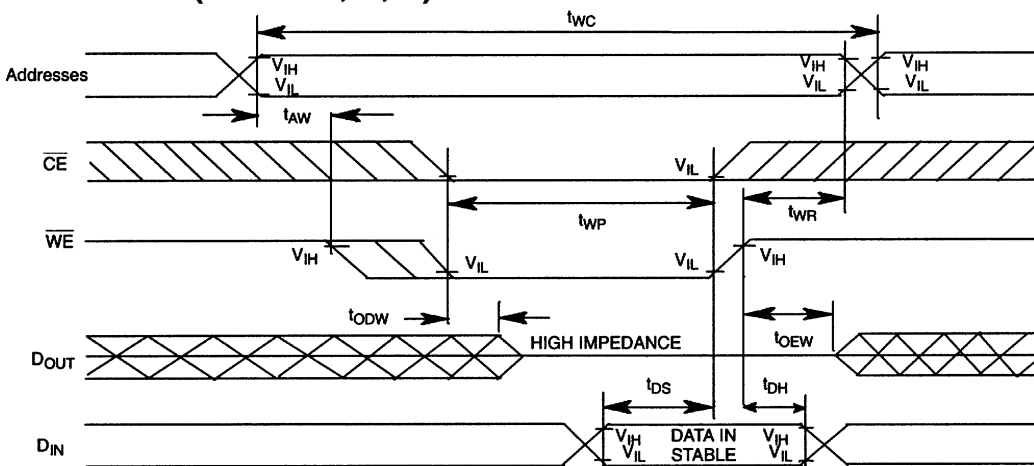
READ CYCLE (NOTE 1)**WRITE CYCLE 1 (Notes 2, 6, 7)**

WRITE CYCLE 2 (Notes 2, 8)

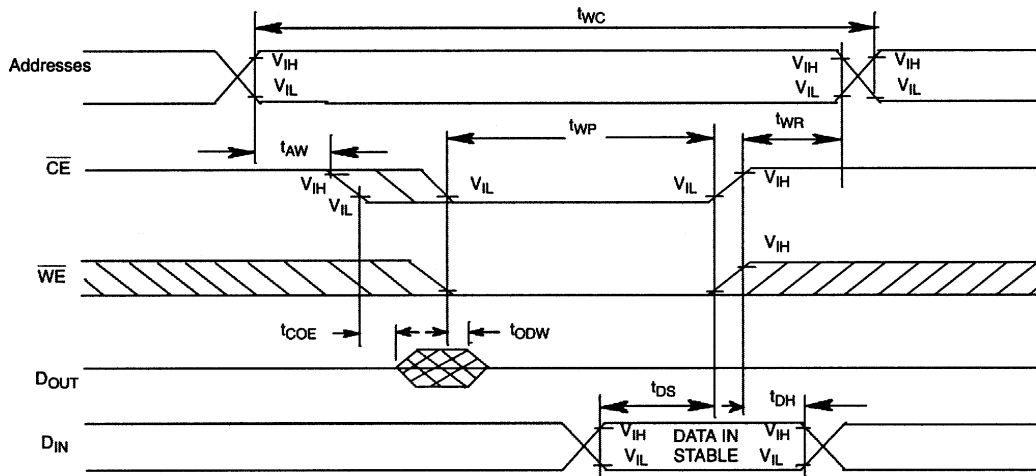

TIMING DIAGRAM: INTERRUPT OUTPUTS PULSE MODE (SEE NOTES 11, 12)

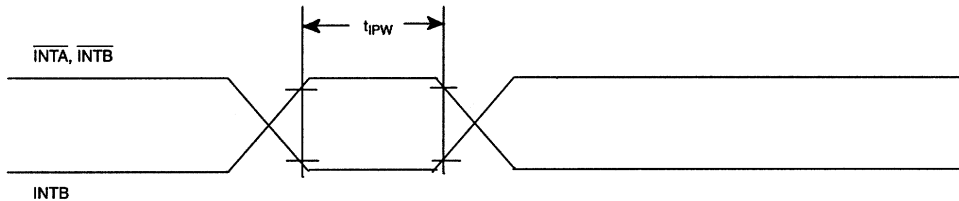

POWER-DOWN/POWER-UP CONDITION

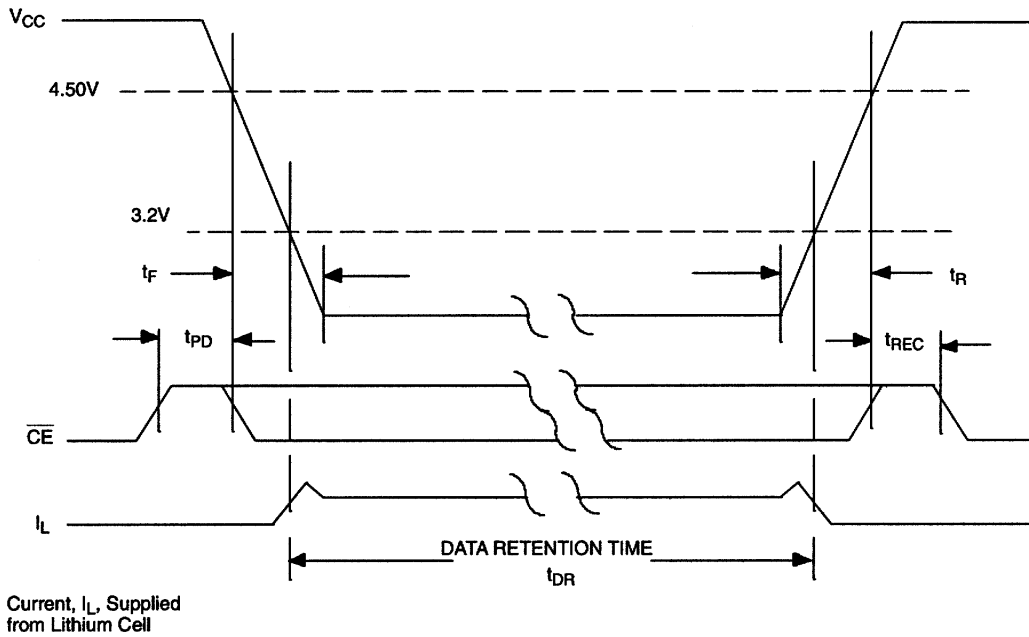

POWER-UP/POWER-DOWN CONDITION

PARAMETER	SYMBOL	MIN	TYP	MAX	UNITS	NOTES
$\overline{\text{CE}}$ at V_{IH} before Power-Down	t_{PD}	0			μs	
V_{CC} slew from 4.5V to 0V ($\overline{\text{CE}}$ at V_{IH})	t_{F}	350			μs	
V_{CC} slew from 0V to 4.5V ($\overline{\text{CE}}$ at V_{IH})	t_{R}	100			μs	
$\overline{\text{CE}}$ at V_{IH} after Power Up	t_{REC}			150	ns	

 $(t_{\text{A}}=25^{\circ}\text{C})$

PARAMETER	SYMBOL	MIN	TYP	MAX	UNITS	NOTES
Expected Data Retention Time	t_{DR}	10			years	9

WARNING:

Under no circumstances are negative undershoots, of any amplitude, allowed when device is in battery backup mode.

NOTES:

1. $\overline{\text{WE}}$ is high for a read cycle.
2. $\overline{\text{OE}} = V_{\text{IH}}$ or V_{IL} . If $\overline{\text{OE}} = V_{\text{IH}}$ during write cycle, the output buffers remain in a high impedance state.
3. t_{WP} is specified as the logical AND of the $\overline{\text{CE}}$ and $\overline{\text{WE}}$. t_{WP} is measured from the latter of $\overline{\text{CE}}$ or $\overline{\text{WE}}$ going low to the earlier of $\overline{\text{CE}}$ or $\overline{\text{WE}}$ going high.
4. t_{DS} or t_{DH} are measured from the earlier of $\overline{\text{CE}}$ or $\overline{\text{WE}}$ going high.
5. t_{DH} is measured from $\overline{\text{WE}}$ going high. If $\overline{\text{CE}}$ is used to terminate the write cycle, then $t_{\text{DH}} = 20$ ns.
6. If the $\overline{\text{CE}}$ low transition occurs simultaneously with or later than the $\overline{\text{WE}}$ low transition in Write Cycle 1, the output buffers remain in a high impedance state during this period.
7. If the $\overline{\text{CE}}$ high transition occurs prior to or simultaneously with the $\overline{\text{WE}}$ high transition, the output buffers remain in a high impedance state during this period.
8. If $\overline{\text{WE}}$ is low or the $\overline{\text{WE}}$ low transition occurs prior to or simultaneously with the $\overline{\text{CE}}$ low transition, the output buffers remain in a high impedance state during this period.
9. Each DS1286 is marked with a four-digit date code AABB. AA designates the year of manufacture. BB designates the week of manufacture. The expected t_{DR} is defined as starting at the date of manufacture.
10. All voltages are referenced to ground.
11. Applies to both interrupt pins when the alarms are set to pulse.
12. Interrupt output occurs within 100 ns on the alarm condition existing.
13. Both $\overline{\text{INTA}}$ and $\overline{\text{INTB}}$ ($\overline{\text{INTB}}$) are open drain outputs.
14. Real-Time Clock Modules can be successfully processed through conventional wave-soldering techniques as long as temperature exposure to the lithium energy source contained within does not exceed +85°C. Post-solder cleaning with water washing techniques is acceptable, provided that ultrasonic vibration is not used.

AC TEST CONDITIONS

Output Load: 100 pF + 1TTL Gate

Input Pulse Levels: 0-3.0V

Timing Measurement Reference Levels

Input: 1.5V

Output: 1.5V

Input Pulse Rise and Fall Times: 5 ns.

DS1286 WATCHDOG TIMEKEEPER

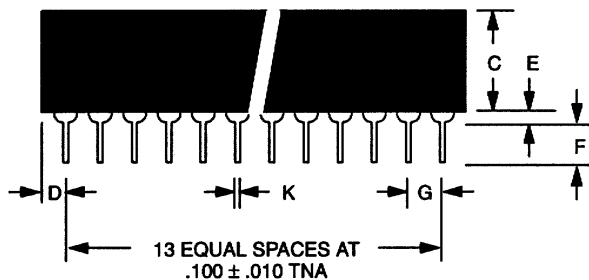
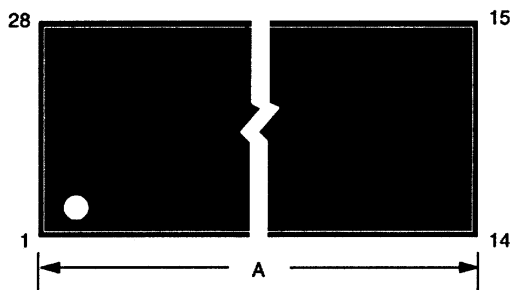

PKG DIM	28-PIN	
	MIN	MAX
A IN.	1.520	1.540
MM	38.61	39.12
B IN.	0.695	0.720
MM	17.65	18.29
C IN.	0.350	0.375
MM	8.89	9.52
D IN.	0.100	0.130
MM	2.54	3.30
E IN.	0.015	0.030
MM	0.38	0.76
F IN.	0.110	0.140
MM	2.79	3.56
G IN.	0.090	0.110
MM	2.29	2.79
H IN.	0.590	0.630
MM	14.99	16.00
J IN.	0.008	0.012
MM	0.20	0.30
K IN.	0.015	0.021
MM	0.38	0.53

NOTE: PINS 2,3,21,24 AND 25 ARE MISSING BY DESIGN

