

MOSEL

MS62256

MOSEL-VITELIC

32K x 8 CMOS Static RAM

T 46-23-13

FEATURES

- High-speed – 70/85/100/120 ns
- Low Power dissipation:
 - MS62256L
 - 385mW (Max.) Operating
 - 550 μ W (Typ.) Power Down
- Fully static operation
- All inputs and outputs directly TTL compatible
- Three state outputs
- Ultra low data retention supply current at $V_{CC} = 2V$

DESCRIPTION

The MOSEL MS62256 is a 262,144-bit static random access memory organized as 32,768 words by 8 bits and operates from a single 5 volt supply. It is built with MOSEL's high performance twin tub CMOS process. Inputs and three-state outputs are TTL compatible and allow for direct interfacing with common system bus structures. The MS62256 is available in a standard 28-pin 600 mil plastic DIP package and 330 mil SOP.

PIN CONFIGURATIONS

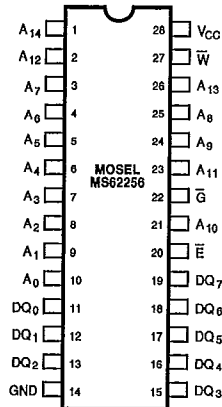

FUNCTIONAL BLOCK DIAGRAM

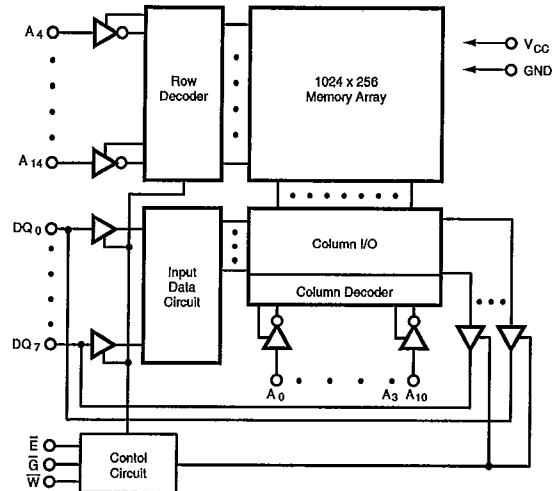

MOSEL-VITELIC

MS62256

T-46-23-13

PIN DESCRIPTIONS

A₀ - A₁₄ Address Inputs

These 15 address inputs select one of the 32768 8-bit words in the RAM.

 \bar{E} Chip Enable Input

\bar{E} is active LOW. The chip enable must be active to read from or write to the device. If it is not active, the device is deselected and is in a standby power mode. The DQ pins will be in the high-impedance state when deselected.

 \bar{G} Output Enable Input

The output enable input is active LOW. If the output enable is active while the chip is selected and the write enable is inactive, data will be present on the DQ pins and they will be enabled. The DQ pins will be in the high impedance state when \bar{G} is inactive.

 \bar{W} Write Enable Input

The write enable input is active LOW and controls read and write operations. With the chip enabled, when \bar{W} is HIGH and \bar{G} is LOW, output data will be present at the DQ pins; when \bar{W} is LOW, the data present on the DQ pins will be written into the selected memory location.

DQ₀ - DQ₇ Data Input/Output Ports

These 8 bidirectional ports are used to read data from or write data into the RAM.

V_{CC} Power Supply**GND Ground**

3

TRUTH TABLE

MODE	\bar{E}	\bar{G}	\bar{W}	I/O OPERATION
Standby	H	X	X	High Z
Read	L	L	H	D _{OUT}
Read	L	H	H	High Z
Write	L	X	L	D _{IN}

ABSOLUTE MAXIMUM RATINGS ⁽¹⁾

SYMBOL	PARAMETER	RATING	UNITS
V _{CC}	Supply Voltage	-0.3 to 7	V
V _{IN}	Input Voltage	-0.3 to 7	
V _{DQ}	Input/Output Voltage Applied	-0.3 to 6	
T _{BIAS}	Temperature Under Bias	Plastic -10 to +125	°C
T _{STG}	Storage Temperature	Plastic -40 to +150	°C
P _D	Power Dissipation	1.0	W
I _{OUT}	DC Output Current	50	mA

1. Stresses greater than those listed under ABSOLUTE MAXIMUM RATINGS may cause permanent damage to the device. This is a stress rating only and functional operation of the device at these or any other conditions above those indicated in the operational sections of this specification is not implied. Exposure to absolute maximum rating conditions for extended periods may affect reliability.

OPERATING RANGE

RANGE	AMBIENT TEMPERATURE	V _{CC}
Commercial	0°C to +70°C	5V ± 10%

MS62256

MOSEL-VITELIC

T-46-23-13

DC ELECTRICAL CHARACTERISTICS (over the commercial operating range)

PARAMETER NAME	PARAMETER	TEST CONDITIONS	-70, -85			-10, -12			UNITS
			MIN.	TYP. ⁽¹⁾	MAX.	MIN.	TYP. ⁽¹⁾	MAX.	
V _{IL}	Guaranteed Input Low Voltage ⁽²⁾⁽³⁾		-0.3	-	+0.8	-0.3	-	+0.8	V
V _{IH}	Guaranteed Input High Voltage ⁽²⁾		2.2	-	6.0	2.2	-	6.0	V
I _{IL}	Input Leakage Current	V _{CC} = Max, V _{IN} = 0V to V _{CC}	-	-	2	-	-	2	μA
I _{OL}	Output Leakage Current	V _{CC} = Max, $\bar{E} = V_{IH}$, or $\bar{G} = V_{IH}$, V _{IN} = 0V to V _{CC}	-	-	2	-	-	2	μA
V _{OL}	Output Low Voltage	V _{CC} = Min, I _{OL} = 4mA	-	-	0.4	-	-	0.4	V
V _{OH}	Output High Voltage	V _{CC} = Min, I _{OH} = -1mA	2.4	3.5	-	2.4	3.5	-	V
I _{CC}	Operating Power Supply Current	V _{CC} = Max, $\bar{E} = V_{IL}$, I _{I/O} = 0mA, F _{max} ⁽⁴⁾	-	-	85	-	-	70	mA
I _{CCSB}	Standby Power Supply Current	V _{CC} = Max, $\bar{E} = V_{IH}$, I _{I/O} = 0mA	-	-	3	-	-	3	mA
I _{CCSB1}	Power Down Power Supply Current	V _{CC} = Max, $\bar{E} \geq V_{CC} - 0.2V$	MS62256L			-	-	0.1	mA
		V _{IN} $\geq V_{CC} - 0.2V$ or V _{IN} $\leq 0.2V$	MS62256			-	-	1	mA

1. Typical characteristics are at V_{CC} = 5V, T_A = 25°C.
2. These are absolute values with respect to device ground and all overshoots due to system or tester noise are included.
3. V_{IL} (Min.) = -3.0V for pulse width ≤ 20ns
3. F_{max} = 1/t_{RC}.

CAPACITANCE⁽¹⁾ (T_A = 25°C, f = 1.0MHz)

SYMBOL	PARAMETER	CONDITIONS	MAX.	UNIT
C _{IN}	Input Capacitance	V _{IN} = 0V	8	pF
C _{YO}	Input/Output Capacitance	V _{I/O} = 0V	10	pF

1. This parameter is guaranteed and not tested.

DATA RETENTION CHARACTERISTICS⁽¹⁾ (over the commercial operating range)

SYMBOL	PARAMETER	TEST CONDITIONS	MIN.	TYP. ⁽²⁾	MAX. ⁽³⁾	UNITS
V _{DR}	V _{CC} for Data Retention	$\bar{E} \geq V_{CC} - 0.2V$, $\bar{G} \geq V_{CC} - 0.2V$, V _{IN} $\geq V_{CC} - 0.2V$ or V _{IN} $\leq 0.2V$	2.0	-	-	V
I _{CCDR}	Data Retention Current	$\bar{E}_1 \geq V_{CC} - 0.2V$, $\bar{G} \geq V_{CC} - 0.2V$, V _{IN} $\geq V_{CC} - 0.2V$ or V _{IN} $\leq 0.2V$	-	2	50	μA
t _{CDR}	Chip Deselect to Data Retention Time	See Retention Waveform	0	-	-	ns
t _R	Operation Recovery Time		t _{RC} ⁽⁴⁾	-	-	-

1. Applies to L version only
2. V_{CC} = 2V, T_A = +25°C
3. V_{CC} = 3V
4. t_{RC} = Read Cycle Time

TIMING WAVEFORM LOW V_{CC} DATA RETENTION WAVEFORM

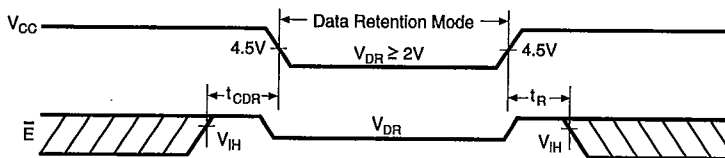

AC TEST CONDITIONS

Input Pulse Levels	0V to 3.0V
Input Rise and Fall Times	5ns
Timing Reference Level	1.5V

KEY TO SWITCHING WAVEFORMS

WAVEFORM	INPUTS	OUTPUTS
	MUST BE STEADY	WILL BE STEADY
	MAY CHANGE FROM H TO L	WILL BE CHANGING FROM H TO L
	MAY CHANGE FROM L TO H	WILL BE CHANGING FROM L TO H
	DON'T CARE: ANY CHANGE PERMITTED	CHANGING: STATE UNKNOWN
	DOES NOT APPLY	CENTER LINE IS HIGH IMPEDANCE "OFF" STATE

3

AC TEST LOADS AND WAVEFORMS

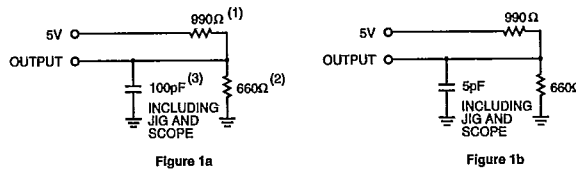

Equivalent to:

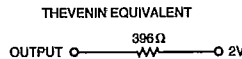

ALL INPUT PULSES

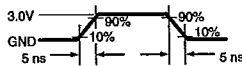

Figure 2

- 1. For 100 ns version, 1000Ω
- 2. For 100 ns version, 670Ω
- 3. For 100 ns version, 100pF

AC ELECTRICAL CHARACTERISTICS (over the commercial operating range)

READ CYCLE

JEDEC PARAMETER NAME	PARAMETER NAME	PARAMETER	MS62256L-70		MS62256L-85		MS62256L-10		MS62256L-12		UNIT
			MIN.	MAX.	MIN.	MAX.	MIN.	MAX.	MIN.	MAX.	
t _{AVAX}	t _{RC}	Read Cycle Time	70	-	85	-	100	-	120	-	ns
t _{AVQV}	t _{AA}	Address Access Time	-	70	-	85	-	100	-	120	ns
t _{ELQV}	t _{ACS}	Chip Enable Access Time	-	70	-	85	-	100	-	120	ns
t _{GLOX}	t _{OE}	Output Enable to Output Valid	-	35	-	40	-	50	-	60	ns
t _{EHQZ}	t _{CLZ}	Chip Enable to Output Low Z	5	-	5	-	10	-	5	-	ns
t _{GLOX}	t _{OLZ}	Output Enable to Output in Low Z	5	-	5	-	10	-	5	-	ns
t _{EHQZ}	t _{CHZ}	Chip Disable to Output in High Z	0	30	0	35	0	35	0	40	ns
t _{GHAZ}	t _{OHZ}	Output Disable to Output in High Z	0	30	0	35	0	35	0	40	ns
t _{AXQX}	t _{OH}	Output Hold from Address Change	10	-	10	-	10	-	10	-	ns

MS62256

MOSEL-VITELIC

T-46-23-13

SWITCHING WAVEFORMS (READ CYCLE)

READ CYCLE 1⁽¹⁾

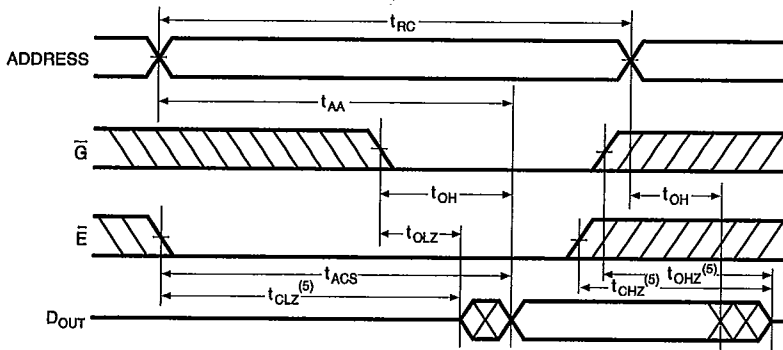

READ CYCLE 2^(1, 2, 4)

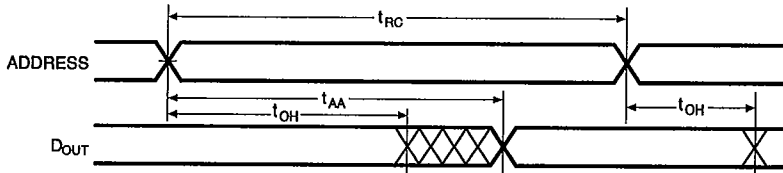

READ CYCLE 3^(1, 3, 4)

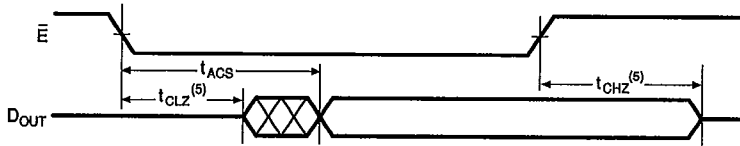

NOTES:

1. \bar{W} is High for READ Cycle.
2. Device is continuously selected $\bar{E} = V_{IL}$.
3. Address valid prior to or coincident with \bar{E} transition low.
4. $\bar{G} = V_{IL}$.
5. Transition is measured $\pm 500mV$ from steady state with $C_L = 5pF$ as shown in Figure 1b on page 4. This parameter is guaranteed and not 100% tested.

AC ELECTRICAL CHARACTERISTICS (over the commercial operating range)

T-46-23-13

WRITE CYCLE

3

JEDEC PARAMETER NAME	PARAMETER NAME	PARAMETER	MS62256L-70		MS62256L-85		MS62256L-10		MS62256L-12		UNIT
			MIN.	MAX.	MIN.	MAX.	MIN.	MAX.	MIN.	MAX.	
t _{AVAX}	t _{WC}	Write Cycle Time	70	-	85	-	100	-	120	-	ns
t _{ELWH}	t _{CW}	Chip Enable to End of Write	45	-	60	-	70	-	85	-	ns
t _{AVWL}	t _{AS}	Address Set up Time	0	-	0	-	0	-	0	-	ns
t _{AVWH}	t _{AW}	Address Valid to End of Write	65	-	65	-	70	-	85	-	ns
t _{WLWH}	t _{WP}	Write Pulse Width	40	-	40	-	50	-	70	-	ns
t _{WHAX}	t _{WR}	Write Recovery Time	5	-	5	-	0	-	0	-	ns
t _{WLOZ}	t _{WHZ}	Write to Output in High Z	0	25	0	30	0	35	0	40	ns
t _{DVWH}	t _{DW}	Data Valid to End of Write	30	-	30	-	30	-	50	-	ns
t _{WHDX}	t _{DH}	Data Hold from Write Time	5	-	5	-	0	-	0	-	ns
t _{GHZQ}	t _{OHZ}	Output Disable to Output in High Z	0	25	0	30	0	35	0	40	ns
t _{WHOX}	t _{OW}	Output Active from End of Write	5	-	5	-	5	-	5	-	ns

SWITCHING WAVEFORMS (WRITE CYCLE)

WRITE CYCLE 1⁽¹⁾

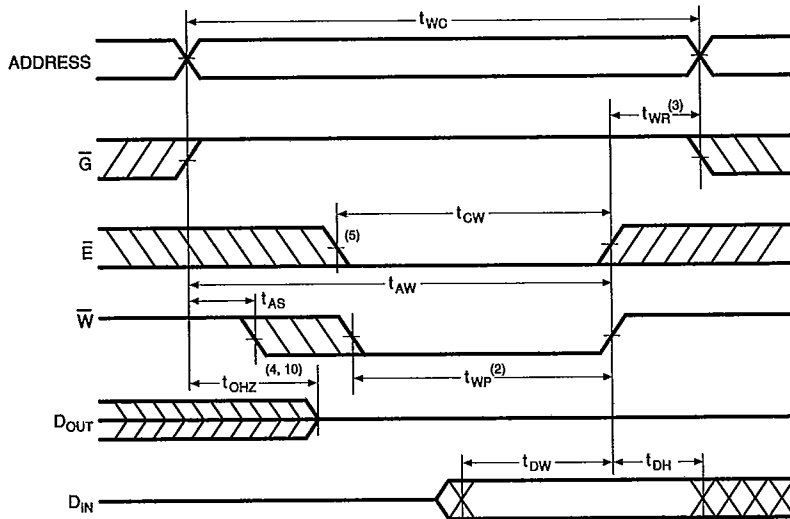

MS62256

MOSEL-VITELIC

SWITCHING WAVEFORMS (WRITE CYCLE)

T-46-23-13

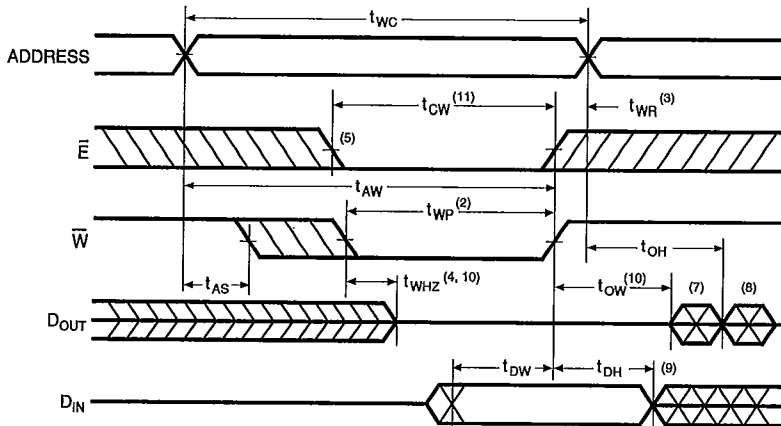
WRITE CYCLE 2^(1,6)

NOTES:

- \bar{W} must be high during address transitions.
- The internal write time of the memory is defined by the overlap \bar{E} active and \bar{W} low. Both signals must be active to initiate and any one signal can terminate a write by going inactive. The data input setup and hold timing should be referenced to the second transition edge of the signal that terminates the write.
- T_{WR} is measured from the earlier of \bar{E} or \bar{W} going high at the end of write cycle.
- During this period, DQ pins are in the output state so that the input signals of opposite phase to the outputs must not be applied.
- If the \bar{E} low transition occurs simultaneously with the \bar{W} low transitions or after the \bar{W} low transition, outputs remain in a high impedance state.
- \bar{G} is continuously low ($\bar{G} = V_{IL}$).
- D_{OUT} is the same phase of write data of this write cycle.
- D_{OUT} is the read data of next address.
- If \bar{E} is low during this period, DQ pins are in the output state. Then the data input signals of opposite phase to the outputs must not be applied to them.
- Transition is measured $\pm 50mV$ from steady state with $C_L = 5pF$ as shown in Figure 1b. This parameter is guaranteed and not 100% tested.
- t_{CW} is measured from \bar{E} going low to the end of write.

ORDERING INFORMATION

SPEED (ns)	ORDERING PART NUMBER	PACKAGE REFERENCE NO.	TEMPERATURE RANGE
70	MS62256L-70FC	S28-3	0°C to +70°C
70	MS62256L-70PC	P28-1	0°C to +70°C
85	MS62256L-85FC	S28-3	0°C to +70°C
85	MS62256L-85PC	P28-1	0°C to +70°C
100	MS62256L-10FC	S28-2	0°C to +70°C
100	MS62256L-10PC	P28-1	0°C to +70°C
120	MS62256L-12FC	S28-2	0°C to +70°C
120	MS62256L-12PC	P28-1	0°C to +70°C