



# Cascadable Silicon Bipolar MMIC Amplifier

## Technical Data

### MSA-1104

#### Features

- **High Dynamic Range**  
Cascadable 50  $\Omega$  or 75  $\Omega$  Gain Block
- **3 dB Bandwidth:**  
50 MHz to 1.3 GHz
- **17.5 dBm Typical  $P_{1\text{ dB}}$  at 0.5 GHz**
- **12 dB Typical 50  $\Omega$  Gain at 0.5 GHz**
- **3.6 dB Typical Noise Figure at 0.5 GHz**
- **Low Cost Plastic Package**

#### Description

The MSA-1104 is a high performance silicon bipolar Monolithic Microwave Integrated Circuit (MMIC) housed in a low cost

plastic package. This MMIC is designed for high dynamic range in either 50 or 75  $\Omega$  systems by combining low noise figure with high IP<sub>3</sub>. Typical applications include narrow and broadband linear amplifiers in commercial and industrial systems.

The MSA-series is fabricated using Agilent's 10 GHz  $f_T$ , 25 GHz  $f_{MAX}$  silicon bipolar MMIC process which uses nitride self-alignment, ion implantation, and gold metallization to achieve excellent performance, uniformity and reliability. The use of an external bias resistor for temperature and current stability also allows bias flexibility.

#### 04A Plastic Package

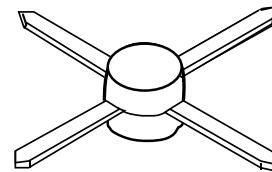

#### Typical Biasing Configuration

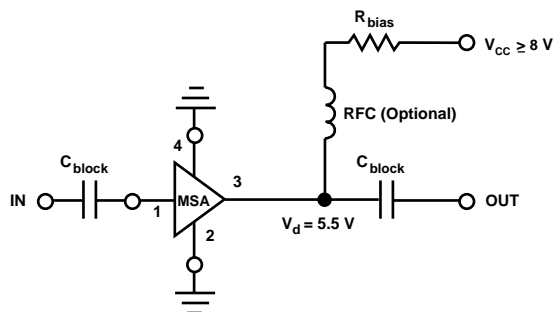

## MSA-1104 Absolute Maximum Ratings

Parameter	Absolute Maximum <sup>[1]</sup>
Device Current	80 mA
Power Dissipation <sup>[2,3]</sup>	550 mW
RF Input Power	+1 dBm
Junction Temperature	150°C
Storage Temperature	-65 to 150°C

### Thermal Resistance<sup>[2,4]</sup>:

$$\theta_{jc} = 115^{\circ}\text{C/W}$$

#### Notes:

1. Permanent damage may occur if any of these limits are exceeded.
2.  $T_{\text{CASE}} = 25^{\circ}\text{C}$ .
3. Derate at  $8.7 \text{ mW}/^{\circ}\text{C}$  for  $T_{\text{C}} > 87^{\circ}\text{C}$ .
4. See MEASUREMENTS section "Thermal Resistance" for more information.

## Electrical Specifications<sup>[1]</sup>, $T_{\text{A}} = 25^{\circ}\text{C}$

Symbol	Parameters and Test Conditions: $I_{\text{d}} = 60 \text{ mA}$ , $Z_{\text{o}} = 50 \Omega$	Units	Min.	Typ.	Max.	
G <sub>P</sub>	Power Gain ( $ S_{21} ^2$ )	$f = 0.05 \text{ GHz}$			12.7	
		$f = 0.5 \text{ GHz}$	dB	10.0	12.0	
		$f = 1.0 \text{ GHz}$	dB		10.5	
$\Delta G_{\text{P}}$	Gain Flatness	$f = 0.1 \text{ to } 1.0 \text{ GHz}$	dB		$\pm 1.0$	
$f_{3 \text{ dB}}$	3 dB Bandwidth <sup>[2]</sup>		GHz		1.3	
VSWR	Input VSWR	$f = 0.1 \text{ to } 1.0 \text{ GHz}$			1.5:1	
	Output VSWR	$f = 0.1 \text{ to } 1.0 \text{ GHz}$			1.7:1	
NF	50 $\Omega$ Noise Figure	$f = 0.5 \text{ GHz}$	dB		3.6	
$P_{1 \text{ dB}}$	Output Power at 1 dB Gain Compression	$f = 0.5 \text{ GHz}$	dBm		17.5	
IP <sub>3</sub>	Third Order Intercept Point	$f = 0.5 \text{ GHz}$	dBm		30	
t <sub>D</sub>	Group Delay	$f = 0.5 \text{ GHz}$	psec		200	
V <sub>d</sub>	Device Voltage		V	4.4	5.5	6.6
dV/dT	Device Voltage Temperature Coefficient		mV/°C		-8.0	

#### Notes:

1. The recommended operating current range for this device is 40 to 70 mA. Typical performance as a function of current is on the following page.
2. Referenced from 50 MHz gain (G<sub>P</sub>).

### MSA-1104 Typical Scattering Parameters ( $Z_0 = 50 \Omega$ , $T_A = 25^\circ\text{C}$ , $I_d = 60 \text{ mA}$ )

Freq. GHz	$S_{11}$		$S_{21}$			$S_{12}$			$S_{22}$		k
	Mag	Ang	dB	Mag	Ang	dB	Mag	Ang	Mag	Ang	
.0005	.76	-22	19.3	9.19	167	-24.4	.060	54	.77	-22	0.48
.005	.20	-79	13.7	4.83	164	-16.5	.149	12	.21	-83	0.96
.025	.05	-78	12.8	4.35	174	-16.2	.154	2	.06	-101	1.07
.050	.04	-75	12.7	4.31	174	-16.4	.151	2	.05	-136	1.09
.100	.04	-81	12.6	4.29	171	-16.4	.152	2	.05	-137	1.09
.200	.04	-93	12.6	4.24	164	-16.3	.153	3	.07	-135	1.09
.300	.06	-105	12.4	4.18	156	-16.2	.155	4	.10	-136	1.08
.400	.07	-115	12.3	4.11	148	-16.0	.158	5	.12	-139	1.07
.500	.09	-124	12.1	4.01	141	-15.8	.162	6	.15	-144	1.06
.600	.11	-132	11.8	3.91	134	-15.6	.166	7	.17	-150	1.06
.700	.13	-140	11.6	3.80	126	-15.4	.170	7	.19	-156	1.05
.800	.15	-147	11.3	3.68	120	-15.2	.174	7	.22	-161	1.04
.900	.16	-154	11.0	3.56	113	-14.9	.180	7	.24	-168	1.03
1.000	.18	-161	10.7	3.43	106	-14.7	.184	6	.26	-173	1.03
1.500	.28	171	9.1	2.85	77	-13.5	.211	2	.35	163	0.99
2.000	.37	149	7.6	2.39	52	-13.0	.224	-5	.43	140	0.99
2.500	.45	133	6.1	2.02	33	-12.7	.231	-10	.47	125	1.02
3.000	.52	118	4.6	1.69	14	-12.6	.234	-16	.50	112	1.05

A model for this device is available in the DEVICE MODELS section.

### Typical Performance, $T_A = 25^\circ\text{C}$ , $Z_0 = 50 \Omega$

(unless otherwise noted)

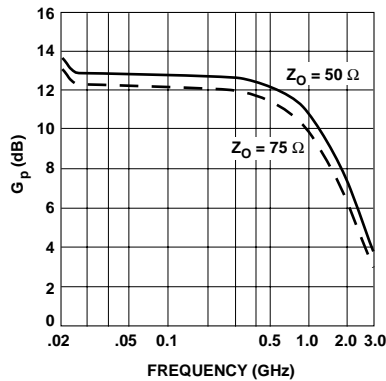

Figure 1. Typical Power Gain vs. Frequency,  $I_d = 60 \text{ mA}$ .

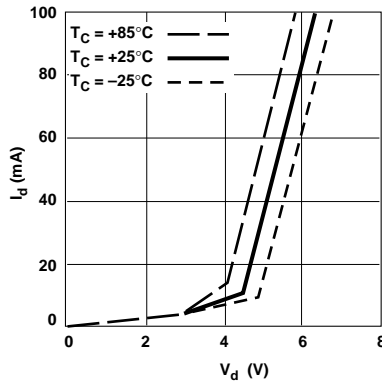

Figure 2. Device Current vs. Voltage.

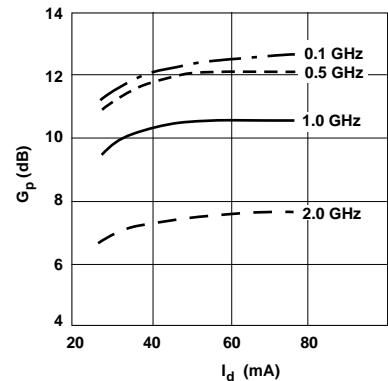

Figure 3. Power Gain vs. Current.

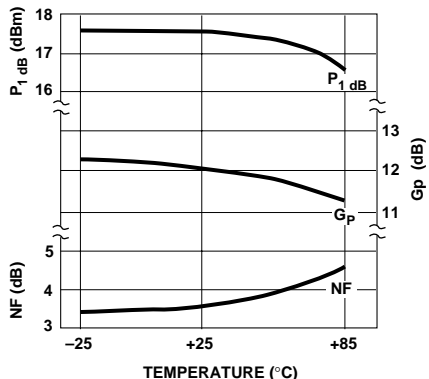

Figure 4. Output Power at 1 dB Gain Compression, Noise Figure and Power Gain vs. Case Temperature,  $f = 0.5 \text{ GHz}$ ,  $I_d = 60 \text{ mA}$ .

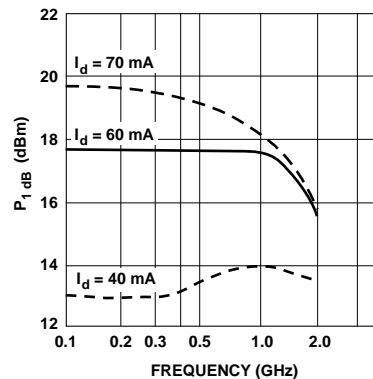

Figure 5. Output Power at 1 dB Gain Compression vs. Frequency.

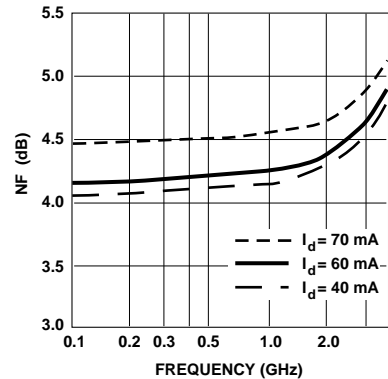

Figure 6. Noise Figure vs. Frequency.



## 04A Plastic Package Dimensions

