

Hyper Mini TOPLED® RG Hyper-Bright LED

LS M776, LA M776, LO M776
LY M776

Besondere Merkmale

- Gehäusefarbe: weiß
- als optischer Indikator einsetzbar
- zur Hinterleuchtung, Lichtleiter- und Linseneinkopplung
- für alle SMT-Bestück- und Löttechniken geeignet
- gegurtet (8-mm-Filmgurt)

Features

- color of package: white
- for use as optical indicator
- for backlighting, optical coupling into light pipes and lenses
- suitable for all SMT assembly and soldering methods
- available taped on reel (8 mm tape)

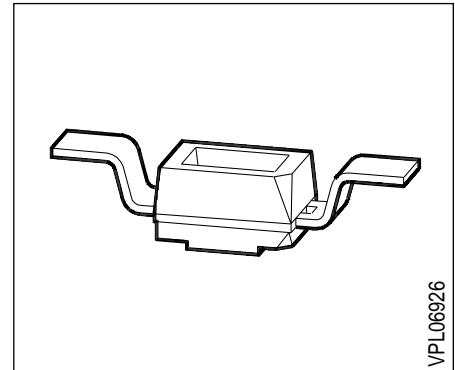

Typ Type	Emissions- farbe Color of Emission	Farbe der Licht- austrittsfläche Color of the Light Emitting Area	Lichtstärke Luminous Intensity $I_F = 20 \text{ mA}$ $I_V \text{ (mcd)}$	Lichtstrom Luminous Flux $I_F = 20 \text{ mA}$ $\Phi_V \text{ (lm)}$	Bestellnummer Ordering Code
LS M776-MQ LS M776-N LS M776-P LS M776-Q LS M776-NR	super-red	colorless clear	16 ... 125 25 ... 50 40 ... 80 63 ... 125 25 ... 200	- 100 (typ.) 180 (typ.) 300 (typ.) -	Q62703-Q3859 Q62703-Q3860 Q62703-Q3861 Q62703-Q3862 Q62703-Q3863
LA M776-NR LA M776-P LA M776-Q LA M776-R LA M776-PS	amber	colorless clear	25 ... 200 40 ... 80 63 ... 125 100 ... 200 40 ... 320	- 180 (typ.) 300 (typ.) 450 (typ.) -	Q62703-Q3864 Q62703-Q3865 Q62703-Q3866 Q62703-Q3867 Q62703-Q3868
LO M776-NR LO M776-P LO M776-Q LO M776-R LO M776-PS	orange	colorless clear	25 ... 200 40 ... 80 63 ... 125 100 ... 200 40 ... 320	- 180 (typ.) 300 (typ.) 450 (typ.) -	Q62703-Q3869 Q62703-Q3870 Q62703-Q3871 Q62703-Q3872 Q62703-Q3873
LY M776-NR LY M776-P LY M776-Q LY M776-R LY M776-PS	yellow	colorless clear	25 ... 200 40 ... 80 63 ... 125 100 ... 200 40 ... 320	- 180 (typ.) 300 (typ.) 450 (typ.) -	Q62703-Q3874 Q62703-Q3875 Q62703-Q3876 Q62703-Q3877 Q62703-Q3878

Streuung der Lichtstärke in einer Verpackungseinheit $I_{V \max} / I_{V \min} \leq 2.0$.

Luminous intensity ratio in one packaging unit $I_{V \max} / I_{V \min} \leq 2.0$.

Grenzwerte
Maximum Ratings

Bezeichnung Parameter	Symbol Symbol	Werte Values		Einheit Unit
		LS, LO, LA	LY	
Betriebstemperatur Operating temperature range	T_{op}	– 55 ... + 100		°C
Lagertemperatur Storage temperature range	T_{stg}	– 55 ... + 100		°C
Sperrschichttemperatur Junction temperature	T_j	+ 100		°C
Durchlaßstrom Forward current	I_F	30	20	mA
Stoßstrom Surge current $t \leq 10 \mu s, D = 0.005$	I_{FM}	to be defined		A
Sperrspannung ¹⁾ Reverse voltage ¹⁾	V_R	3		V
Verlustleistung Power dissipation	P_{tot}	80 ²⁾	55 ²⁾	mW
Wärmewiderstand Thermal resistance Sperrschicht / Umgebung Junction / air Montage auf PC-board*) (Padgröße $\geq 16 \text{ mm}^2$) mounted on PC board*) (pad size $\geq 16 \text{ mm}^2$)	$R_{th JA}$	630 ²⁾	500	K/W

1) Belastung in Sperrichtung sollte vermieden werden.

1) Reverse biasing should be avoided.

2) vorläufig/preliminary

*) PC-board: FR4

Kennwerte ($T_A = 25\text{ °C}$)

Characteristics

Bezeichnung Parameter	Symbol Symbol	Werte Values				Einheit Unit
		LS	LA	LO	LY	
Wellenlänge des emittierten Lichtes (typ.) Wavelength at peak emission (typ.) $I_F = 20\text{ mA}$	λ_{peak}	645	622	610	591	nm
Dominantwellenlänge (typ.) Dominant wavelength (typ.) $I_F = 20\text{ mA}$	λ_{dom}	632	615	605	587	nm
Spektrale Bandbreite bei 50% $I_{\text{rel max}}$ (typ.) Spectral bandwidth at 50% $I_{\text{rel max}}$ (typ.) $I_F = 20\text{ mA}$	$\Delta\lambda$	16	16	16	15	nm
Abstrahlwinkel bei 50% I_v (Vollwinkel) Viewing angle at 50% I_v	2ϕ	120	120	120	120	Grad deg.
Durchlaßspannung (typ.) Forward voltage (max.) $I_F = 20\text{ mA}$	V_F V_F	2.0 2.6	2.0 2.6	2.0 2.6	2.0 2.6	V V
Sperrstrom (typ.) Reverse current (max.) $V_R = 3\text{ V}$	I_R I_R	0.01 10	0.01 10	0.01 10	0.01 10	μA μA
Temperaturkoeffizient von λ_{dom} ($I_F = 20\text{ mA}$) Temperature coefficient of λ_{dom} ($I_F = 20\text{ mA}$)	TC_λ	0.014	0.062	0.067	0.096	nm/K
Temperaturkoeffizient von λ_{peak} , $I_F = 20\text{ mA}$ (typ.) Temperature coefficient of λ_{peak} , $I_F = 20\text{ mA}$ (typ.)	TC_λ	0.14	0.13	0.13	0.13	nm/K
Temperaturkoeffizient von V_F , $I_F = 20\text{ mA}$ (typ.) Temperature coefficient of V_F , $I_F = 20\text{ mA}$ (typ.)	TC_V	-1.95	-1.78	-1.67	-2.51	mV/K

Relative spektrale Emission $I_{rel} = f(\lambda)$, $T_A = 25\text{ }^\circ\text{C}$, $I_F = 10\text{ mA}$

Relative spectral emission

$V(\lambda)$ = spektrale Augenempfindlichkeit

Standard eye response curve

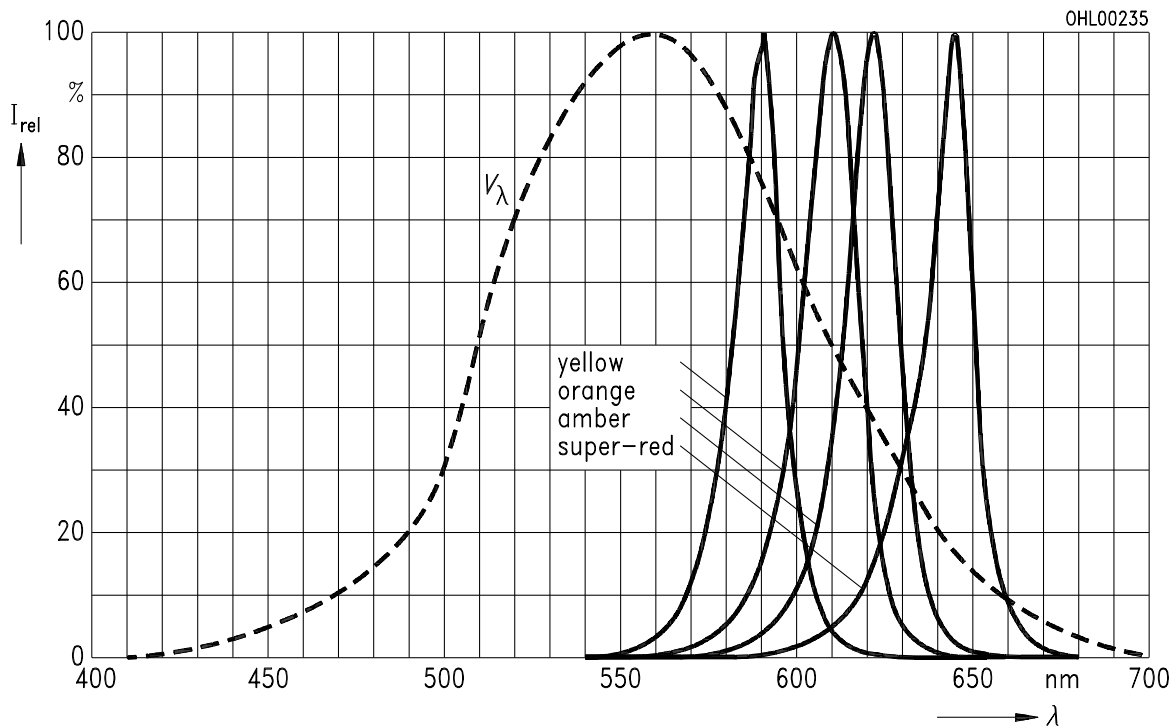

Abstrahlcharakteristik $I_{rel} = f(\varphi)$

Radiation characteristic

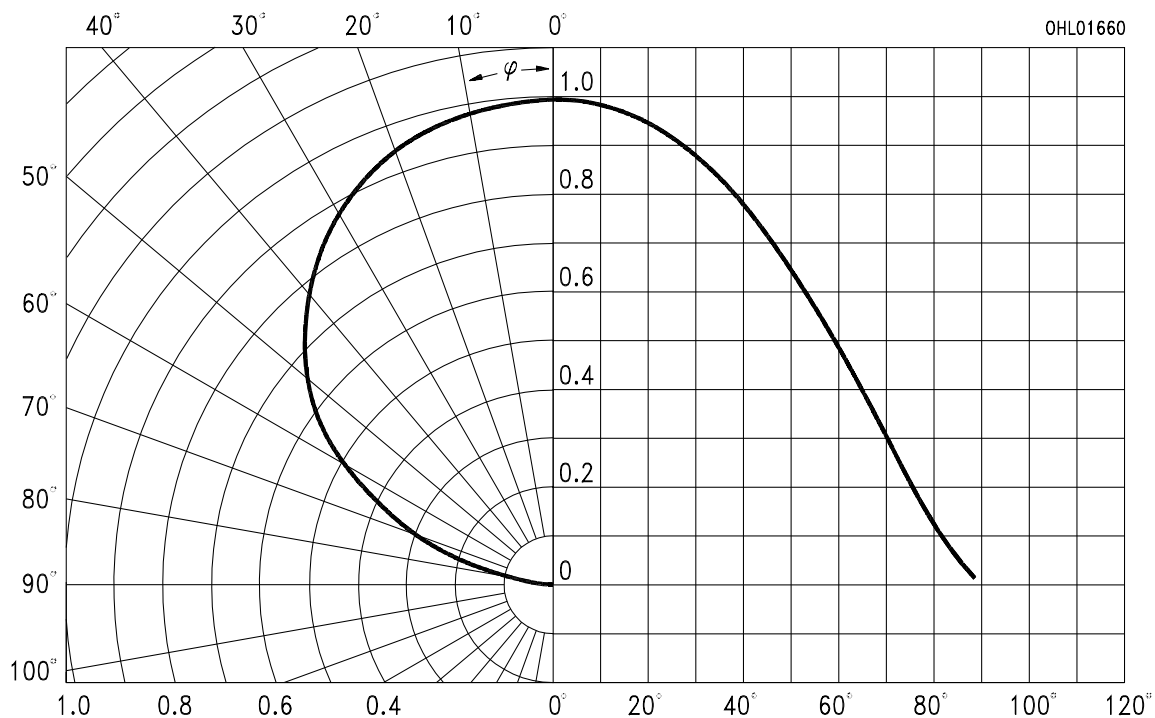

Durchlaßstrom $I_F = f(V_F)$

Forward current

$T_A = 25^\circ\text{C}$

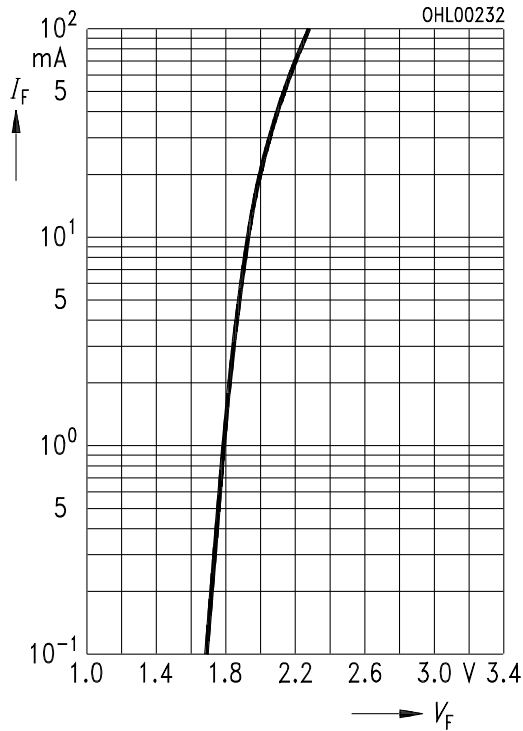

Relative Lichtstärke $I_V / I_{V(20\text{mA})} = f(I_F)$

Relative luminous intensity

$T_A = 25^\circ\text{C}$

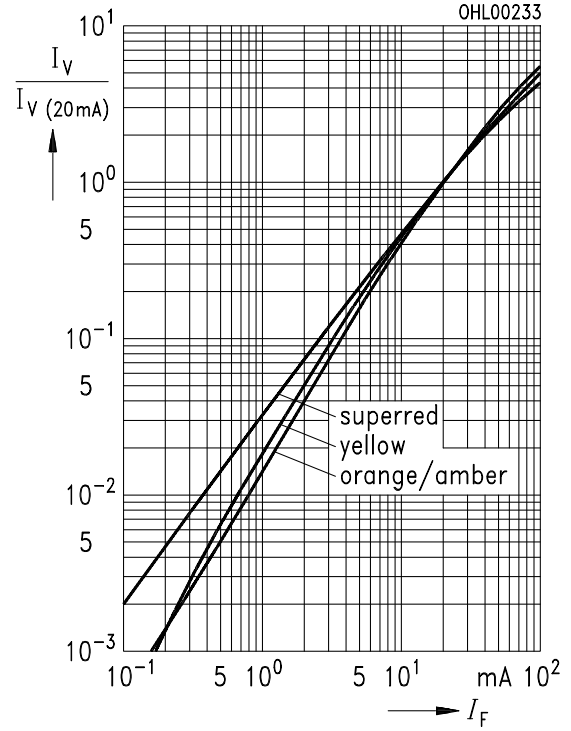

Maximal zulässiger Durchlaßstrom

Max. permissible forward current

$I_F = f(T_A)$

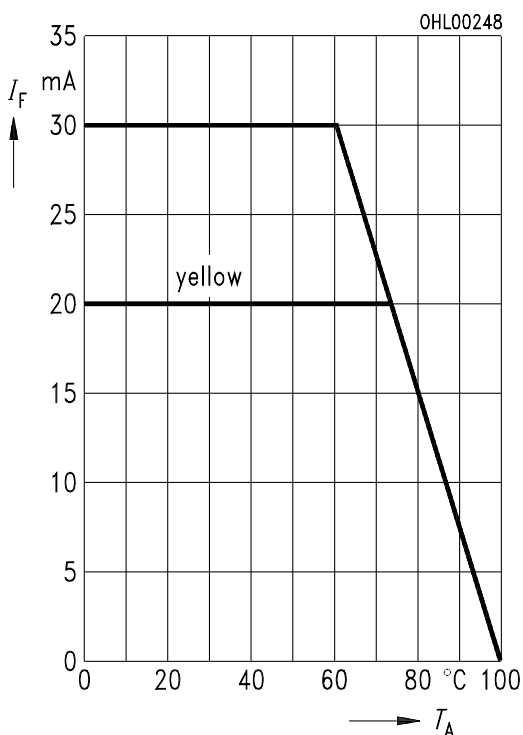

Relative Lichtstärke $I_V / I_{V(25^\circ\text{C})} = f(T_A)$

Relative luminous intensity

$I_F = 10\text{ mA}$

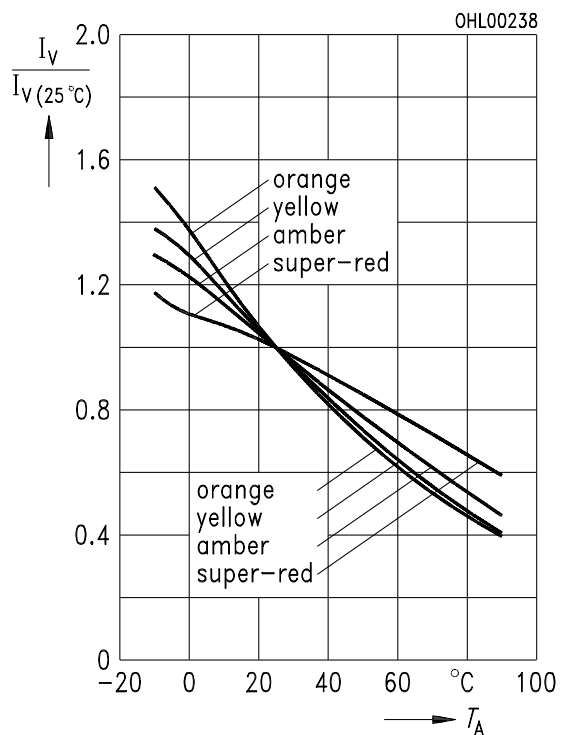

Zulässige Impulsbelastbarkeit $I_F = f(t_p)$
Permissible pulse handling capability
LS, LA, LO

Duty cycle $D =$ parameter, $T_A = 25\text{ °C}$

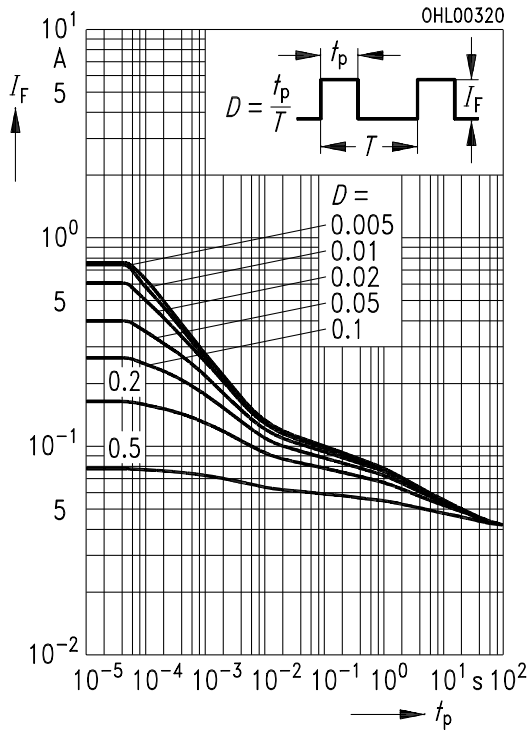

Zulässige Impulsbelastbarkeit $I_F = f(t_p)$
Permissible pulse handling capability
LY

Duty cycle $D =$ parameter, $T_A = 25\text{ °C}$

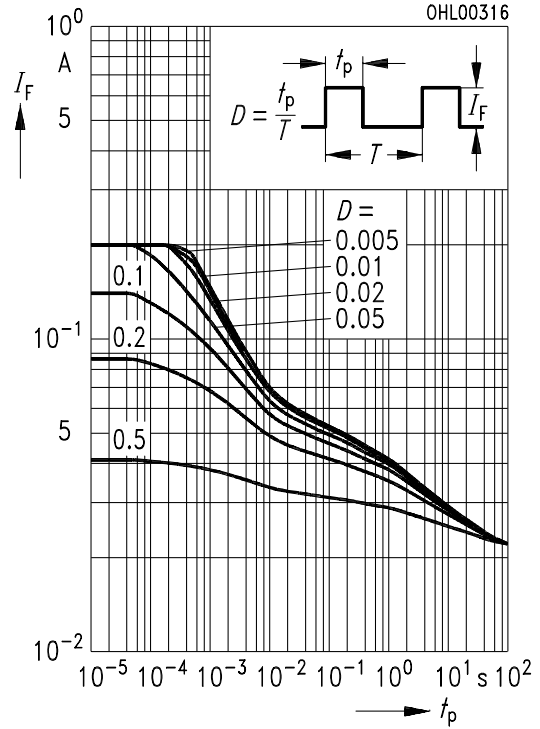

Maßzeichnung (Maße in mm, wenn nicht anders angegeben)
Package Outlines (Dimensions in mm, unless otherwise specified)

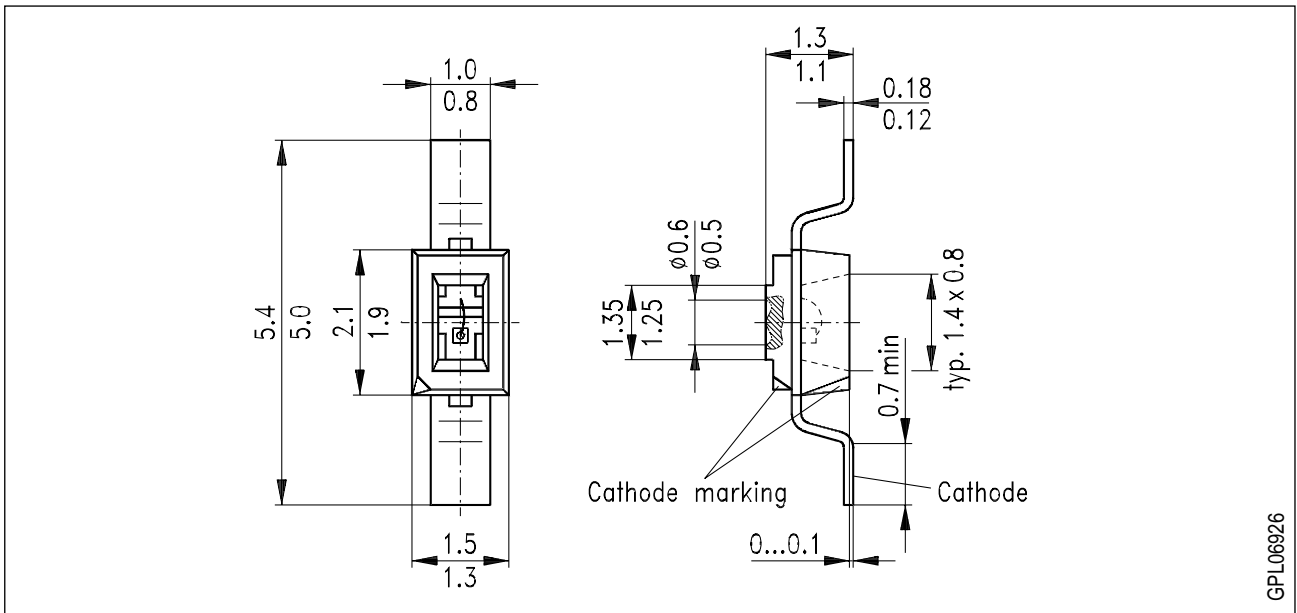

GPL06926

Kathodenkennung: abgeschrägte Ecke
Cathode mark: bevelled edge