

QSA156/157/158/159

PACKAGE DIMENSIONS

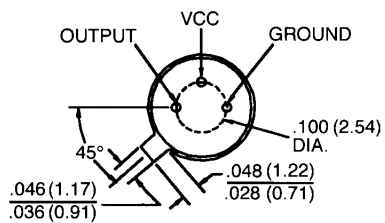
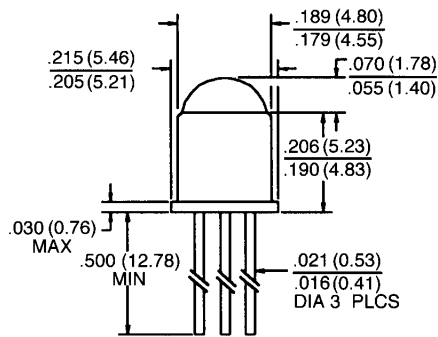

ST2139

DESCRIPTION

The QSA15X family are OPTOLOGIC™ ICs which feature a Schmitt trigger at output which provides hysteresis for noise immunity and pulse shaping. The basic building block of this IC consists of a photodiode, a linear amplifier, voltage regulator, Schmitt trigger and four output options. The TTL/LSTTL compatible output can drive up to ten TTL loads over supply currents from 4.5 to 16.0 volts. The monolithic die is packaged in a narrow angle, hermetically sealed, TO-18 metal can package.

FEATURES

- High noise immunity.
- Direct TTL/LSTTL interface.
- Hermetically sealed package.
- Reception angle of $\pm 12^\circ$.



OPTOLOGIC™

ABSOLUTE MAXIMUM RATINGS ($T_A = 25^\circ\text{C}$ Unless Otherwise Specified)	
Supply Voltage, V_{CC}	18 volts
Storage Temperature	-65°C to $+125^\circ\text{C}$
Operating Temperature	-55°C to $+105^\circ\text{C}$
Soldering:	
Lead Temperature (Iron)	240°C for 5 sec. ^(2,3,4,5)
Lead Temperature (Flow)	260°C for 10 sec. ^(2,3,5)
Power Dissipation	250 mW ⁽¹⁾
Duration of Output short to V_{CC}	1.00 sec.
Voltage at Output	35 volts
Sinking Current	50 mA
Sourcing Current (QSA156, QSA157)	10 mA
Irradiance	3.0 mW/cm^2

ELECTRICAL CHARACTERISTICS ($T_A = -40^\circ\text{C}$ to $+85^\circ\text{C}$) ($V_{CC} = 4.5$ to 16 volts)						
PARAMETER	SYMBOL	MIN.	TYP.	MAX.	UNITS	TEST CONDITIONS
Operating Supply Voltage	V_{CC}	4.5		16.0	V	
Positive Going Threshold Irradiance ⁽⁶⁾	Ee (+)	0.025		0.250	mW/cm^2	$T_A = 25^\circ\text{C}$
Hysteresis Ratio	Ee(+)/Ee(-)	1.10		2.00		
Supply Current	I_{CC}	—		12.0	mA	Ee = 0 or $.3 \text{ mW/cm}^2$ ⁽⁶⁾
Peak to peak ripple which will cause false triggering		—		2.00	V	f = DC to 50 MHz
QSA156 (BUFFER TOTEM POLE)						
High Level Output Voltage	V_{OH}	$V_{CC} - 2.1$		—	V	Ee = $.3 \text{ mW/cm}^2$, $I_{OH} = -1.0 \text{ mA}$ ⁽⁶⁾
Low Level Output Voltage	V_{OL}	—		0.40	V	Ee = 0, $I_{OL} = 16 \text{ mA}$
QSA157 (INVERTER TOTEM POLE)						
High Level Output Voltage	V_{OH}	$V_{CC} - 2.1$		—	V	Ee = 0, $I_{OH} = -1.0 \text{ mA}$
Low Level Output Voltage	V_{OL}	—		0.40	V	Ee = $.3 \text{ mW/cm}^2$, $I_{OL} = 16 \text{ mA}$ ⁽⁶⁾
QSA158 (BUFFER OPEN COLLECTOR)						
High Level Output Current	I_{OH}	—		100	μA	Ee = $.3 \text{ mW/cm}^2$, $V_{OH} = 30 \text{ V}$ ⁽⁶⁾
Low Level Output Voltage	V_{OL}	—		0.40	V	Ee = 0, $I_{OL} = 16 \text{ mA}$
QSA159 (INVERTER OPEN COLLECTOR)						
High Level Output Current	I_{OH}	—		100	μA	Ee = 0, $V_{OH} = 30 \text{ V}$
Low Level Output Voltage	V_{OL}	—		0.40	V	Ee = $.3 \text{ mW/cm}^2$, $I_{OL} = 16 \text{ mA}$ ⁽⁶⁾

ELECTRICAL CHARACTERISTICS ($T_A = -40^\circ\text{C}$ to $+85^\circ\text{C}$) ($V_{CC} = 4.5$ to 16 volts)						
PARAMETER	SYMBOL	MIN.	TYP.	MAX.	UNITS	TEST CONDITIONS
QSA156, QSA157						
Output rise, fall times	t_r, t_f	—		70	nS	$E_e = 0$ or $.3 \text{ mW/cm}^2$, $f = 10\text{K HZ}$
Propagation delay	t_{phl}, t_{plh}		6.0		μS	DC=50%, $R_L = 10 \text{ TTL loads}$
QSA158, QSA159						
Output rise, fall times	t_r, t_f	—		100	nS	$E_e = 0$ or $.3 \text{ mW/cm}^2$, $f = 10\text{K HZ}$
Propagation delay	t_{phl}, t_{plh}		6.0		μS	DC=50%, $R_L = 300\Omega^{(6)}$

Switching Test Curve For Buffers

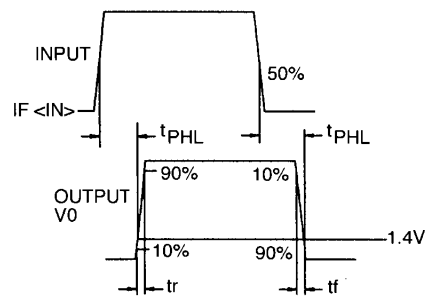

Switching Test Curve For Inverters

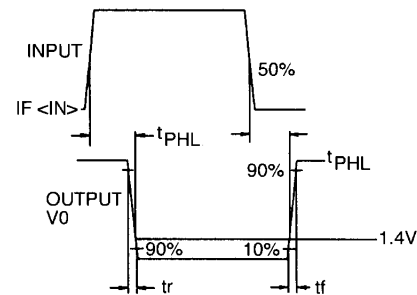

ST2141

NOTES

1. Derate power dissipation linearly $2.50 \text{ mW}/^\circ\text{C}$ above 25°C .
2. RMA flux is recommended.
3. Methanol or Isopropyl alcohols are recommended as cleaning agents.
4. Soldering iron tip $1/16"$ (1.6 mm) minimum from housing.
5. As long as leads are not under any stress or spring tension.
6. Irradiance measurements are made with an AlGaAs LED emitting light at a peak wavelength of 880 nm.

CIRCUIT SCHEMATICS

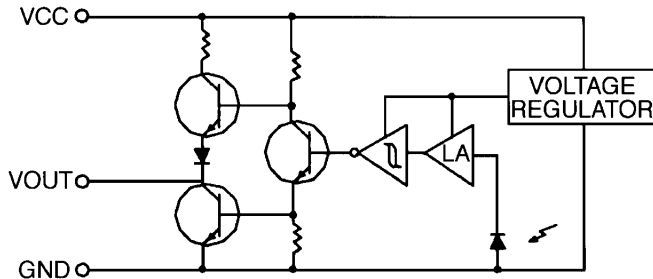

QSA156
Totem-Pole Output Buffer

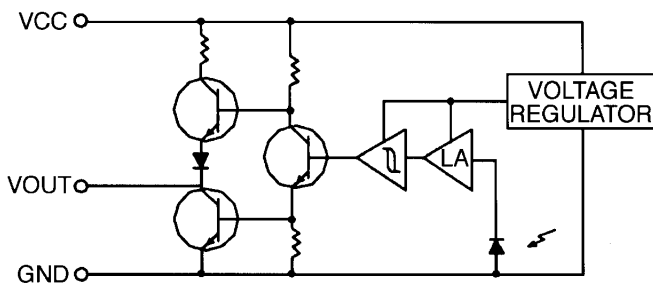

QSA157
Totem-Pole Output Inverter

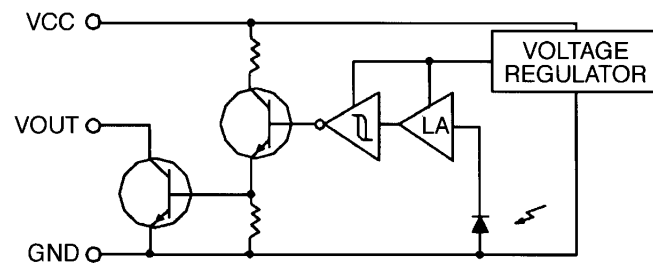

QSA158
Open-Collector Output Buffer

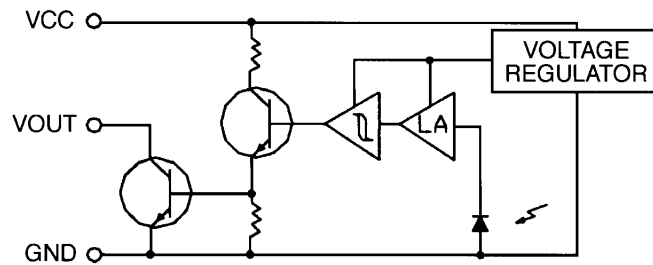

QSA159
Open-Collector Output Inverter

ST2140