

### Silicon RF Switching Diode

#### Preliminary data

- Design for use in shunt configuration
- High shunt signal isolation
- Low shunt insertion loss

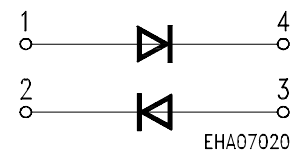
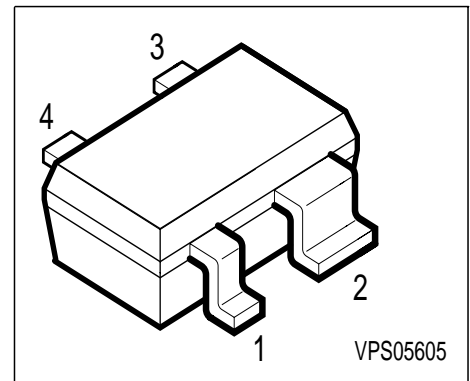

Type	Marking	Ordering Code	Pin Configuration				Package
BAR 81W	BBs	Q62702-A1270	1 = A1	2 = C2	3 = A2	4 = C1	SOT-343

#### Maximum Ratings

Parameter	Symbol	Value	Unit
Diode reverse voltage	$V_R$	30	V
Forward current	$I_F$	100	mA
Total power dissipation, $T_S = 138\text{ °C}$	$P_{tot}$	100	mW
Junction temperature	$T_j$	150	°C
Operating temperature range	$T_{op}$	-55 ... +125	°C
Storage temperature	$T_{stg}$	-55 ... +150	

#### Thermal Resistance

Junction - ambient <sup>1)</sup>	$R_{thJA}$	≤ 200	K/W
Junction - soldering point	$R_{thJS}$	≤ 120	

1) Package mounted on alumina 15mm x 16.7mm x 0.7mm

**Electrical Characteristics** at  $T_A = 25\text{ }^\circ\text{C}$ , unless otherwise specified.

Parameter	Symbol	Values			Unit
		min.	typ.	max.	
<b>Characteristics</b>					
Reverse current $V_R = 20\text{ V}$	$I_R$	-	-	20	nA
Forward voltage $I_F = 100\text{ mA}$	$V_F$	-	0.93	1	V
<b>AC characteristics</b>					
Diode capacitance $V_R = 1\text{ V}, f = 1\text{ MHz}$ $V_R = 3\text{ V}, f = 1\text{ MHz}$	$C_T$	-	0.6 0.57	-	pF
Forward resistance $I_F = 5\text{ mA}, f = 100\text{ MHz}$	$r_f$	-	0.7	-	$\Omega$
Series inductance	$L_s$	-	0.15	-	nH

### Configuration of the shunt-diode

- A perfect ground is essential for optimum isolation
- The anode pins should be used as passage for RF

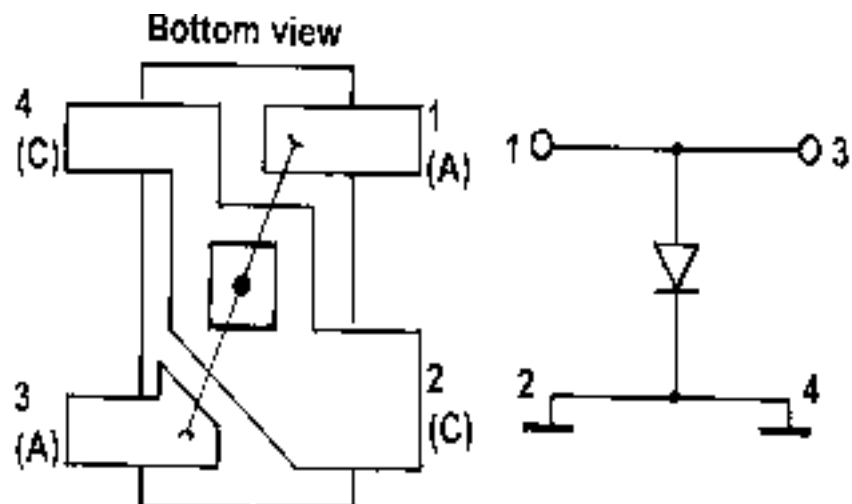

### Forward current $I_F = f(T_A^*; T_S)$

\*) : mounted on alumina 15mm x 16.7mm x 0.7mm

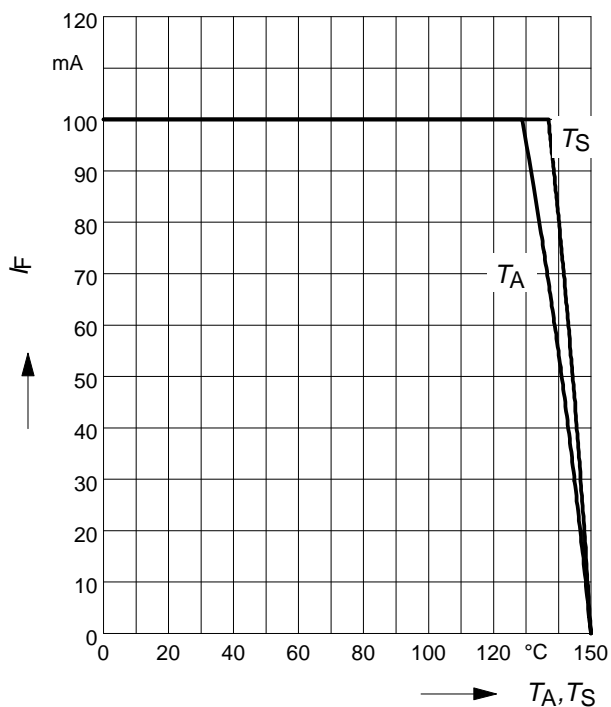

### Permissible Pulse Load $R_{thJS} = f(t_p)$

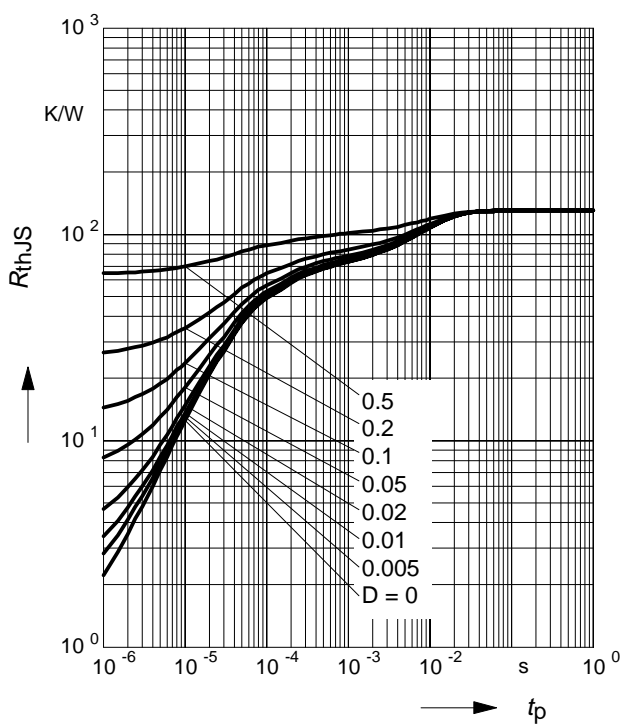

### Permissible Pulse Load

$$I_{Fmax} / I_{FDC} = f(t_p)$$

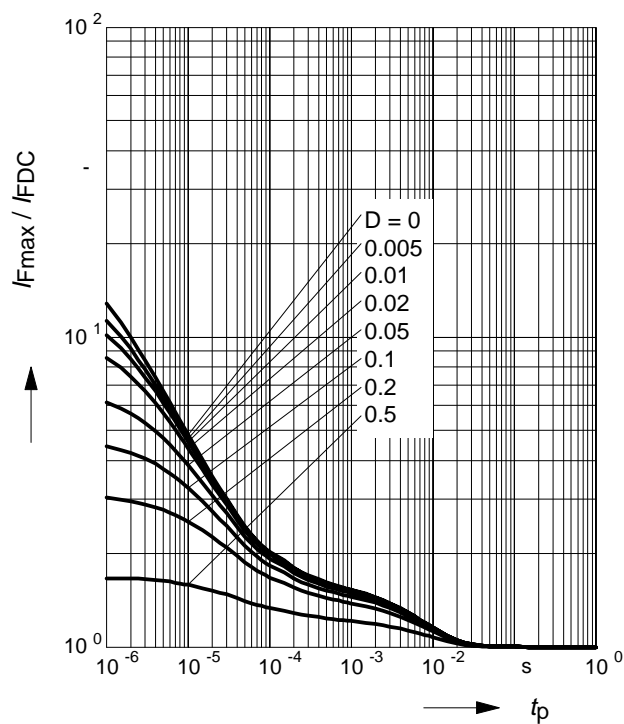

**Forward current  $I_F = f(V_F)$**

$T_A = 25^\circ\text{C}$

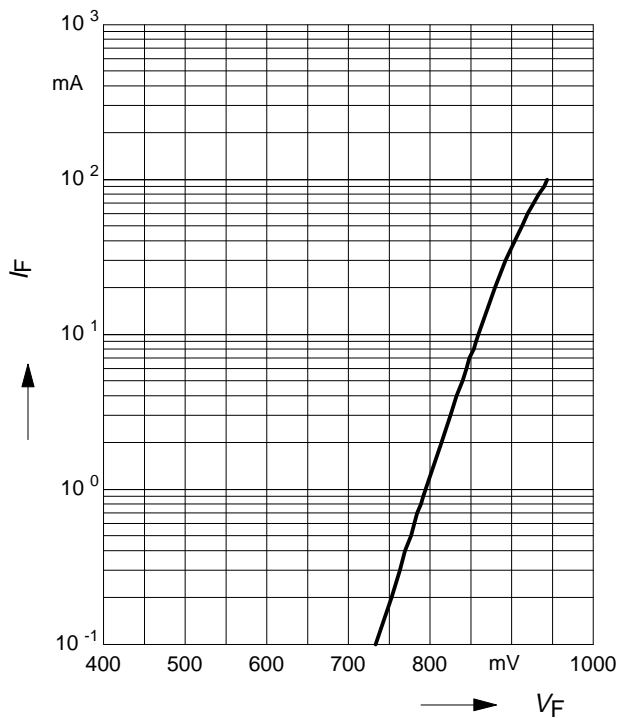

**Forward resistance  $r_f = f(I_F)$**

$f = 100\text{MHz}$

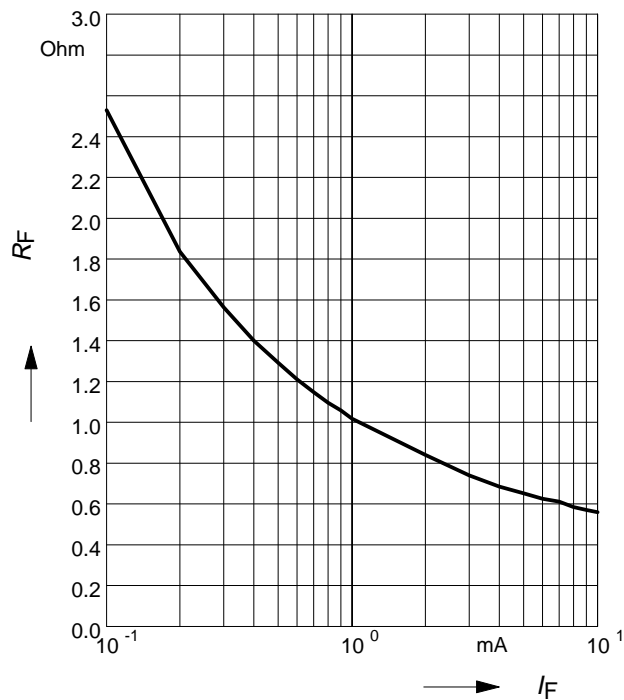

**Diode capacitance  $C_T = f(V_R)$**

$f = 1\text{MHz}$

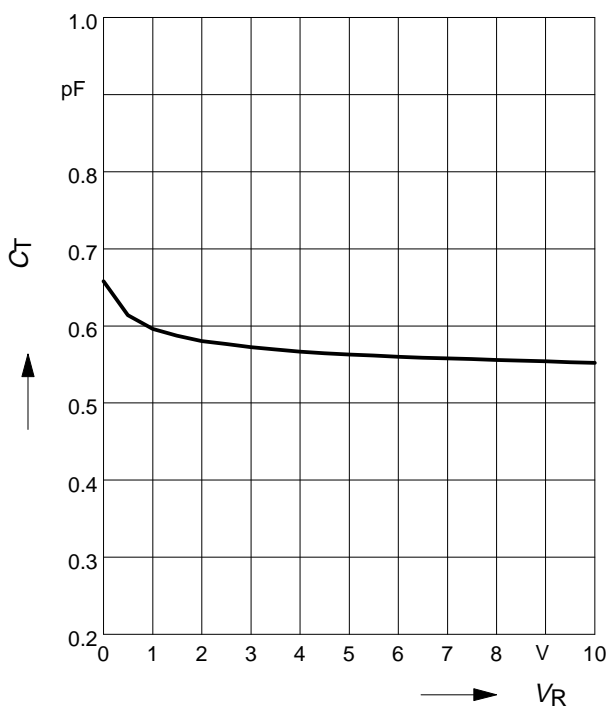

**Diode capacitance  $C_T = f(V_R)$**

$f = 100\text{MHz}$

