

# KA5Q0565RT

## Fairchild Power Switch(FPS)

### Features

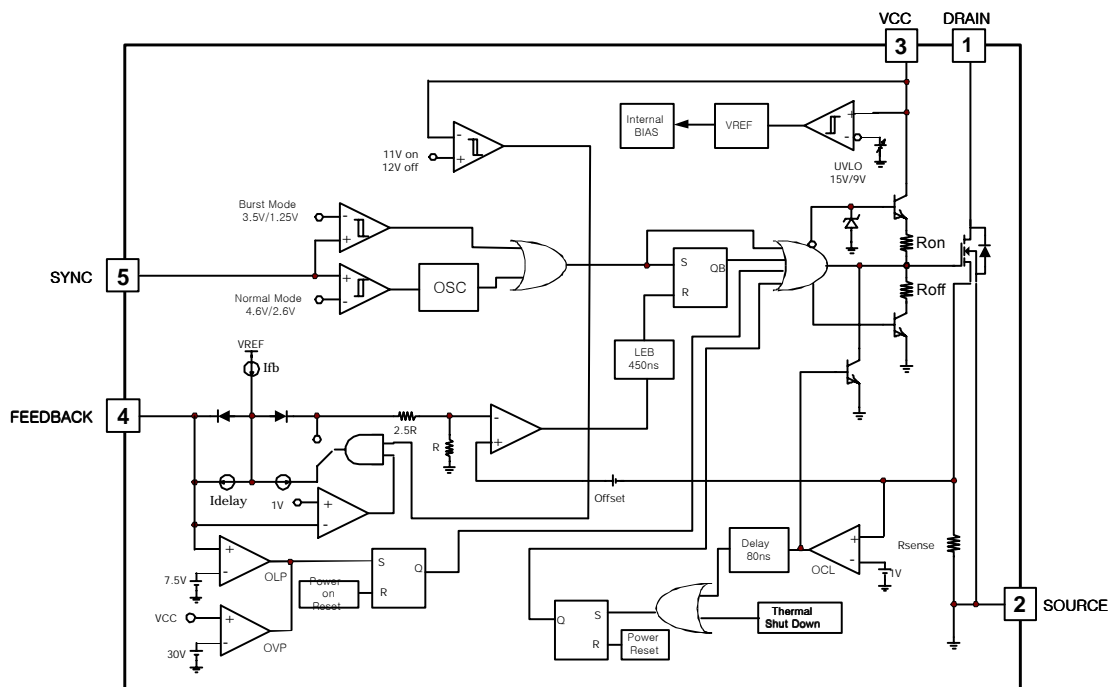
- Quasi Resonant Converter Controller
- Internal Burst Mode Controller for Stand-by Mode
- Pulse by Pulse Current Limiting
- Over Current Latch Protection
- Over Voltage Protection (Vcc: Min. 27V)
- Internal Thermal Shutdown Function
- Under Voltage Lockout
- Internal High Voltage Sense FET
- Auto-Restart Mode

### Description

The Fairchild Power Switch(FPS) product family is specially designed for an off-line SMPS with minimal external components. The Fairchild Power Switch(FPS) consists of a high voltage power SenseFET and a current mode PWM IC. The integrated PWM controller includes the fixed oscillator, the under voltage lock out, the leading edge blanking, the optimized gate turn-on/turn-off driver, the thermal shut down protection, the over voltage protection, and the temperature compensated precision current sources for loop compensation and fault protection circuitry. Compared to a discrete MOSFET and a controller or a RCC switching converter solutions, a Fairchild Power Switch(FPS) can reduce the total number of components, design size, and weight, so it will improve efficiency, productivity, and system reliability. It has a basic platform well suited for cost-effective design in a quasi-resonant converter as a C-TV power supply.



### Internal Block Diagram



## Absolute Maximum Ratings

(Ta=25°C, unless otherwise specified)

Parameter	Symbol	Value	Unit
Drain-source Voltage	V <sub>DSS</sub>	650	V
Drain-Gate Voltage (R <sub>GS</sub> =1MΩ)	V <sub>DGR</sub>	650	V
Gate-Source (GND) Voltage	V <sub>GS</sub>	±30	V
Drain Current Pulsed <sup>(2)</sup>	I <sub>DM</sub>	11	ADC
Single Pulsed Avalanch Current <sup>(3)</sup> (Energy <sup>(2)</sup> )	I <sub>AS</sub> (EAS)	13(400)	A(mJ)
Continuous Drain Current (T <sub>c</sub> = 25°C)	I <sub>D</sub>	2.8	ADC
Continuous Drain Current (T <sub>C</sub> =100°C)	I <sub>D</sub>	1.7	ADC
Supply Voltage	V <sub>CC</sub>	30	V
Input Voltage Range	V <sub>FB</sub>	-0.3 to V <sub>cc</sub>	V
Total Power Dissipation	P <sub>D</sub>	38	W
	Derating	0.3	W/°C
Operating Junction Temperature	T <sub>J</sub>	+160	°C
Operating Ambient Temperature	T <sub>A</sub>	-25 to +85	°C
Storage Temperature Range	T <sub>STG</sub>	-55 to +150	°C
Thermal Resistance	R <sub>thjc</sub>	3.29	°C/W
ESD Capability, HBM Model (All pins)	-	2.0	kV
ESD Capability, Machine Model (All pins)	-	300	V

### Notes:

1. T<sub>j</sub> = 25°C to 150°C
2. Repetitive rating: Pulse width limited by maximum junction temperature
3. L = 30mH, V<sub>DD</sub> = 50V, R<sub>G</sub> = 25Ω, starting T<sub>j</sub> = 25°C
4. L = 13uH, starting T<sub>j</sub> = 25°C

## Electrical Characteristics (SFET Part)

(Ta=25°C unless otherwise specified)

Parameter	Symbol	Condition	Min.	Typ.	Max.	Unit
Drain-Source Breakdown Voltage	BV <sub>DSS</sub>	V <sub>GS</sub> = 0V, I <sub>D</sub> = 50μA	650	-	-	V
Zero Gate Voltage Drain Current	I <sub>DSS</sub>	V <sub>DS</sub> = Max, Rating, V <sub>GS</sub> = 0V	-	-	200	μA
		V <sub>DS</sub> = 0.8*Max., Rating V <sub>GS</sub> = 0V, T <sub>C</sub> = 85°C	-	-	300	μA
Static Drain-source on Resistance <sup>(Note)</sup>	R <sub>DS(ON)</sub>	V <sub>GS</sub> = 10V, I <sub>D</sub> = 2.3A	-	1.8	2.2	Ω
Input Capacitance	C <sub>iss</sub>	V <sub>GS</sub> = 0V, V <sub>DS</sub> = 25V, f = 1MHz	-	780	-	pF
Output Capacitance	C <sub>oss</sub>		-	90	-	
Reverse Transfer Capacitance	C <sub>rss</sub>		-	40	-	
Turn on Delay Time	t <sub>d(on)</sub>	V <sub>DD</sub> = 0.5BV <sub>DSS</sub> , I <sub>D</sub> = 7.0A (MOSFET switching time are essentially independent of operating temperature)	-	15	40	nS
Rise Time	t <sub>r</sub>		-	45	100	
Turn Off Delay Time	t <sub>d(off)</sub>		-	60	130	
Fall Time	t <sub>f</sub>		-	40	90	
Total Gate Charge (Gate-Source+Gate-Drain)	Q <sub>g</sub>	V <sub>GS</sub> = 10V, I <sub>D</sub> = 7.0A, V <sub>DS</sub> = 0.5B V <sub>DSS</sub> (MOSFET Switching time are Essentially independent of operating temperature)	-	43	55	nC
Gate-Source Charge	Q <sub>gs</sub>		-	4.0	-	
Gate-Drain (Miller) Charge	Q <sub>gd</sub>		-	7.3	-	

### Note:

1. Pulse test : Pulse width ≤ 300μS, duty ≤ 2%

**Electrical Characteristics** (Continued)

(Ta=25°C unless otherwise specified)

Parameter	Symbol	Condition	Min.	Typ.	Max.	Unit
<b>UVLO SECTION</b>						
Start Threshold Voltage	VSTART	VFB = GND	14	15	16	V
Stop Threshold Voltage	VSTOP	VFB = GND	8	9	10	V
<b>OSCILLATOR SECTION</b>						
Initial Frequency	FOSC	-	18	20	22	kHz
Voltage Stability	FSTABLE	12V ≤ Vcc ≤ 23V	0	1	3	%
Temperature Stability (Note2)	ΔFOSC	-25°C ≤ Ta ≤ 85°C	0	±5	±10	%
Maximum Duty Cycle	DMAX	-	92	95	98	%
Minimum Duty Cycle	DMIN	-	-	-	0	%
<b>FEEDBACK SECTION</b>						
Feedback Source Current	IFB	VFB = GND	0.7	0.9	1.1	mA
Shutdown Feedback Voltage	VSD	Vfb ≥ 6.9V	6.9	7.5	8.1	V
Shutdown Delay Current	IDELAY	VFB = 5V	4	5	6	μA
<b>PROTECTION SECTION</b>						
Over Voltage Protection	VCCOVP	VCC ≥ 26V	27	30	33	V
Over Current Latch Voltage (Note2)	VOCL	-	0.9	1.0	1.1	V
Thermal Shutdown Temp.	TSD	-	140	160	-	°C
<b>SYNC SECTION</b>						
Normal Sync High Threshold Voltage	VNSH	VCC = 16V, Vfb = 5V	4.0	4.6	5.2	V
Normal Sync Low Threshold Voltage	VNSL	VCC = 16V, Vfb = 5V	2.3	2.6	2.9	V
Burst Sync High Threshold Voltage	VBSH	VCC = 10.5V, Vfb = 0V	3.2	3.6	4.0	V
Burst Sync Low Threshold Voltage	VBSL	VCC = 10.5V, Vfb = 0V	1.1	1.3	1.5	V

**Note:**

1. These parameters is the current flowing in the Control IC.
2. These parameters, although guaranteed, are tested in EDS(wafer test) process.
3. These parameters indicate Inductor Current.

**Electrical Characteristics** (Continued)

(Ta=25°C unless otherwise specified)

Parameter	Symbol	Condition	Min.	Typ.	Max.	Unit
<b>BURST MODE SECTION</b>						
Burst Mode Low Threshold Voltage	VBURL	Vfb = 0V	10.4	11.0	11.6	V
Burst Mode High Threshold Voltage	VBURH	Vfb = 0V	11.4	12.0	12.6	V
Burst Mode Enable Feedback Voltage	VBEN	Vcc = 10.5V	0.7	1.0	1.3	V
Burst Mode Peak Current Limit	IBU_PK	Vcc = 10.5V	0.65	0.85	1.1	A
<b>CURRENT LIMIT(SELF-PROTECTION)SECTION</b>						
Peak Current Limit(Note3)	IPK	-	3.08	3.5	3.92	A
<b>TOTAL DEVICE SECTION</b>						
Start Up Current	I <sub>START</sub>	Vfb = GND, V <sub>CC</sub> = 14V	-	0.1	0.2	mA
Operating Supply Current (Note1)	I <sub>OP</sub>	Vfb = GND, V <sub>CC</sub> = 16V	-	10	18	mA
	I <sub>OP(MIN)</sub>	Vfb = GND, V <sub>CC</sub> = 10V				
	I <sub>OP(MAX)</sub>	Vfb = GND, V <sub>CC</sub> = 28V				

**Note:**

1. These parameters is the current flowing in the Control IC.
2. These parameters, although guaranteed, are tested in EDS(wafer test) process.
3. These parameters indicate Inductor Current.

## Typical Performance Characteristics

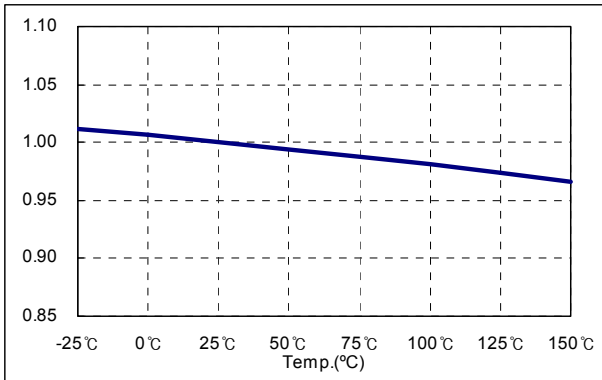


Figure 1. Start Voltage

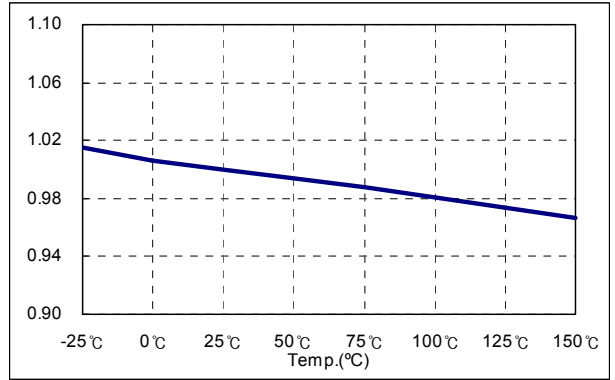


Figure 2. Stop Voltage

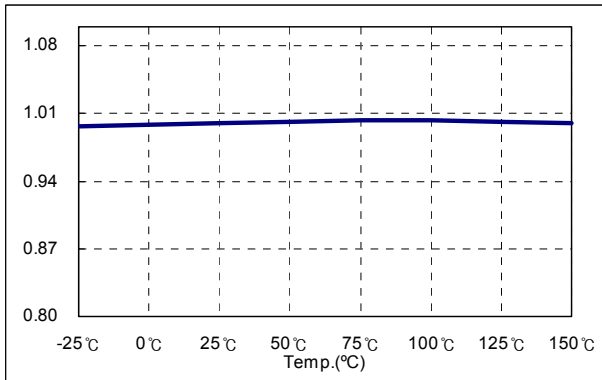


Figure 3. Stand by Current

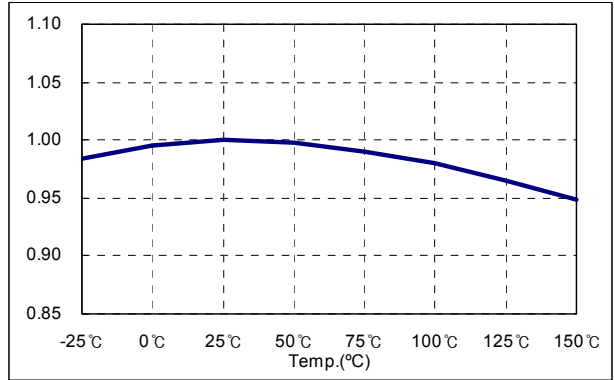


Figure 4. Operating Current

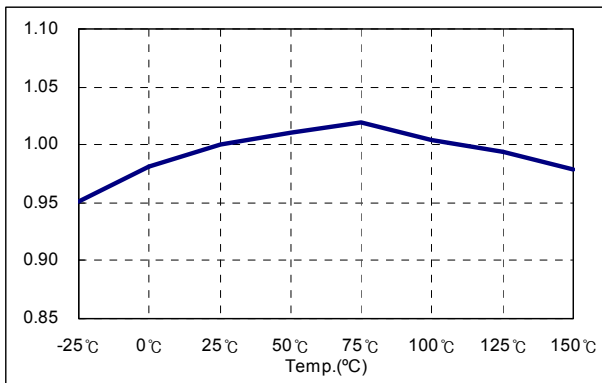


Figure 5. Initial Frequency

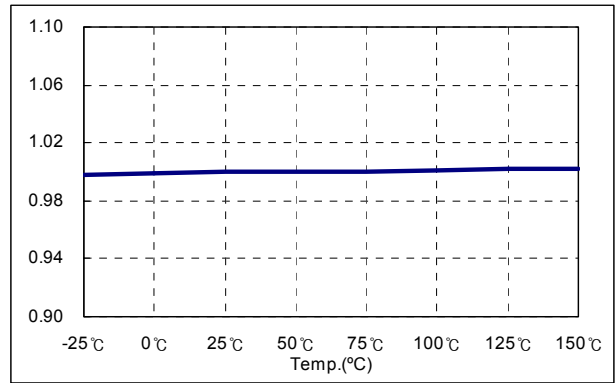
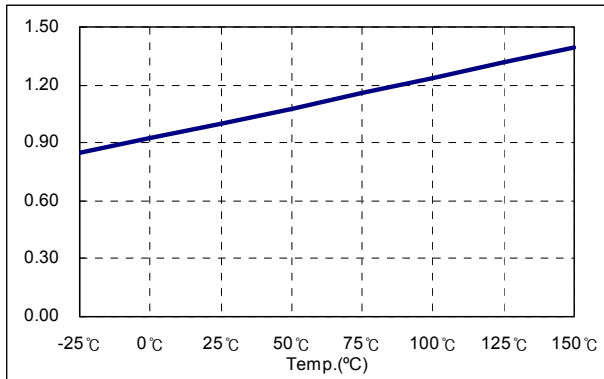
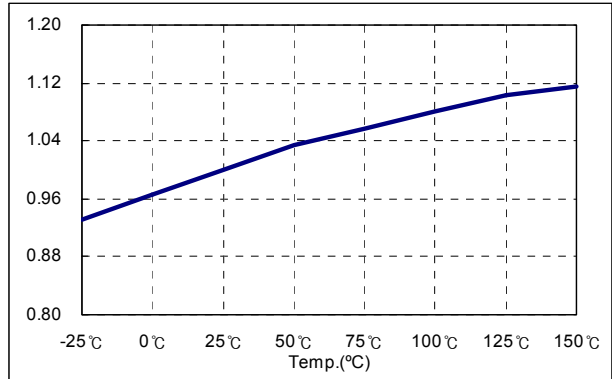


Figure 6. Maximum Duty

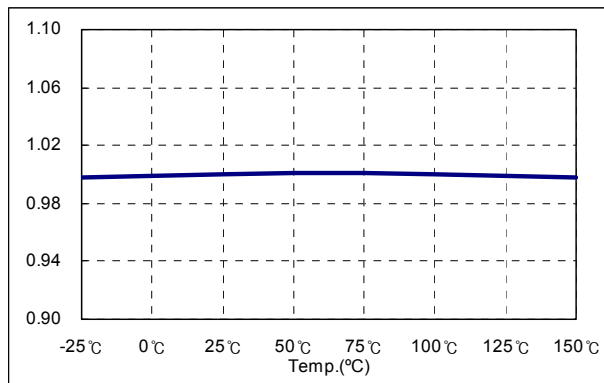
**Typical Performance Characteristics** (Continued)



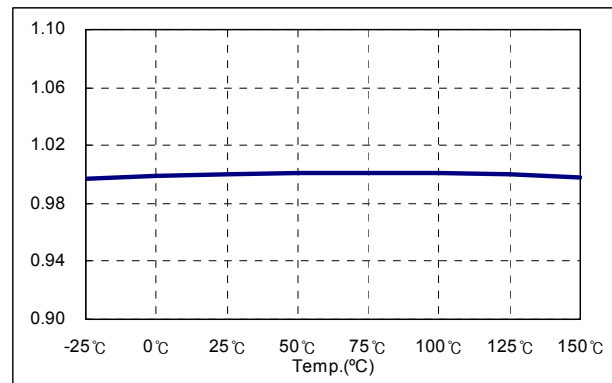
**Figure 7. Feedback Offset Voltage**



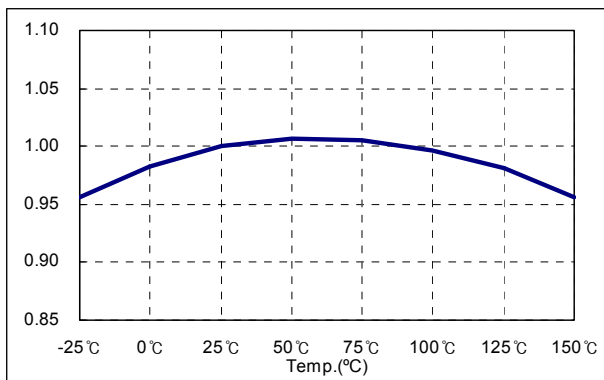
**Figure 8. Feedback Source Current**



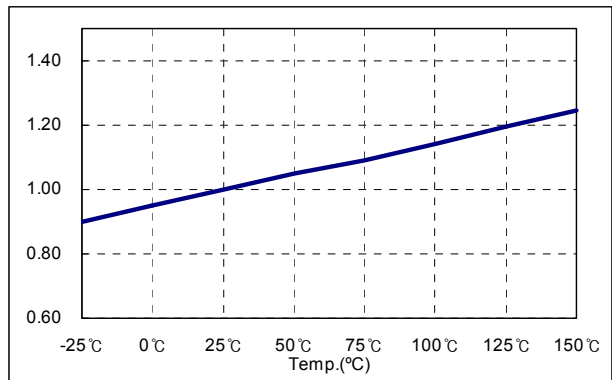
**Figure 9. Over Voltage Protection**



**Figure 10. Shutdown Feedback Voltage**

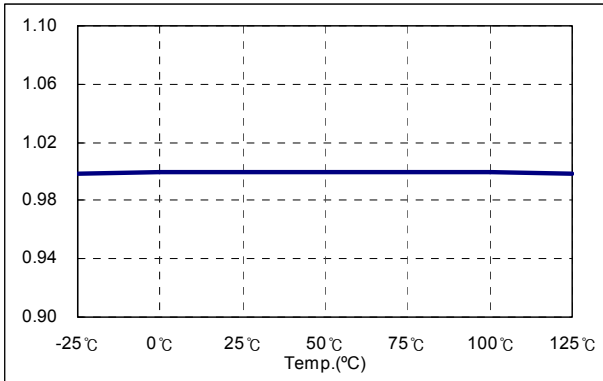


**Figure 11. ShutDown Delay Current**

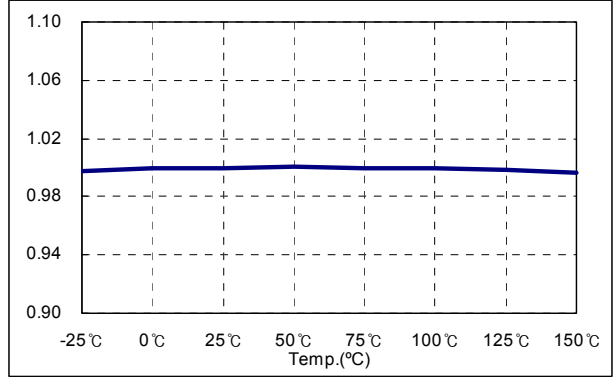


**Figure 12. Burst Mode Enable Feedback Voltage**

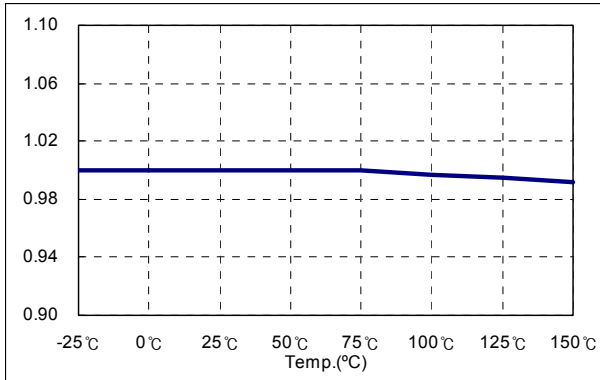
**Typical Performance Characteristics** (Continued)



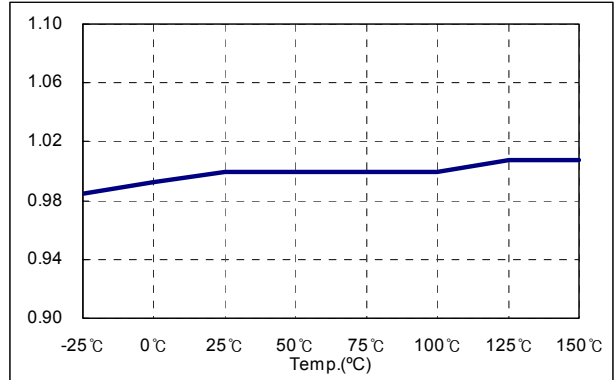
**Figure 13. Burst Mode Low Threshold Voltage**



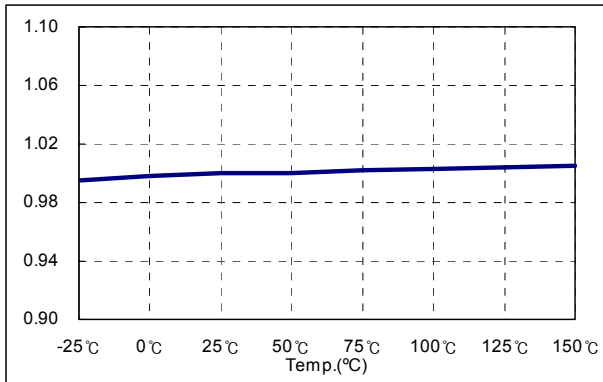
**Figure 14. Burst Mode High Threshold Voltage**



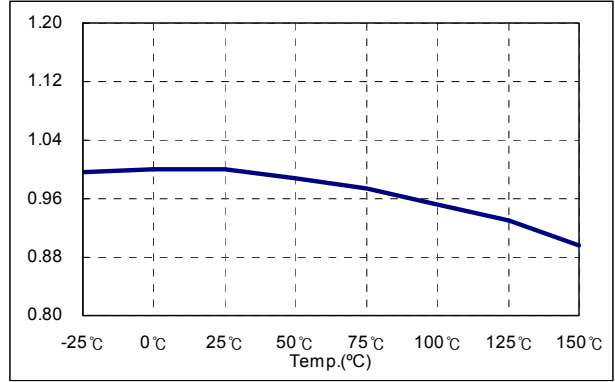
**Figure 15. Burst Mode Sync. High Threshold Voltage**



**Figure 16. Burst Mode Sync. Low Threshold Voltage**



**Figure 17. Primary Voltage**



**Figure 18. Primary Mode Gain**



## Typical Performance Characteristics (Continued)

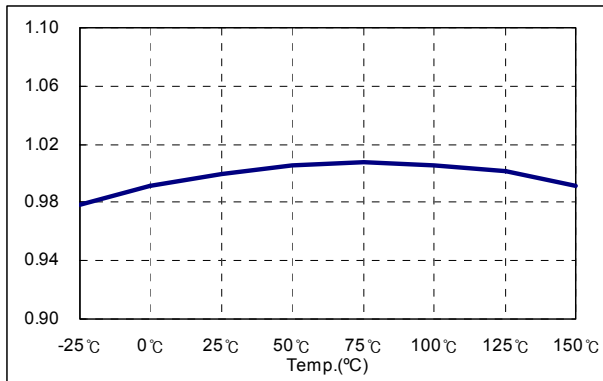


Figure 19. Peak Current Limit

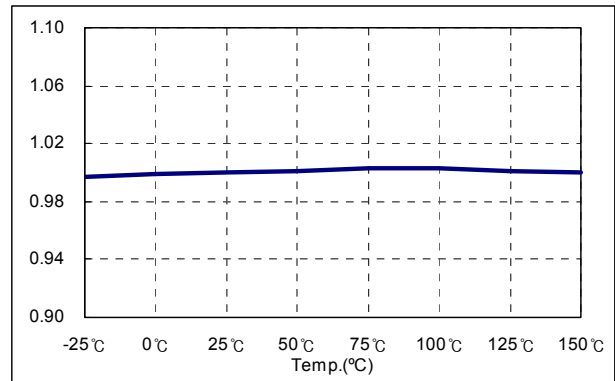


Figure 20. Burst Mode Peak Current Limit

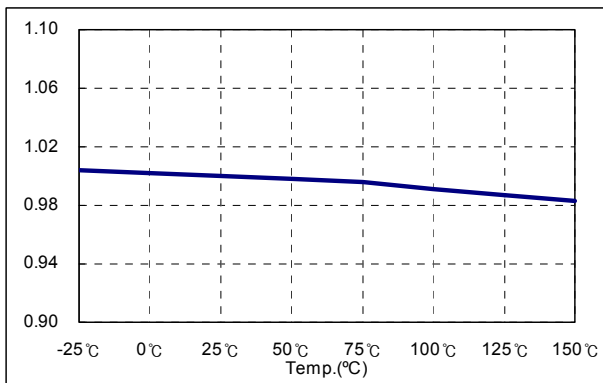


Figure 21. Normal Mode Sync. High Threshold Voltage

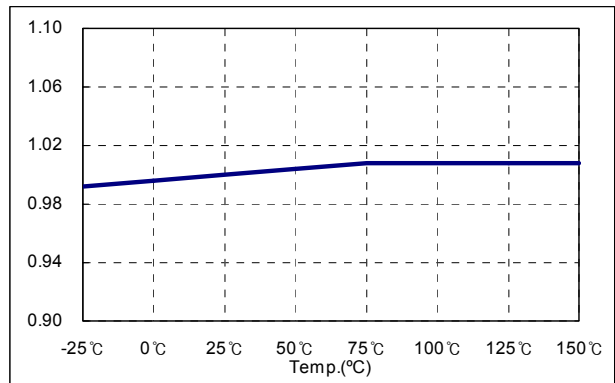


Figure 21. Normal Mode Sync. Low Threshold Voltage

## Typical Performance Characteristics (MOSFET Part)

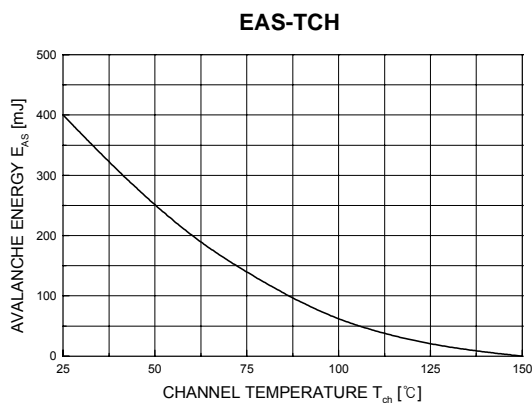


Figure 22. Temperature (T<sub>C</sub>) vs. Eas Curve

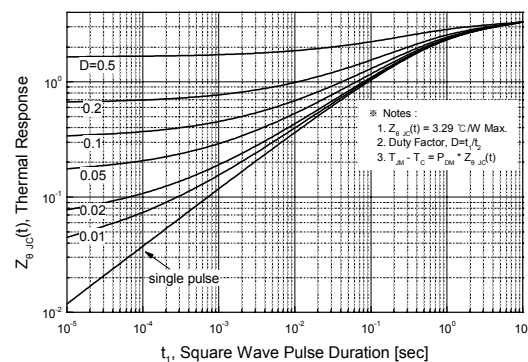
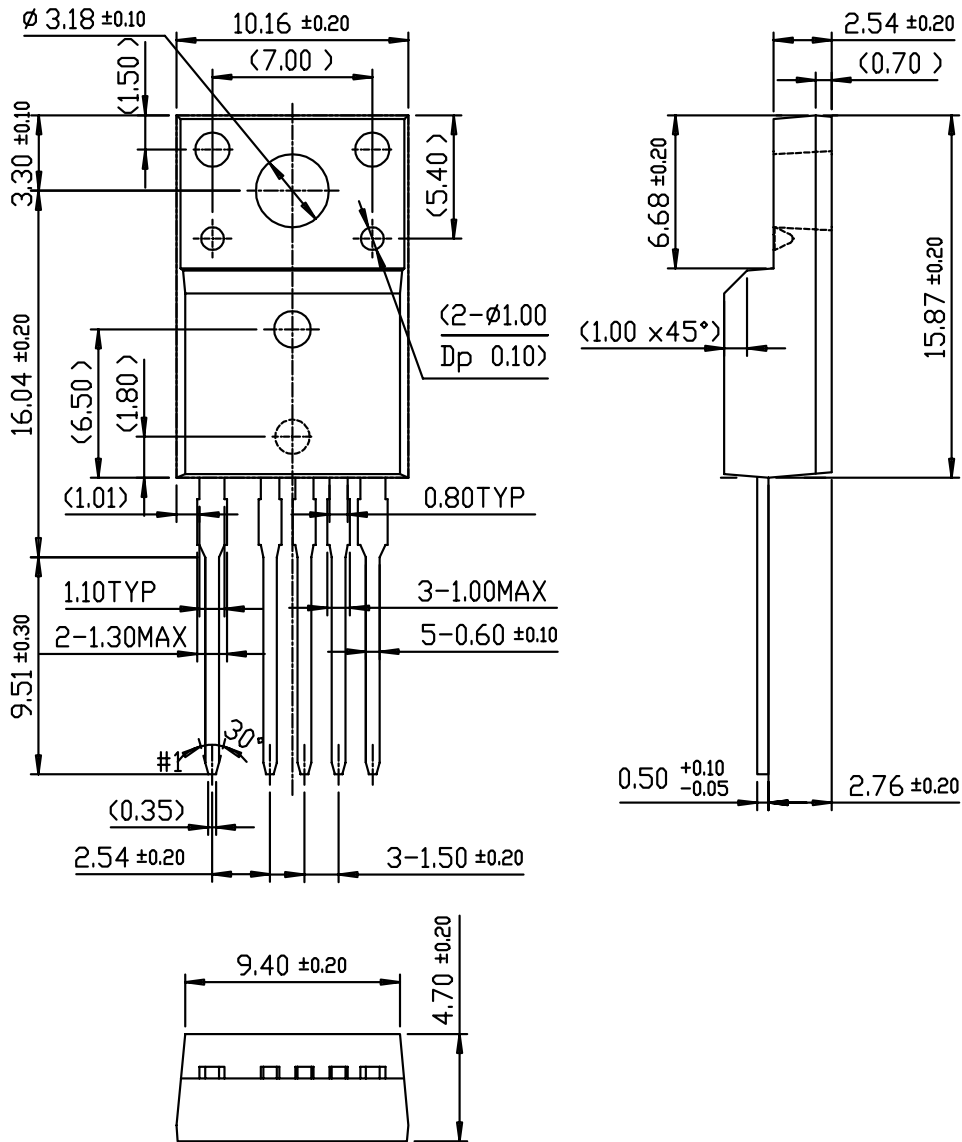


Figure 23. Transient Thermal Response Curve

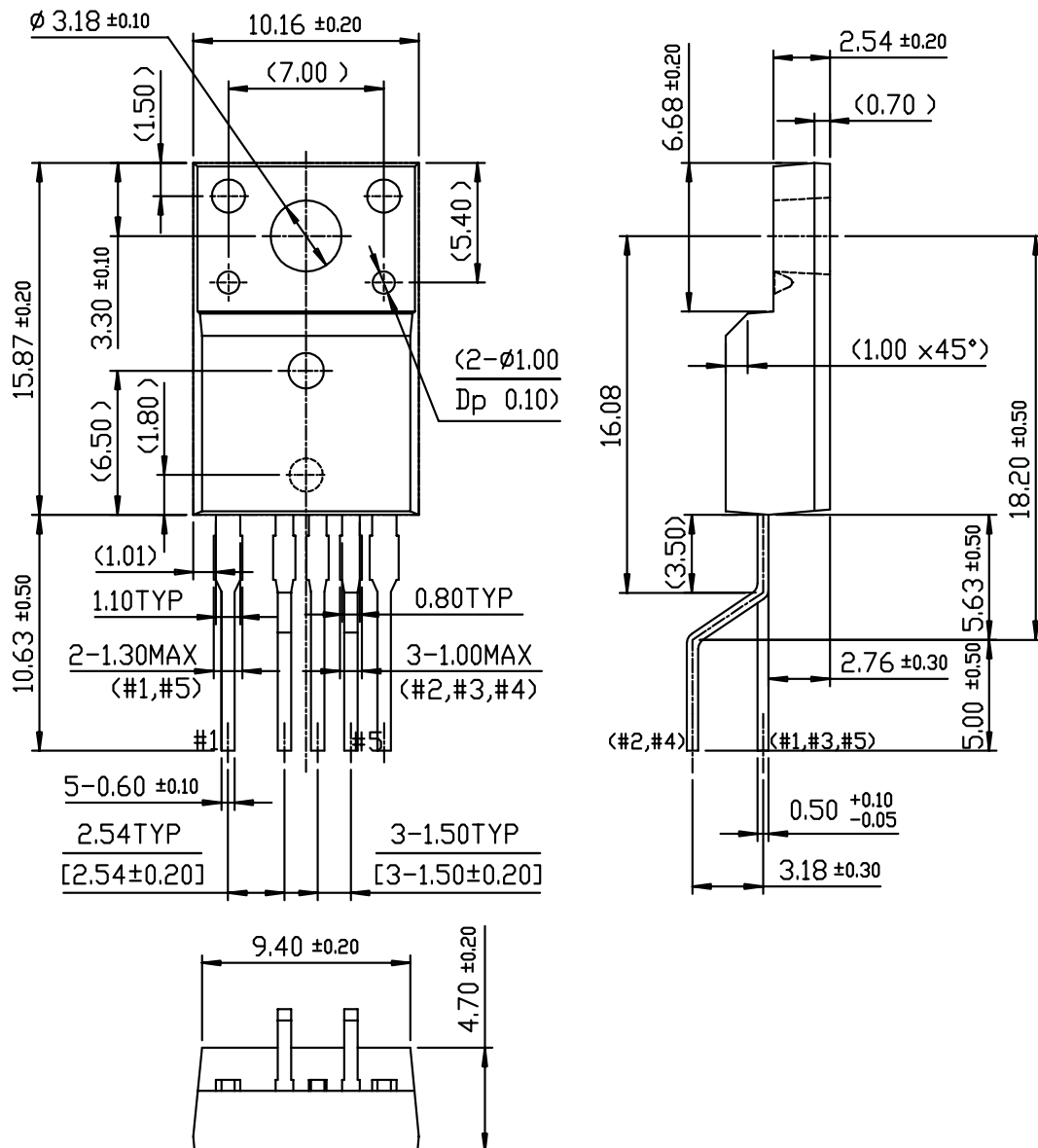
Package Dimensions

TO-220F-5L



## Package Dimensions (Continued)

## TO-220F-5L(Forming)



---

## Ordering Information

Product Number	Package	Operating Temp.
KA5Q0565RTTU	TO-220F-5L	-25°C to +85°C
KA5Q0565RTYDTU	TO-220F-5L(Forming)	

TU : Non Forming Type

YDTU : Forming Type

### DISCLAIMER

FAIRCHILD SEMICONDUCTOR RESERVES THE RIGHT TO MAKE CHANGES WITHOUT FURTHER NOTICE TO ANY PRODUCTS HEREIN TO IMPROVE RELIABILITY, FUNCTION OR DESIGN. FAIRCHILD DOES NOT ASSUME ANY LIABILITY ARISING OUT OF THE APPLICATION OR USE OF ANY PRODUCT OR CIRCUIT DESCRIBED HEREIN; NEITHER DOES IT CONVEY ANY LICENSE UNDER ITS PATENT RIGHTS, NOR THE RIGHTS OF OTHERS.

### LIFE SUPPORT POLICY

FAIRCHILD'S PRODUCTS ARE NOT AUTHORIZED FOR USE AS CRITICAL COMPONENTS IN LIFE SUPPORT DEVICES OR SYSTEMS WITHOUT THE EXPRESS WRITTEN APPROVAL OF THE PRESIDENT OF FAIRCHILD SEMICONDUCTOR CORPORATION. As used herein:

1. Life support devices or systems are devices or systems which, (a) are intended for surgical implant into the body, or (b) support or sustain life, and (c) whose failure to perform when properly used in accordance with instructions for use provided in the labeling, can be reasonably expected to result in a significant injury of the user.
2. A critical component in any component of a life support device or system whose failure to perform can be reasonably expected to cause the failure of the life support device or system, or to affect its safety or effectiveness.