



ULTRA-FAST RECOVERY RECTIFIER DIODES

MAIN PRODUCTS CHARACTERISTICS

$I_{F(AV)}$	5 A
V_{RRM}	200 V
$T_j(\text{max})$	150°C
$V_F(\text{max})$	0.99 V
$t_{rr}(\text{max})$	30 ns

FEATURES

- SUITED FOR SMPS
- LOW LOSSES
- LOW FORWARD AND REVERSE RECOVERY TIME
- HIGH SURGE CURRENT CAPABILITY
- HIGH AVALANCHE ENERGY CAPABILITY

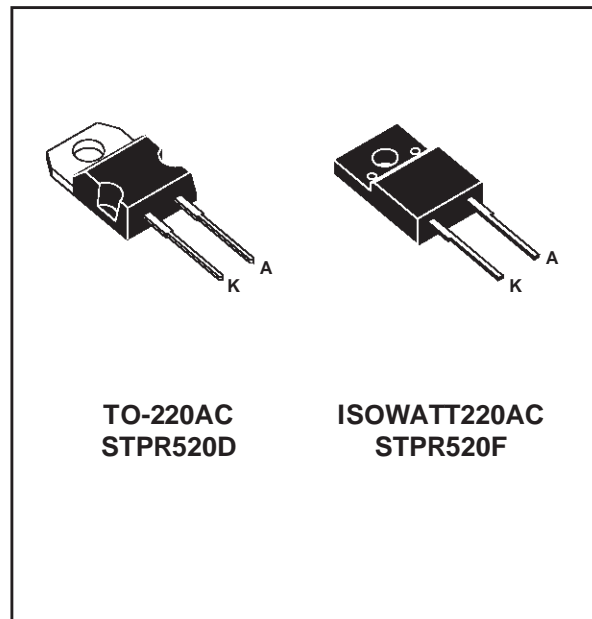

Low cost single chip rectifier suited for switchmode power supply and high frequency DC to DC converters.

Packaged in TO-220AC and ISOWATT220AC, this device is intended for use in low voltage, high frequency inverters, free wheeling and polarity protection applications.

Symbol	Parameter		Value	Unit
V_{RRM}	Repetitive peak reverse voltage		200	V
$I_{F(RMS)}$	RMS forward current		10	A
$I_{F(AV)}$	Average forward current $\delta = 0.5$	TO-220AC	5	A
		ISOWATT220AC		
I_{FSM}	Surge non repetitive forward current		50	A
		$T_p = 10\text{ ms}$ Sinusoidal		
T_{stg}	Storage temperature range		- 65 to + 150	°C
T_j	Maximum operating junction temperature		+ 150	

STPR520D/F

THERMAL RESISTANCES

Symbol	Parameter		Value	Unit
$R_{th(j-c)}$	Junction to case	TO-220AC	4	°C/W
		ISOWATT220AC	6	

STATIC ELECTRICAL CHARACTERISTICS

Symbol	Parameters	Test conditions		Min.	Typ.	Max.	Unit
I_R^*	Reverse leakage current	$T_j = 25^\circ\text{C}$	$V_R = V_{RRM}$			50	μA
		$T_j = 100^\circ\text{C}$				0.5	mA
V_F^{**}	Forward voltage drop	$T_j = 125^\circ\text{C}$	$I_F = 5\text{ A}$			0.99	V
		$T_j = 125^\circ\text{C}$	$I_F = 10\text{ A}$			1.20	
		$T_j = 25^\circ\text{C}$	$I_F = 10\text{ A}$			1.25	

Pulse test : * $t_p = 5\text{ ms}$, $\delta < 2\%$

** $t_p = 380\text{ }\mu\text{s}$, $\delta < 2\%$

To evaluate the conduction losses use the following equation :

$$P = 0.78 \times I_{F(AV)} + 0.042 \times I_{F(RMS)}^2$$

RECOVERY CHARACTERISTICS

Symbol	Test conditions			Min.	Typ.	Max.	Unit
t_{rr}	$T_j = 25^\circ\text{C}$	$I_F = 0.5\text{ A}$	$I_{rr} = 0.25\text{ A}$ $I_R = 1\text{ A}$			30	ns
t_{fr}	$T_j = 25^\circ\text{C}$	$I_F = 1\text{ A}$	$t_r = 10\text{ ns}$ $V_{FR} = 1.1 \times V_F$		20		
V_{FP}	$T_j = 25^\circ\text{C}$	$I_F = 1\text{ A}$	$t_r = 10\text{ ns}$		3		V

Fig. 1: Average forward power dissipation versus average forward current.

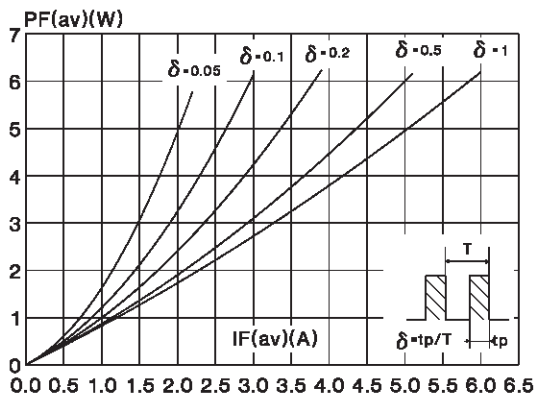

Fig. 2: Peak current versus form factor.

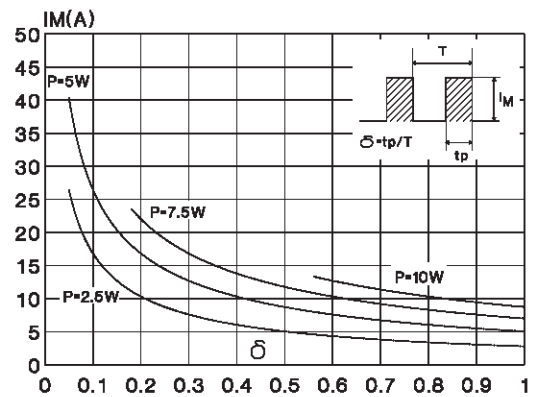

Fig. 3: Average current versus ambient temperature.

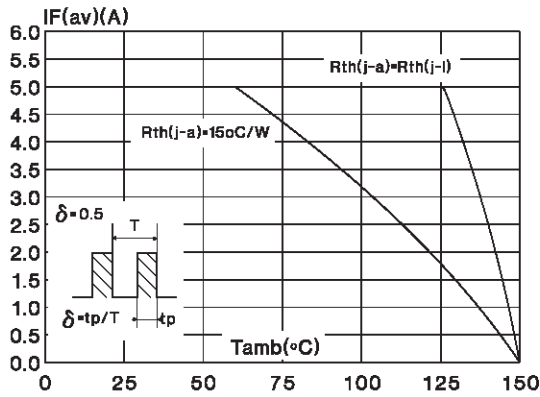

Fig. 4: Average current versus ambient temperature.

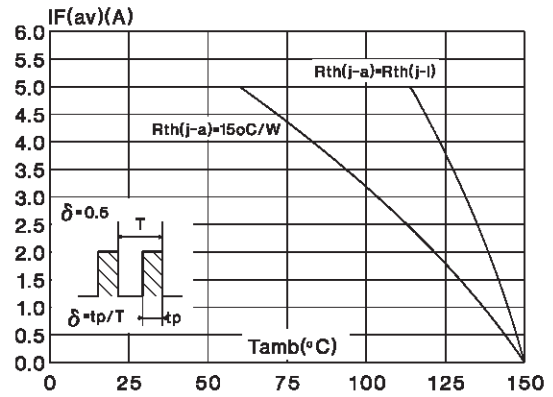

Fig. 5: Non repetitive surge peak forward current versus overload duration (maximum values) (TO-220AC).

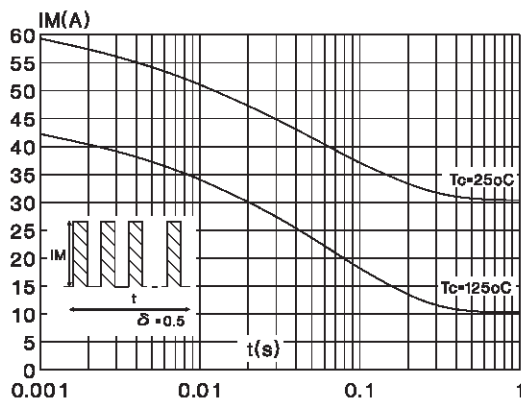

Fig. 6: Non repetitive surge peak forward current versus overload duration (maximum values) (ISOWATT220AC).

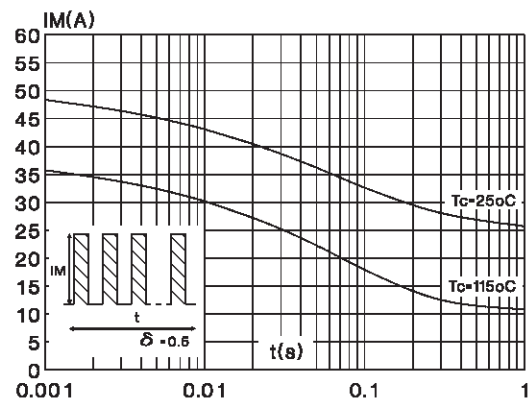

Fig. 7: Relative variation of thermal transient impedance junction to case versus pulse duration (TO-220AC).

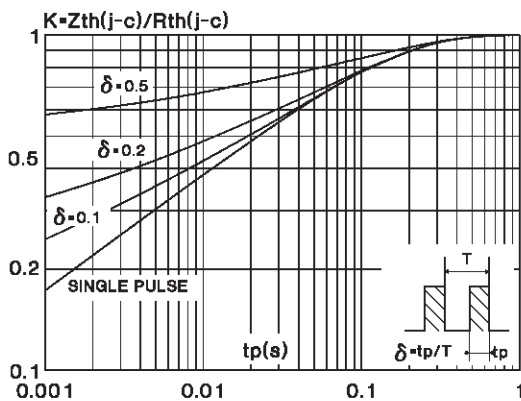
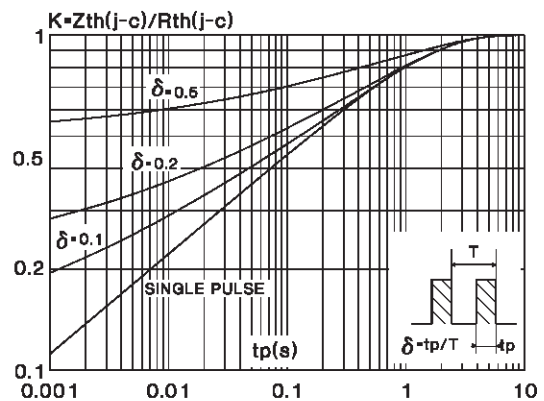

Fig. 8: Relative variation of thermal transient impedance junction to case versus pulse duration (ISOWATT220AC).



STPR520D/F

Fig. 9: Forward voltage drop versus forward current.

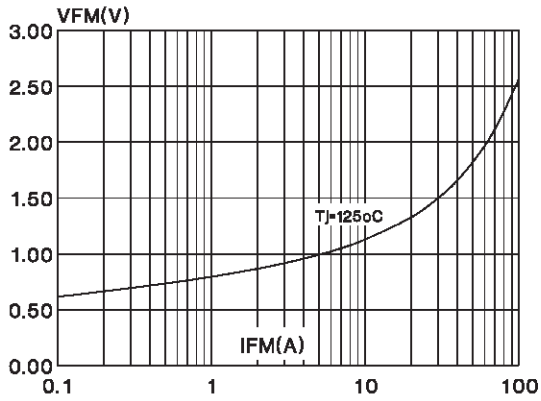

Fig. 10: Junction capacitance versus reverse voltage applied (typical values).

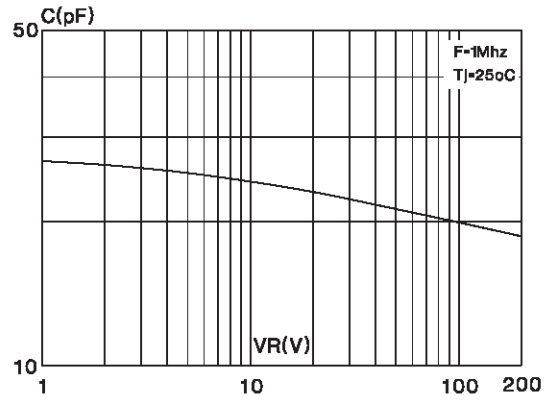

Fig. 11: Recovery charge versus di_F/dt .

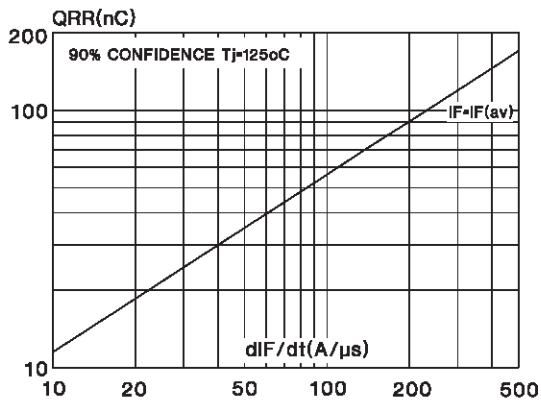

Fig. 12: Peak reverse current versus di_F/dt .

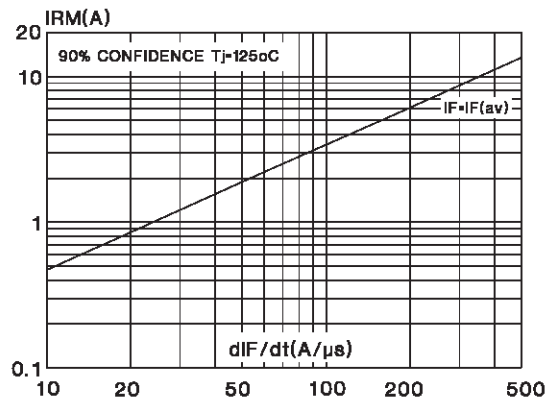
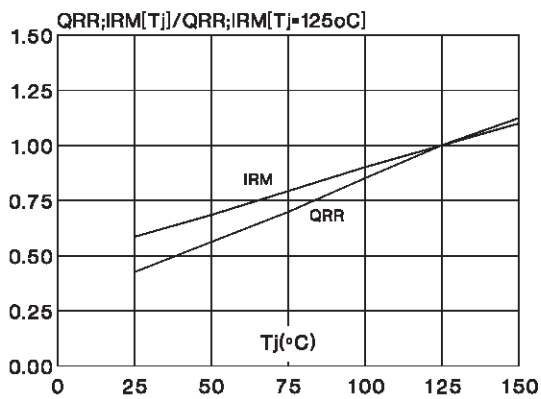
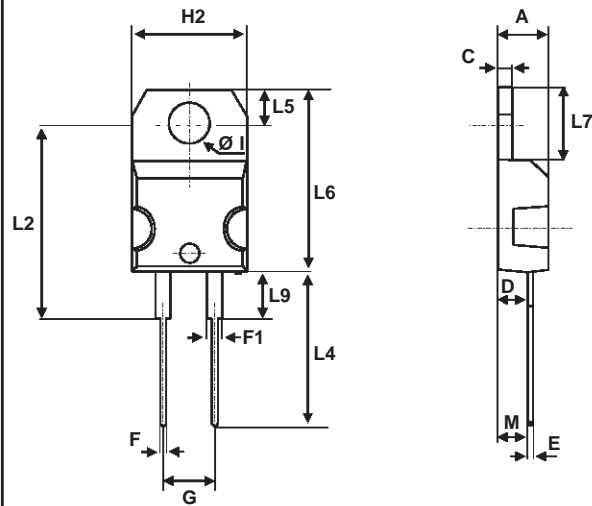

Fig. 13: Dynamic parameters versus junction temperature.



PACKAGE MECHANICAL DATA
TO-220AC



REF.	DIMENSIONS			
	Millimeters		Inches	
	Min.	Max.	Min.	Max.
A	4.40	4.60	0.173	0.181
C	1.23	1.32	0.048	0.051
D	2.40	2.72	0.094	0.107
E	0.49	0.70	0.019	0.027
F	0.61	0.88	0.024	0.034
F1	1.14	1.70	0.044	0.066
G	4.95	5.15	0.194	0.202
H2	10.00	10.40	0.393	0.409
L2	16.40 typ.		0.645 typ.	
L4	13.00	14.00	0.511	0.551
L5	2.65	2.95	0.104	0.116
L6	15.25	15.75	0.600	0.620
L7	6.20	6.60	0.244	0.259
L9	3.50	3.93	0.137	0.154
M	2.6 typ.		0.102 typ.	
Diam. I	3.75	3.85	0.147	0.151

STPR520D/F

PACKAGE MECHANICAL DATA ISOWATT220AC

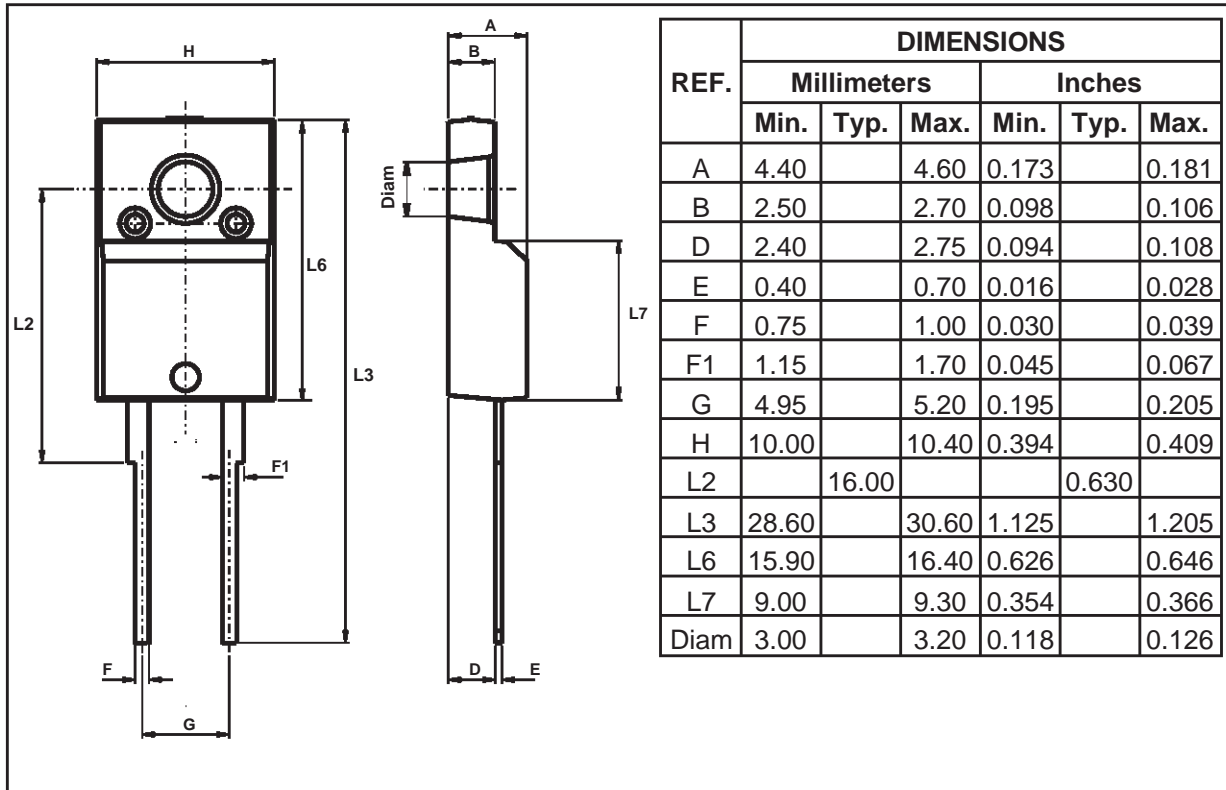

Information furnished is believed to be accurate and reliable. However, STMicroelectronics assumes no responsibility for the consequences of use of such information nor for any infringement of patents or other rights of third parties which may result from its use. No license is granted by implication or otherwise under any patent or patent rights of STMicroelectronics. Specifications mentioned in this publication are subject to change without notice. This publication supersedes and replaces all information previously supplied. STMicroelectronics products are not authorized for use as critical components in life support devices or systems without express written approval of STMicroelectronics.

The ST logo is a registered trademark of STMicroelectronics

© 1999 STMicroelectronics - Printed in Italy - All rights reserved.

STMicroelectronics GROUP OF COMPANIES

Australia - Brazil - Canada - China - France - Germany - Italy - Japan - Korea - Malaysia - Malta - Mexico - Morocco - The Netherlands - Singapore - Spain - Sweden - Switzerland - Taiwan - Thailand - United Kingdom - U.S.A.

<http://www.st.com>