

## 3 Watt Plastic Surface Mount Silicon Zener Diodes

**1SMB5913BT3  
through  
1SMB5956BT3**

This complete new line of 3 Watt Zener Diodes offers the following advantages.

### Specification Features:

- A Complete Voltage Range — 3.3 to 200 Volts
- Flat Handling Surface for Accurate Placement
- Package Design for Top Side or Bottom Circuit Board Mounting
- Available in Tape and Reel

### Mechanical Characteristics:

**CASE:** Void-free, transfer-molded plastic

**MAXIMUM CASE TEMPERATURE FOR SOLDERING PURPOSES:** 260°C for 10 seconds

**FINISH:** All external surfaces are corrosion resistant with readily solderable leads

**POLARITY:** Cathode indicated by molded polarity notch. When operated in zener mode, cathode will be positive with respect to anode.

**MOUNTING POSITION:** Any

**WEIGHT:** Modified L-Bend providing more contact area to bond pad

**WAFER FAB LOCATION:** Phoenix, Arizona

**ASSEMBLY/TEST LOCATION:** Seremban, Malaysia

**PLASTIC SURFACE MOUNT  
ZENER DIODES  
3 WATTS  
3.3–200 VOLTS**

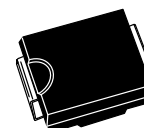

**CASE 403A  
PLASTIC**

### MAXIMUM RATINGS

Rating	Symbol	Value	Unit
DC Power Dissipation @ $T_L = 75^\circ\text{C}$ , Measured at Zero Lead Length Derate above $75^\circ\text{C}$	$P_D$	3 40	Watts $\text{mW}/^\circ\text{C}$
DC Power Dissipation @ $T_A = 25^\circ\text{C}^*$ Derate above $25^\circ\text{C}$	$P_D$	830 6.6	mW $\text{mW}/^\circ\text{C}$
Operating and Storage Junction Temperature Range	$T_J, T_{stg}$	- 65 to +150	$^\circ\text{C}$

\*FR4 Board, within 1" to device, using Motorola minimum recommended footprint, as shown in case 403A outline dimensions spec.

### ELECTRICAL CHARACTERISTICS ( $T_L = 30^\circ\text{C}$ unless otherwise noted.) ( $V_F = 1.5$ Volts Max @ $I_F = 200$ mAdc for all types.)

Device*	Nominal Zener Voltage $V_Z$ @ $I_{ZT}$ Volts (Note 1)	Test Current $I_{ZT}$ mA	Max Zener Impedance (Note 2)			Max Reverse Leakage Current		Maximum DC Zener Current $I_{ZM}$ mAdc	Device Marking
			$Z_{ZT}$ @ $I_{ZT}$ Ohms	$Z_{ZK}$ Ohms @	$I_{ZK}$ mA	$I_R$ @ $V_R$ $\mu\text{A}$ Volts			
1SMB5913BT3	3.3	113.6	10	500	1	100	1	454	913B
1SMB5914BT3	3.6	104.2	9	500	1	75	1	416	914B
<b>1SMB5915BT3</b>	<b>3.9</b>	<b>96.1</b>	<b>7.5</b>	<b>500</b>	<b>1</b>	<b>25</b>	<b>1</b>	<b>384</b>	<b>915B</b>
<b>1SMB5916BT3</b>	<b>4.3</b>	<b>87.2</b>	<b>6</b>	<b>500</b>	<b>1</b>	<b>5</b>	<b>1</b>	<b>348</b>	<b>916B</b>
<b>1SMB5917BT3</b>	<b>4.7</b>	<b>79.8</b>	<b>5</b>	<b>500</b>	<b>1</b>	<b>5</b>	<b>1.5</b>	<b>319</b>	<b>917B</b>
<b>1SMB5918BT3</b>	<b>5.1</b>	<b>73.5</b>	<b>4</b>	<b>350</b>	<b>1</b>	<b>5</b>	<b>2</b>	<b>294</b>	<b>918B</b>
<b>1SMB5919BT3</b>	<b>5.6</b>	<b>66.9</b>	<b>2</b>	<b>250</b>	<b>1</b>	<b>5</b>	<b>3</b>	<b>267</b>	<b>919B</b>
<b>1SMB5920BT3</b>	<b>6.2</b>	<b>60.5</b>	<b>2</b>	<b>200</b>	<b>1</b>	<b>5</b>	<b>4</b>	<b>241</b>	<b>920B</b>
1SMB5921BT3	6.8	55.1	2.5	200	1	5	5.2	220	921B
1SMB5922BT3	7.5	50	3	400	0.5	5	6.8	200	922B
<b>1SMB5923BT3</b>	<b>8.2</b>	<b>45.7</b>	<b>3.5</b>	<b>400</b>	<b>0.5</b>	<b>5</b>	<b>6.5</b>	<b>182</b>	<b>923B</b>
1SMB5924BT3	9.1	41.2	4	500	0.5	5	7	164	924B
<b>1SMB5925BT3</b>	<b>10</b>	<b>37.5</b>	<b>4.5</b>	<b>500</b>	<b>0.25</b>	<b>5</b>	<b>8</b>	<b>150</b>	<b>925B</b>
<b>1SMB5926BT3</b>	<b>11</b>	<b>34.1</b>	<b>5.5</b>	<b>550</b>	<b>0.25</b>	<b>1</b>	<b>8.4</b>	<b>136</b>	<b>926B</b>
<b>1SMB5927BT3</b>	<b>12</b>	<b>31.2</b>	<b>6.5</b>	<b>550</b>	<b>0.25</b>	<b>1</b>	<b>9.1</b>	<b>125</b>	<b>927B</b>
1SMB5928BT3	13	28.8	7	550	0.25	1	9.9	115	928B

(continued)

\*TOLERANCE AND VOLTAGE DESIGNATION Tolerance designation — The type numbers listed indicate a tolerance of  $\pm 5\%$ .

Devices listed in bold, italic are Motorola preferred devices.

# 1SMB5913BT3 Series

**ELECTRICAL CHARACTERISTICS — continued** ( $T_L = 30^\circ\text{C}$  unless otherwise noted.) ( $V_F = 1.5$  Volts Max @  $I_F = 200$  mAdc for all types.)

Device*	Nominal Zener Voltage $V_Z$ @ $I_{ZT}$ Volts (Note 1)	Test Current $I_{ZT}$ mA	Max Zener Impedance (Note 2)			Max Reverse Leakage Current		Maximum DC Zener Current $I_{ZM}$ mAdc	Device Marking
			$Z_{ZT}$ @ $I_{ZT}$ Ohms	$Z_{ZK}$ Ohms @	$I_{ZK}$ mA	$I_R$ @ $V_R$ $\mu\text{A}$ Volts			
<b>1SMB5929BT3</b>	<b>15</b>	<b>25</b>	<b>9</b>	<b>600</b>	<b>0.25</b>	<b>1</b>	<b>11.4</b>	<b>100</b>	<b>929B</b>
1SMB5930BT3	16	23.4	10	600	0.25	1	12.2	93	930B
<b>1SMB5931BT3</b>	<b>18</b>	<b>20.8</b>	<b>12</b>	<b>650</b>	<b>0.25</b>	<b>1</b>	<b>13.7</b>	<b>83</b>	<b>931B</b>
1SMB5932BT3	20	18.7	14	650	0.25	1	15.2	75	932B
1SMB5933BT3	22	17	17.5	650	0.25	1	16.7	68	933B
<b>1SMB5934BT3</b>	<b>24</b>	<b>15.6</b>	<b>19</b>	<b>700</b>	<b>0.25</b>	<b>1</b>	<b>18.2</b>	<b>62</b>	<b>934B</b>
<b>1SMB5935BT3</b>	<b>27</b>	<b>13.9</b>	<b>23</b>	<b>700</b>	<b>0.25</b>	<b>1</b>	<b>20.6</b>	<b>55</b>	<b>935B</b>
<b>1SMB5936BT3</b>	<b>30</b>	<b>12.5</b>	<b>26</b>	<b>750</b>	<b>0.25</b>	<b>1</b>	<b>22.8</b>	<b>50</b>	<b>936B</b>
1SMB5937BT3	33	11.4	33	800	0.25	1	25.1	45	937B
<b>1SMB5938BT3</b>	<b>36</b>	<b>10.4</b>	<b>38</b>	<b>850</b>	<b>0.25</b>	<b>1</b>	<b>27.4</b>	<b>41</b>	<b>938B</b>
1SMB5939BT3	39	9.6	45	900	0.25	1	29.7	38	939B
1SMB5940BT3	43	8.7	53	950	0.25	1	32.7	34	940B
1SMB5941BT3	47	8	67	1000	0.25	1	35.8	31	941B
1SMB5942BT3	51	7.3	70	1100	0.25	1	38.8	29	942B
1SMB5943BT3	56	6.7	86	1300	0.25	1	42.6	26	943B
1SMB5944BT3	62	6	100	1500	0.25	1	47.1	24	944B
1SMB5945BT3	68	5.5	120	1700	0.25	1	51.7	22	945B
1SMB5946BT3	75	5	140	2000	0.25	1	56	20	946B
1SMB5947BT3	82	4.6	160	2500	0.25	1	62.2	18	947B
1SMB5948BT3	91	4.1	200	3000	0.25	1	69.2	16	948B
<b>1SMB5949BT3</b>	<b>100</b>	<b>3.7</b>	<b>250</b>	<b>3100</b>	<b>0.25</b>	<b>1</b>	<b>76</b>	<b>15</b>	<b>949B</b>
1SMB5950BT3	110	3.4	300	4000	0.25	1	83.6	13	950B
1SMB5951BT3	120	3.1	380	4500	0.25	1	91.2	12	951B
1SMB5952BT3	130	2.9	450	5000	0.25	1	98.8	11	952B
1SMB5953BT3	150	2.5	600	6000	0.25	1	114	10	953B
1SMB5954BT3	160	2.3	700	6500	0.25	1	121.6	9	954B
1SMB5955BT3	180	2.1	900	7000	0.25	1	136.8	8	955B
1SMB5956BT3	200	1.9	1200	8000	0.25	1	152	7	956B

\*TOLERANCE AND VOLTAGE DESIGNATION Tolerance designation — The type numbers listed indicate a tolerance of  $\pm 5\%$ .

Devices listed in bold, italic are Motorola preferred devices.

# 1SMB5913BT3 Series

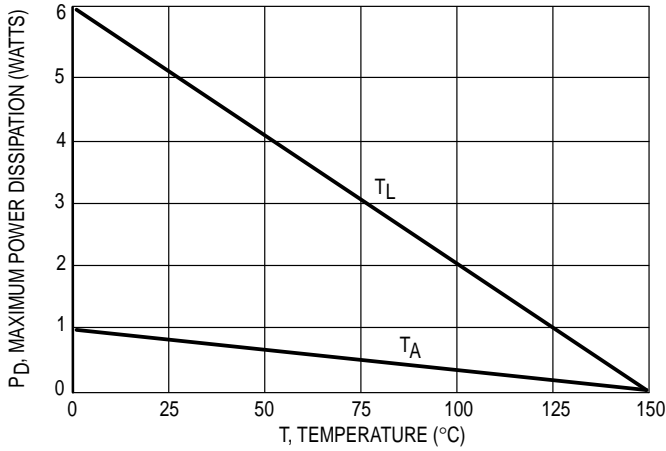

Figure 1. Steady State Power Derating

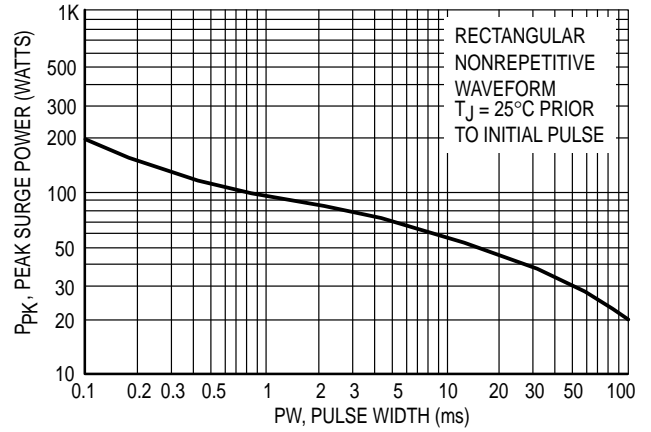

Figure 2. Maximum Surge Power

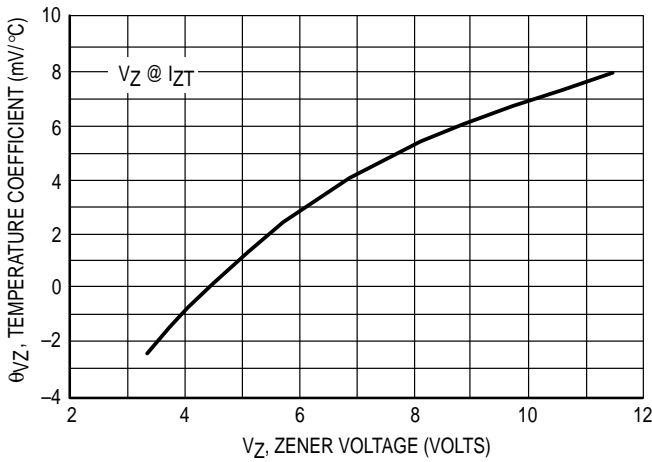

Figure 3. Zener Voltage — To 12 Volts

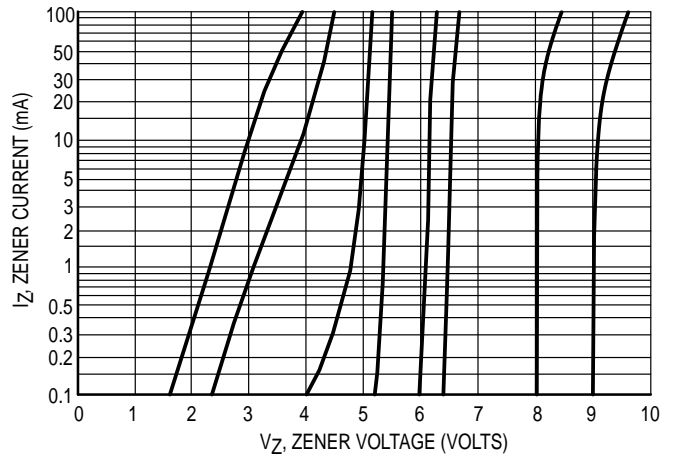

Figure 4. V<sub>Z</sub> = 3.3 thru 10 Volts

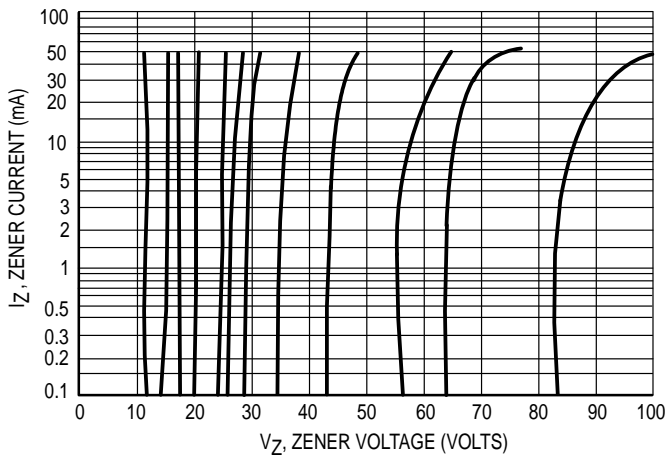

Figure 5. V<sub>Z</sub> = 12 thru 82 Volts

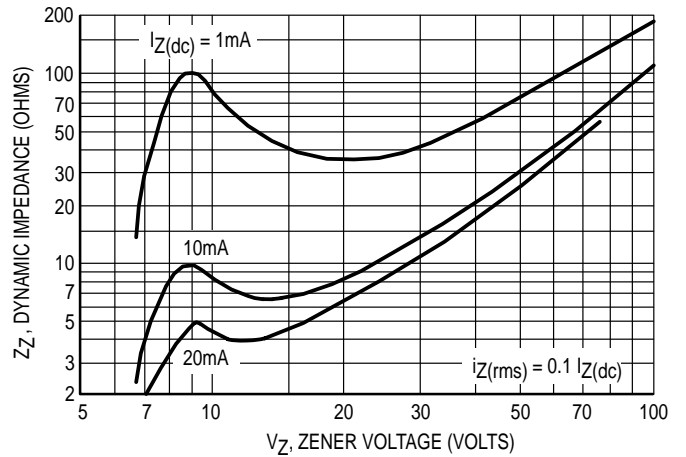
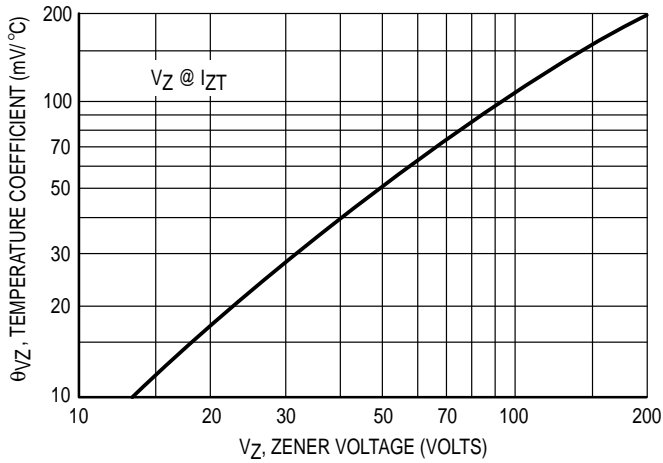

Figure 6. Effect of Zener Voltage

# 1SMB5913BT3 Series



**Figure 7. Zener Voltage — 14 To 200 Volts**

**NOTE 1. ZENER VOLTAGE ( $V_Z$ ) MEASUREMENT**

Nominal zener voltage is measured with the device junction in thermal equilibrium with ambient temperature at 25°C.

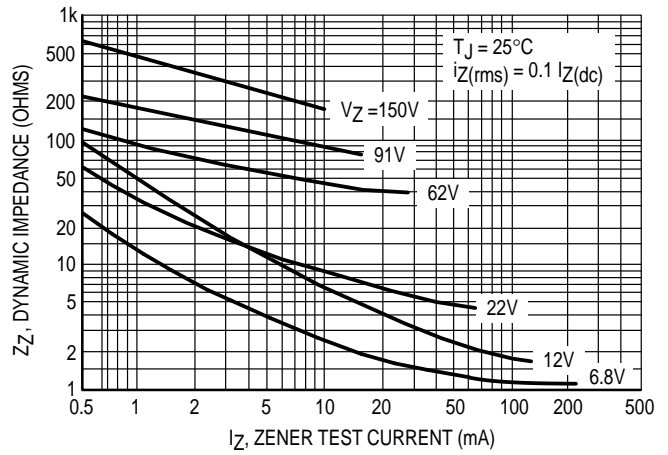

**Figure 8. Effect of Zener Current**

**NOTE 2. ZENER IMPEDANCE ( $Z_Z$ ) DERIVATION**

$Z_{ZT}$  and  $Z_{ZK}$  are measured by dividing the ac voltage drop across the device by the ac current applied. The specified limits are for  $I_Z(ac) = 0.1 I_Z(dc)$  with the ac frequency = 60 Hz.

# Zener Voltage Regulator Diodes — Surface Mounted

## 3 Watt DC Power

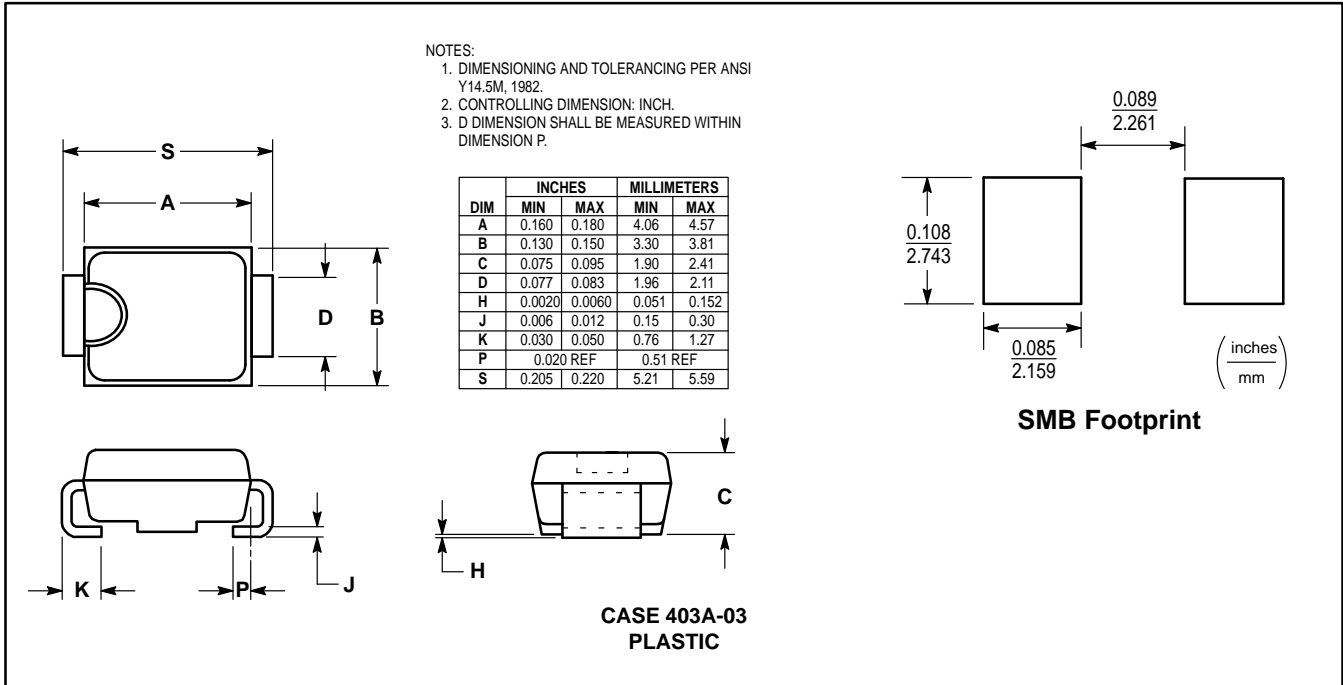

(Refer to Section 10 for Surface Mount, Thermal Data and Footprint Information.)

### MULTIPLE PACKAGE QUANTITY (MPQ) REQUIREMENTS

Package Option	Type No. Suffix	MPQ (Units)
Tape and Reel	T3 (13 inch)	2.5K

(Refer to Section 10 for more information on Packaging Specifications.)