

2N6671, 2N6672, 2N6673

File Number 1090

5-A **SwitchMax** Power Transistors

High-Voltage N-P-N Types for Off-Line Power Supplies and Other High-Voltage Switching Applications

Features:

- High-temperature parameters guaranteed
- Fast switching speed
- High voltage ratings:
 $V_{CEX} = 350\text{ V to }450\text{ V}$
- Low $V_{CE(sat)}$ at $I_C = 5\text{ A}$
- Steel hermetic TO-204AA package

Applications:

- Off-line power supplies
- High-voltage inverters
- Switching regulators

TERMINAL DESIGNATIONS

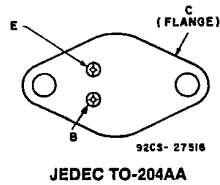

The RCA-2N6671, 2N6672, and 2N6673* SwitchMax series of silicon n-p-n power transistors feature high-voltage capability, fast switching speeds, and low saturation voltages, together with high safe-operating-area (SOA) ratings. They are specially designed for use in off-line power supplies and are also well suited for use in a wide range of inverter or converter circuits and pulse-width-modulated regulators. These high-voltage, high-speed tran-

sistors are 100-per-cent tested for parameters that are essential to the design of industrial high-power switching circuits. Switching times, including inductive turn-off time, and saturation voltages are guaranteed at 125°C to provide information necessary for worst-case design.

The RCA-2N6671, 2N6672, and 2N6673 series transistors are supplied in steel JEDEC TO-204AA hermetic packages.

*Formerly RCA8767, RCA8767A, and RCA8767B, respectively.

MAXIMUM RATINGS, Absolute-Maximum Values:

	2N6671	2N6672	2N6673	
* V_{CEV} $V_{BE} = -1.5\text{ V}$	450	550	650	V
* V_{CEX} (Clamped) $V_{BE} = -1.5\text{ V}$	350	400	450	V
* V_{CEO}	300	350	400	V
* V_{EBO}	8	8	8	V
* $I_{C(sat)}$	5	5	5	A
* I_C	8	8	8	A
* I_{CM}	10	10	10	A
* I_B	4	4	4	A
* P_T T_C up to 25°C	150	150	150	W
T_C above 25°C, derate linearly	0.86	0.86	0.86	W/°C
* T_{stg} , T_J	-65 to 200	-65 to 200	-65 to 200	°C
* T_L At distance $\geq 1/16$ in. (1.58 mm) from seating plane for 10 s max.	235	235	235	°C

* In accordance with JEDEC registration data.

2N6671, 2N6672, 2N6673

ELECTRICAL CHARACTERISTICS

CHARACTERISTIC	TEST CONDITIONS				LIMITS						UNITS
	VOLTAGE V _{dc}		CURRENT A _{dc}		2N6671		2N6672		2N6673		
	V _{CE}	V _{BE}	I _C	I _B	Min.	Max.	Min.	Max.	Min.	Max.	

T_C = 25°C

* I _{CEV}	450 550 650	-1.5 -1.5 -1.5			-	0.1	-	-	-	-	-	-	-	-	-	-	-	-	-	mA		
* I _{EBO}		-8	0		-	2	-	2	-	2	-	2	-	2	-	2	-	2	-	2	V	
* V _{CEO(sus)} ^b			0.2 ^a	0	300	-	350	-	400	-	400	-	400	-	400	-	400	-	400	-	V	
* h _{FE}	3		5 ^a		10	40	10	40	10	40	10	40	10	40	10	40	10	40	10	40		
* V _{BE(sat)}			5 ^a	1	-	1.6	-	1.6	-	1.6	-	1.6	-	1.6	-	1.6	-	1.6	-	1.6	V	
* V _{CE(sat)}			5 ^a	1	-	1	-	1	-	1	-	1	-	1	-	1	-	1	-	1	V	
* V _{CEX} ^b (Clamped E _S /b) L=170 μH, R _{BB} =5 Ω		-5 -5	5 8	1 ^e 3 ^e	350 200	-	400 250	-	450 300	-	450 300	-	450 300	-	450 300	-	450 300	-	450 300	-	450 300	V
* I _S /b	25		6		1	-	1	-	1	-	1	-	1	-	1	-	1	-	1	-	s	
* h _{fe} f=5 MHz	10		0.2		3	12	3	12	3	12	3	12	3	12	3	12	3	12	3	12		
* f _T	10		0.2		15	60	15	60	15	60	15	60	15	60	15	60	15	60	15	60	MHz	
* C _{obo} f=0.1 MHz	10 ^c				50	300	50	300	50	300	50	300	50	300	50	300	50	300	50	300	pF	
* t _d ^d			5	1	-	0.1	-	0.1	-	0.1	-	0.1	-	0.1	-	0.1	-	0.1	-	0.1	μs	
* t _r ^d			5	1	-	0.5	-	0.5	-	0.5	-	0.5	-	0.5	-	0.5	-	0.5	-	0.5	μs	
* t _s ^d			5	1 ^e	-	2.5	-	2.5	-	2.5	-	2.5	-	2.5	-	2.5	-	2.5	-	2.5	μs	
* t _f ^d			5	1 ^e	-	0.4	-	0.4	-	0.4	-	0.4	-	0.4	-	0.4	-	0.4	-	0.4	μs	
* t _c V _{CC} =125 V, L=170 μH, R _C =25 Ω Collector clamped to V _{CEX}			5	1 ^e	-	0.4	-	0.4	-	0.4	-	0.4	-	0.4	-	0.4	-	0.4	-	0.4	μs	

T_C = 125°C

* I _{CEV}	450 550 650	-1.5 -1.5 -1.5			-	1	-	-	-	-	-	-	-	-	-	-	-	-	-	-	-	mA
* V _{CE(sat)}			5 ^a	1	-	2	-	2	-	2	-	2	-	2	-	2	-	2	-	2	-	V
* t _r ^d			5	1	-	0.8	-	0.8	-	0.8	-	0.8	-	0.8	-	0.8	-	0.8	-	0.8	-	μs
* t _s ^d			5	1 ^e	-	4	-	4	-	4	-	4	-	4	-	4	-	4	-	4	-	μs
* t _f ^d			5	1 ^e	-	0.8	-	0.8	-	0.8	-	0.8	-	0.8	-	0.8	-	0.8	-	0.8	-	μs
* t _c V _{CC} =125 V, L=170 μH, R _C =25 Ω Collector clamped to V _{CEX}			5	1 ^e	-	0.8	-	0.8	-	0.8	-	0.8	-	0.8	-	0.8	-	0.8	-	0.8	-	μs

* R _{θJC}					-	1.17	-	1.17	-	1.17	-	1.17	-	1.17	-	1.17	-	1.17	-	1.17	-	°C/W
--------------------	--	--	--	--	---	------	---	------	---	------	---	------	---	------	---	------	---	------	---	------	---	------

* In accordance with JEDEC registration data.
^a Pulsed: pulse duration = 300 μs, duty factor ≤ 2%.
^b CAUTION: The sustaining voltage V_{CEO(sus)} and V_{CEX} MUST NOT be measured on a curve tracer.
^c V_{CB} value.
^d V_{CC} = 125 V, t_p = 20 μs.
^e I_{B1} = -I_{B2}.

2N6671, 2N6672, 2N6673

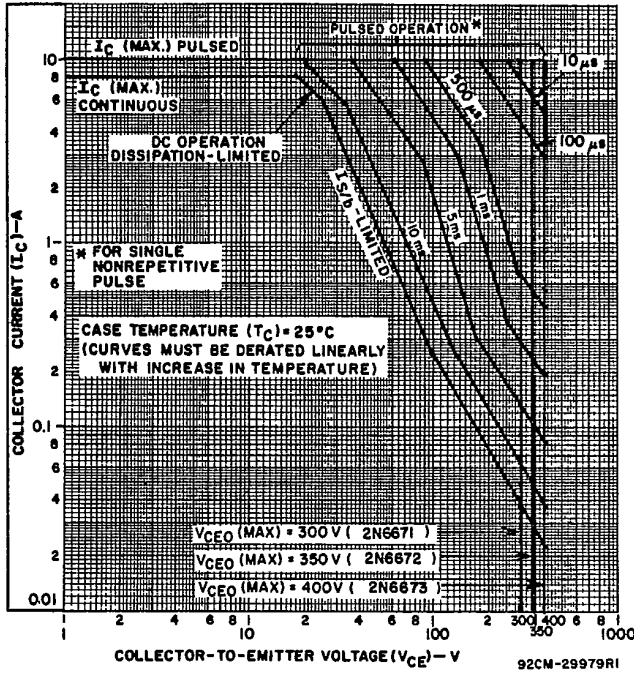

Fig. 1 — Maximum operating areas for all types ($T_c = 25^\circ C$).

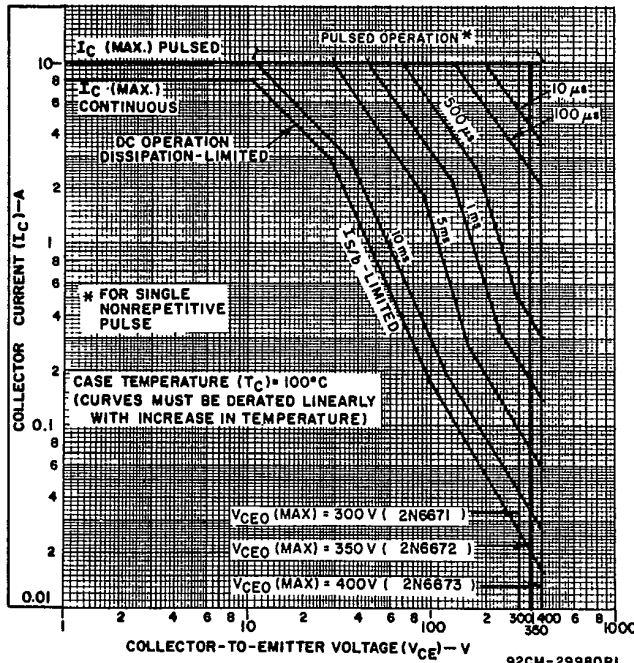

Fig. 2 — Maximum operating areas for all types ($T_c = 100^\circ C$).

2N6671, 2N6672, 2N6673

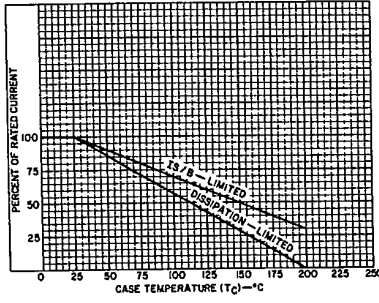

Fig. 3 - Dissipation and I_{SIB} derating curves for all types.

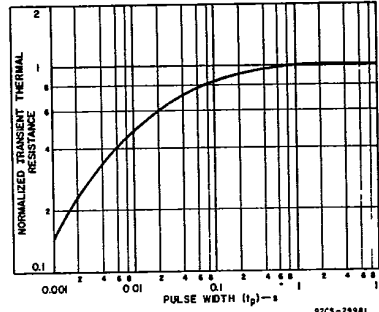

Fig. 4 - Typical thermal-response characteristic for all types.

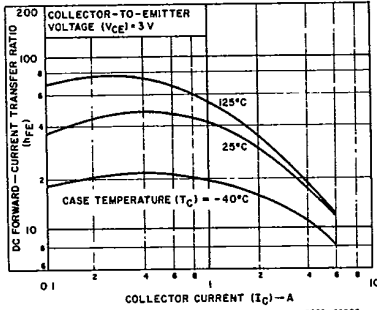

Fig. 5 - Typical dc beta characteristics for all types.

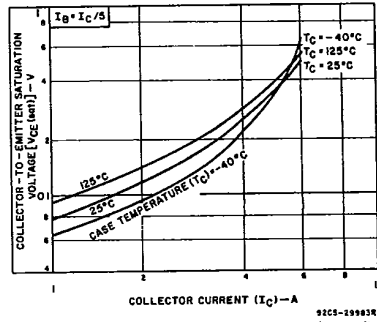

Fig. 6 - Typical collector-to-emitter saturation voltage as a function of collector current for all types.

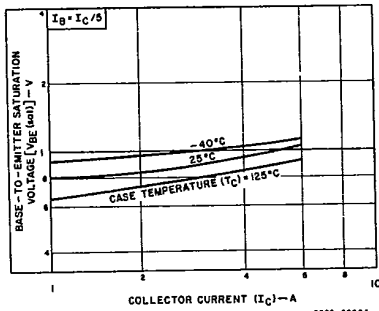

Fig. 7 - Typical base-to-emitter saturation voltage as a function of collector current for all types.

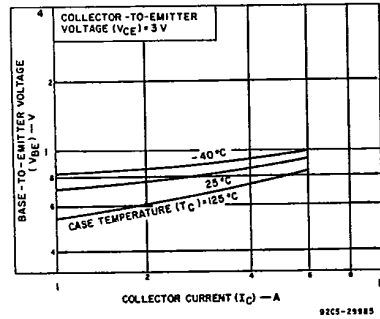

Fig. 8 - Typical base-to-emitter voltage as a function of collector current for all types.

2N6671, 2N6672, 2N6673

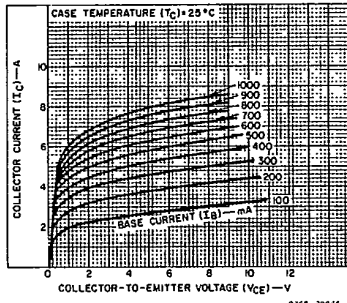

Fig. 9 — Typical output characteristics for all types.

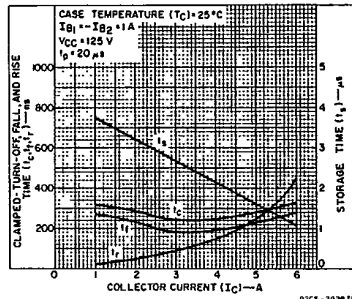

Fig. 10 — Typical saturated switching time characteristics for all types.

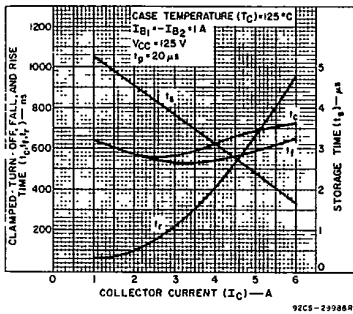

Fig. 11 — Typical saturated switching time characteristics for all types.

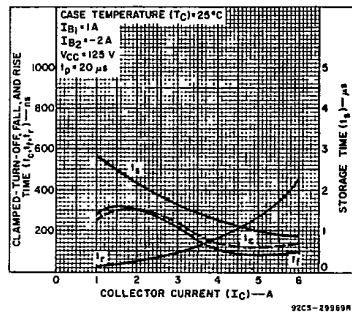

Fig. 12 — Typical saturated switching time characteristics for all types.

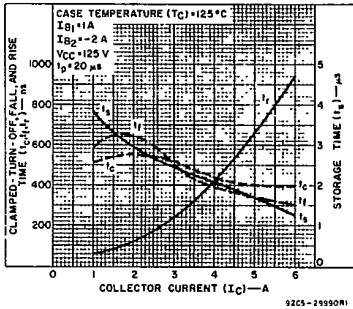

Fig. 13 — Typical saturated switching time characteristics for all types.

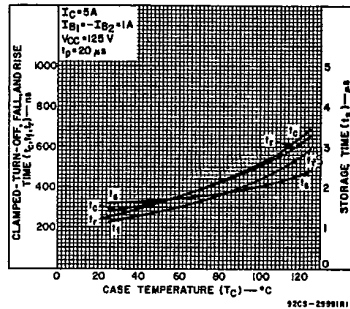

Fig. 14 — Typical saturated switching time characteristics as a function of

2N6671, 2N6672, 2N6673

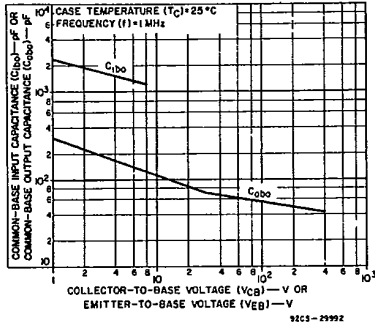

Fig. 15 — Typical common-base input or output capacitance characteristics as a function of collector-to-base voltage or emitter-to-base voltage for all types.

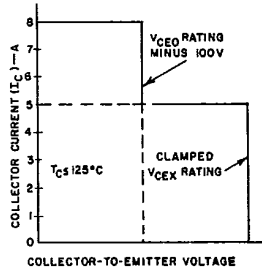

Fig. 16 — Maximum operating conditions for switching between saturation and cutoff.

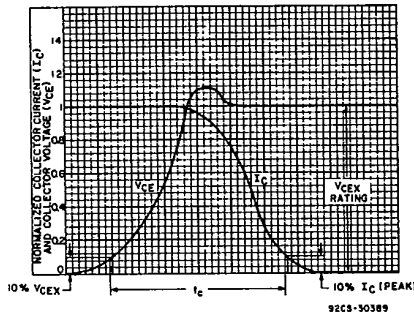

Fig. 17 — Oscilloscope display for measurement of clamped induction switching time (t_c).

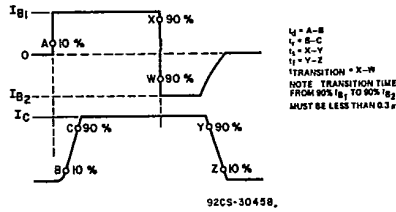

Fig. 18 — Phase relationship between input and output currents showing reference points for specification of switching times.

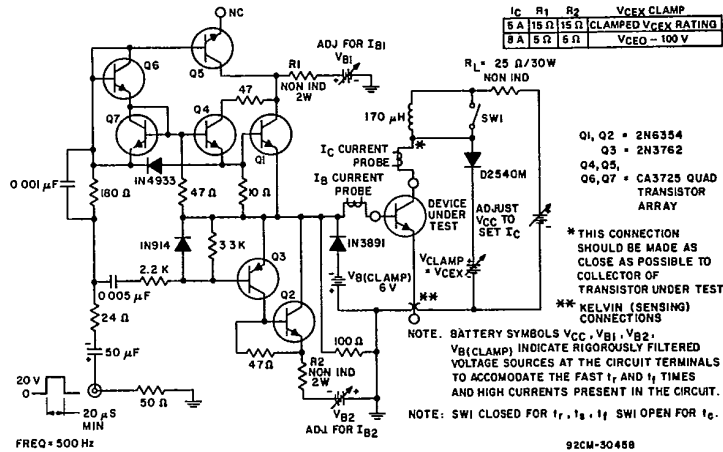

Fig. 19 — Circuit for measuring switching times.