

# RECTIFIER ASSEMBLIES

## Three Phase Bridges, 15-25 Amp, Standard and Fast Recovery Magnum®

678, 682, 695  
696 SERIES

3

### FEATURES

- Current Rating: to 25A
- PIVs: from 100 to 600V
- Only Fused-in-Glass Diodes Used
- Recovery Times: to 500ns
- Controlled Avalanche Characteristics
- Surge Ratings: to 150A
- Aluminum Heat Sink Case, Electrically Insulated

### DESCRIPTION

This series of three phase MAGNUM® bridges offer the ultimate in high current power supply applications. The fast recovery series allows operation at full power at high frequencies (up to 40KHz squarewave), often used in choppers, inverters and converters in aircraft, missiles, etc., equipment.

### ABSOLUTE MAXIMUM RATINGS

Peak Inverse Voltage .....	100 to 600V
Maximum Average D.C. Output Current .....	See Electrical Specifications
Non-Repetitive Sinusoidal Surge (8.3ms) .....	See Electrical Specifications
Operating and Storage Temperature Range, T <sub>C</sub> .....	-65°C to +150°C
Thermal Resistance Junction to Ambient, All Series .....	20°C/W
Junction to Case, 678, 682 Series .....	1.5°C/W
Junction to Case, 695, 696 Series .....	3.0°C/W

### MECHANICAL SPECIFICATIONS

**678, 682, 695, 696 SERIES**

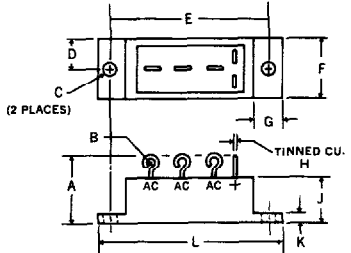

	ins.	mm.
A	.820 MAX.	20.83 MAX.
B	.09 DIA. TYP.	2.29 DIA. TYP.
C	.164-.174 DIA.	4.17-4.42 DIA.
D	.365-.385	9.27-9.78
E	1.870-1.880	47.50-47.75
F	.740-.760	18.80-19.30
G	.370-.390	9.40-9.91
H	.040 TYP.	1.02 TYP.
J	.486-.506	12.34-12.85
K	.115-.135	2.92-3.43
L	2.240-2.260	56.90-57.40

Typical Weight — 30 grams

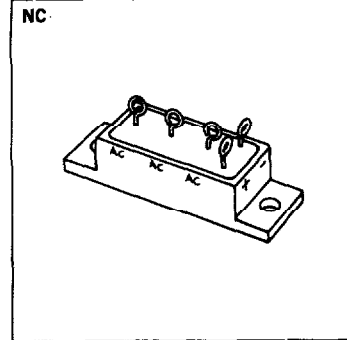

### MARKING

Alternating Current Input	A.C.
Cathode — Positive Output	+
Anode — Negative	-

Part number is printed on the body.

**Microsemi Corp.**  
**Watertown**  
The diode experts

Electrical Specifications (at 25°C unless noted)						Maximum Ratings			
Type	PIV Per Leg	Maximum Forward Voltage Drop Per Leg	Maximum Leakage Current Per Leg @ PIV		Maximum Reverse Recovery Time*	Maximum Average D.C. Output Current		Non-Repetitive Sinusoidal Surge (8.3ms) $T_A = 100^\circ\text{C}$	
			$T_A = 25^\circ\text{C}$	$T_A = 100^\circ\text{C}$		$T_C = 55^\circ\text{C}$	$T_C = 100^\circ\text{C}$		
	Volts		$\mu\text{A}$	$\mu\text{A}$	ns	Amps	Amps	Amps	
Standard Recovery	678-1	100	1.2V @ 10A	10	200	—	25	18.5	150
	678-2	200							
	678-3	300							
	678-4	400							
	678-5	500							
	678-6	600							
Standard Recovery	695-1	100	1.2V @ 2A	5	150	—	15	9	80
	695-2	200							
	695-3	300							
	695-4	400							
	695-5	500							
	695-6	600							
Fast Recovery	682-1	100	1.2V @ 6A	10	200	500	20	14	150
	682-2	200							
	682-3	300							
	682-4	400							
	682-5	500							
	682-6	600							
Fast Recovery	696-1	100	1.2V @ 2A	5	150	500	15	9	60
	696-2	200							
	696-3	300							
	696-4	400							
	696-5	500							
	696-6	600							

\*Measured in a reverse recovery circuit switching from 1.0A forward to 1.0A reverse current recovering to 0.5A.

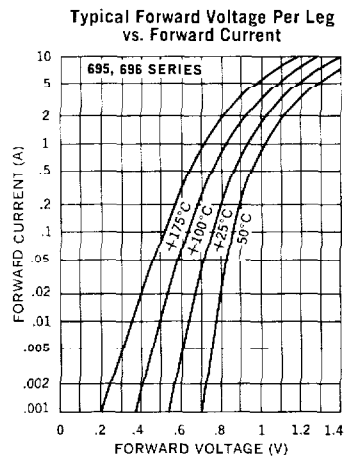
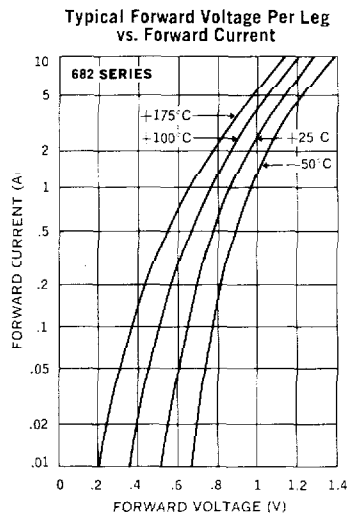
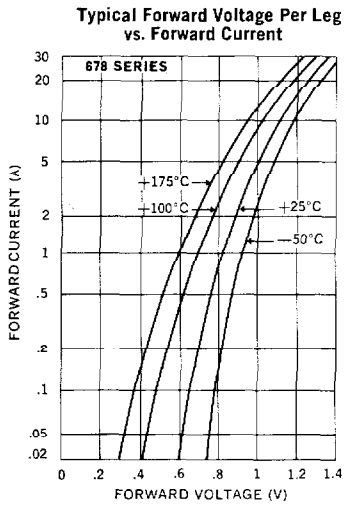

Typical Leakage Current vs. PIV

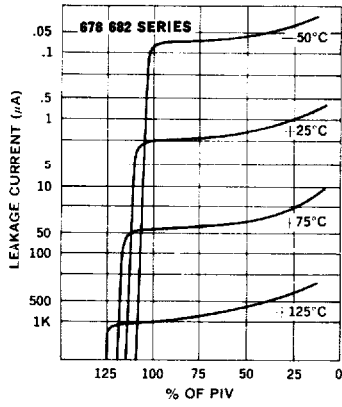

Typical Leakage Current vs. PIV

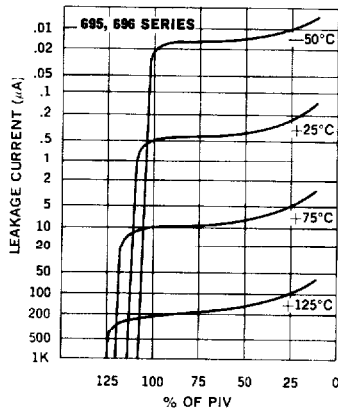

Reverse Recovery Circuit

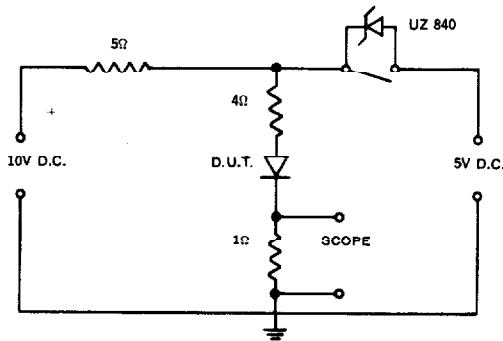

Current Derating Curve

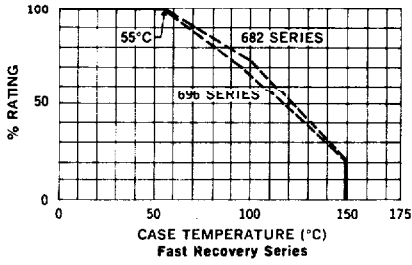

Current Derating Curve

