



NEC's HIGH CMR, 10 Mbps OPEN COLLECTOR OUTPUT TYPE 5-PIN SOP PHOTOCOUPLER

PS9114

FEATURES

- **HIGH COMMON MODE TRANSIENT IMMUNITY**
CMH, CML = ± 20 kV/ μ s TYP
- **SMALL PACKAGE**
5-pin SOP
- **HIGH SPEED**
10 Mbps
- **PULSE WIDTH DISTORTION**
 $|t_{PHL} - t_{PLH}| = 3$ ns TYP
- **HIGH ISOLATION VOLTAGE**
BV = 2500 Vr.m.s.
- **OPEN COLLECTOR OUTPUT**
- **AVAILABLE IN TAPE AND REEL**
PS9114-F3, F4: 2500 pcs/reel

DESCRIPTION

NEC's PS9114 is an optically coupled high-speed, isolator containing a GaAlAs LED on the input side and a photodiode and a signal processing circuit on the output side on one chip.

APPLICATIONS

- **FACTORY AUTOMATION NETWORK**
- **MEASUREMENT EQUIPMENT**
- **MOTOR DRIVE / INVERTER**

ELECTRICAL CHARACTERISTICS (TA = 0 to +85°C, Unless otherwise specified)

PART NUMBER				PS9114		
	SYMBOL	PARAMETERS	UNITS	MIN	TYP ¹	MAX
Diode	V _F	Forward Voltage, I _F = 10 mA, T _A = 25°C	V	1.4	1.65	1.9
	I _R	Reverse Current, V _R = 3 V, T _A = 25°C	μ A			10
	C _t	Capacitance, V = 0, f = 1 MHz, T _A = 25°C	pF		30	
Detector	I _{OH}	High Level Output Current V _{CC} = V _O = 5.5 V, V _F = 0.8 V	μ A		0.02	250
	V _{OL}	Low Level Output Voltage ² V _{CC} = 5.5 V, I _F = 5 mA, I _{OL} = 13 mA	V		0.15	0.6
	I _{CCH}	High Level Supply Current, V _{CC} = 5.5 V, I _F = 0 mA	mA		3	8
	I _{CCL}	Low Level Supply Current, V _{CC} = 5.5 V, I _F = 10 mA	mA		7.0	11
Coupled	I _{FHL}	Threshold Input Current, High \rightarrow Low, V _{CC} = 5 V, V _O = 0.8V, R _L = 350 Ω	mA		2	5
	R _{I-O}	Isolation Resistance, V _{I-O} = 1 k V _{DC} , R _H = 40 to 60%, T _A = 25°C	Ω	10 ¹¹		
	C _{I-O}	Isolation Capacitance, V = 0, f = 1 MHz, T _A = 25°C	pF		0.6	
	t _{PHL}	Propagation Delay Time ³ , High \rightarrow Low V _{CC} = 5 V, R _L = 350 Ω , I _F = 7.5 mA	ns		54	75 100
	t _{PLH}	Propagation Delay Time ³ , Low \rightarrow High V _{CC} = 5 V, R _L = 350 Ω , I _F = 7.5 mA	ns		51	75 100
	t _r	Rise Time, V _{CC} = 5 V, R _L = 350 Ω , I _F = 7.5 mA	mA		20	
	t _f	Fall Time, V _{CC} = 5 V, R _L = 350 Ω , I _F = 7.5 mA	mA		10	

Continued on next page

ELECTRICAL CHARACTERISTICS ($T_A = 0$ to $+85^\circ\text{C}$, Unless otherwise specified), Continued

		PART NUMBER			PS9114		
SYMBOL		PARAMETERS	UNITS	MIN	TYP	MAX	
Coupled	$ t_{PHL} - t_{PLH} $	Pulse Width Distortion, (PWD) ³ , $V_{CC} = 5\text{ V}$, $R_L = 350\ \Omega$, $I_F = 7.5\text{ mA}$	ns		3	50	
	t_{PSK}	Propagation Delay Skew, $V_{CC} = 5\text{ V}$, $R_L = 350\ \Omega$, $I_F = 7.5\text{ mA}$	ns			60	
	CMH	Common Mode Transient Immunity at High Level Output ⁴ , $V_{CC} = 5\text{ V}$, $T_A = 25^\circ\text{C}$, $I_F = 0\text{ mA}$, $V_O(\text{MIN}) = 2\text{ V}$, $V_{CM} = 1\text{ kV}$	kV/ μs	10	20		
	CML	Common Mode Transient Immunity at Low Level Output ⁴ , $V_{CC} = 5\text{ V}$, $T_A = 25^\circ\text{C}$, $I_F = 7.5\text{ mA}$, $V_O(\text{MAX}) = 0.8\text{ V}$, $V_{CM} = 1\text{ kV}$	kV/ μs	10	20		

Notes:

- Typical values at $T_A = 25^\circ\text{C}$.
- Because V_{OL} of 2 V or more may be output when LED current input and when output supply of $V_{CC} = 2.6\text{ V}$ or less, it is important to confirm the characteristics (operation with the power supply on and off) during design, before using this device..
- Test Circuit for Propagation delay time

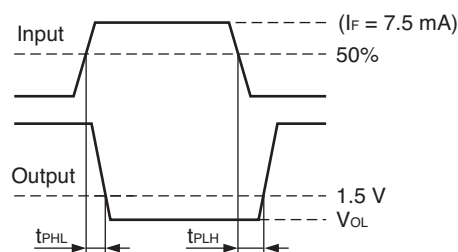
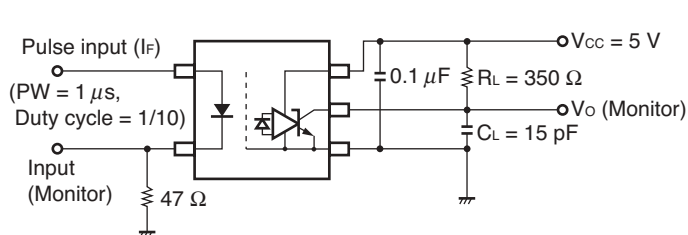

4. Test Circuit for common mode transient immunity

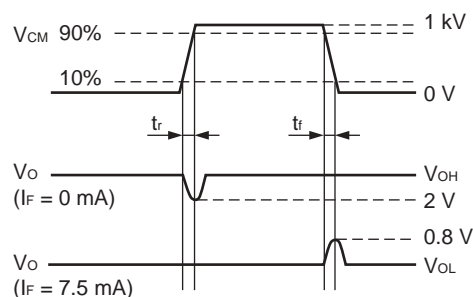
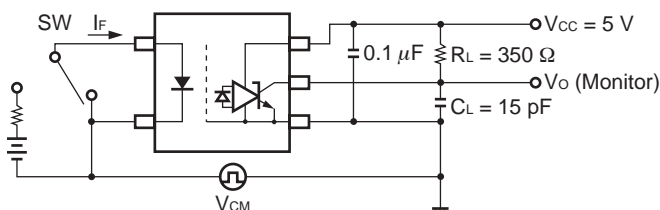

Remark C_L includes probe and stray wiring capacitance.

USAGE CAUTIONS

- This device is ESD sensitive.
- Bypass capacitor of more than $0.1\ \mu\text{F}$ must be used between V_{CC} and GND within 10 mm of the device.

ABSOLUTE MAXIMUM RATINGS¹ ($T_A = 25^\circ\text{C}$)

SYMBOLS	PARAMETERS	UNITS	RATINGS
Diode			
I_F	Forward Current	mA	30
V_R	Reverse Voltage	V	5
Detector			
V_{CC}	Supply Voltage	V	7
V_O	Output Voltage	V	7
I_O	Output Current	mA	25
P_C	Power Dissipation ²	mW	40
Coupled			
BV	Isolation Voltage ³	$V_{r.m.s.}$	2500
T_A	Operating Temperature	$^\circ\text{C}$	-40 to +85
T_{STG}	Storage Temperature	$^\circ\text{C}$	-55 to +125

Notes:

- Operation in excess of any one of these parameters may result in permanent damage.
- Applies to output pin V_O . Reduced to $1.5\text{ mW}/^\circ\text{C}$ at $T_A = 65^\circ\text{C}$ or more.
- AC voltage for 1 minute at $T_A = 25^\circ\text{C}$, $RH = 60\%$ between input and output.

RECOMMENDED OPERATING CONDITIONS

PART NUMBER			PS9114		
SYMBOLS	PARAMETERS	UNITS	MIN	TYP	MAX
V_{FL}	Low Level Input Voltage	mA	0		0.8
I_{FH}	High Level Input Current	mA	6.3	10	12.5
V_{CC}	Supply Voltage	V	4.5	5.0	5.5
N	TTL($R_L = 1\text{ k}\Omega$ loads)				5
R_L	Operating Temperature	Ω	300		4 k

ORDERING INFORMATION

PART NUMBER	PACKAGE	PACKAGE STYLE	APPLICATION PART NUMBER*
PS9114	5-pin SOP	Magazine case 100 PCS	PS9114
PS9114-F3		Embossed Tape 2500 pcs/reel	
PS9114-F4			

* For the application of the Safety Standard, following part number should be used.

TYPICAL PERFORMANCE CURVES (TA = 25°C)

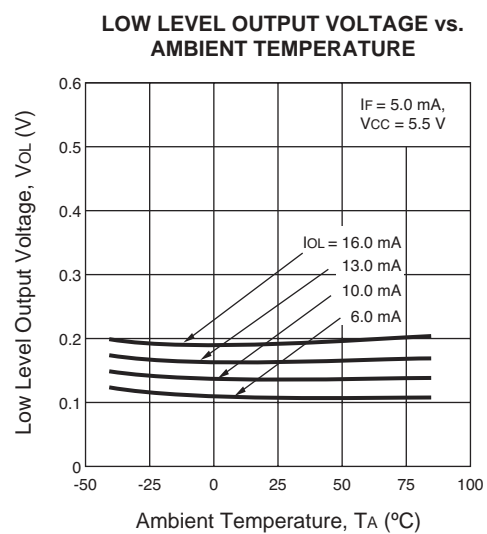
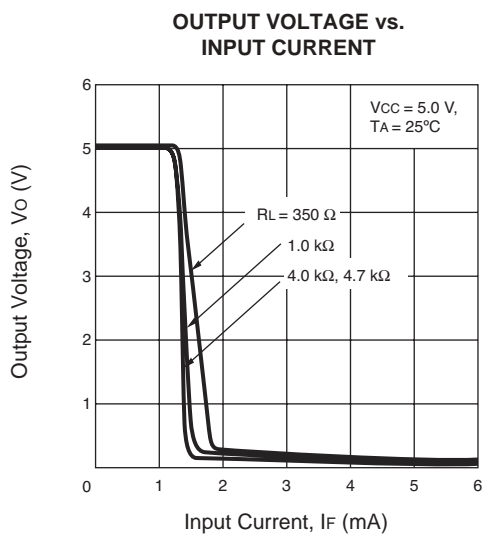
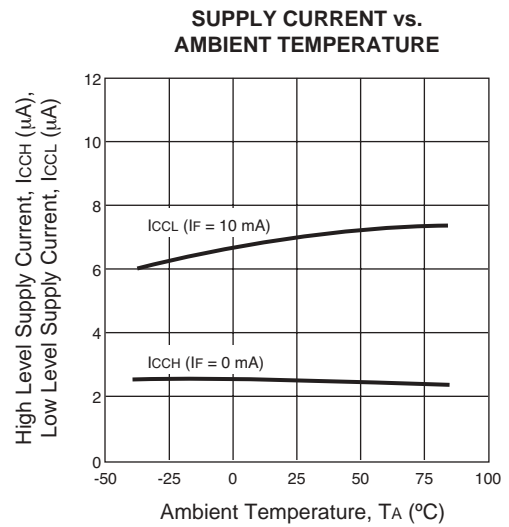
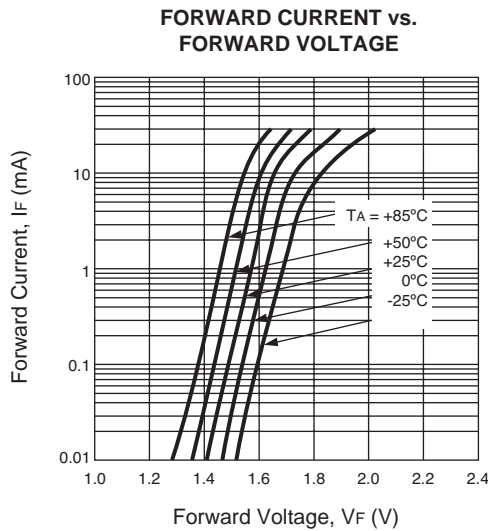
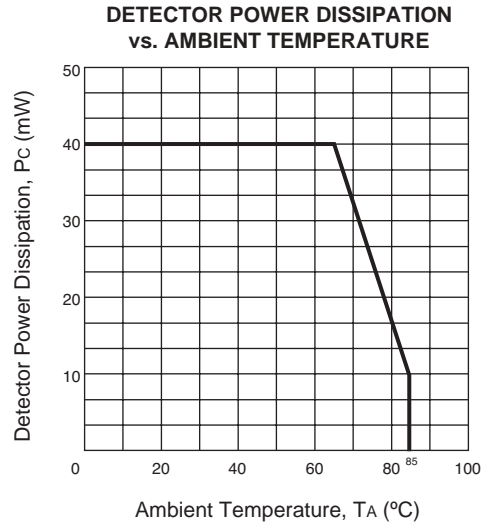
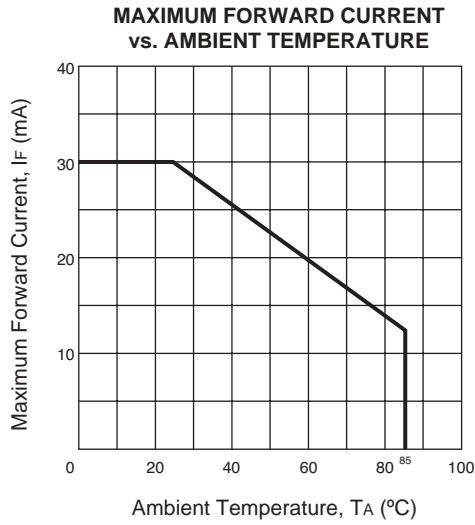

TYPICAL PERFORMANCE CURVES (TA = 25°C)

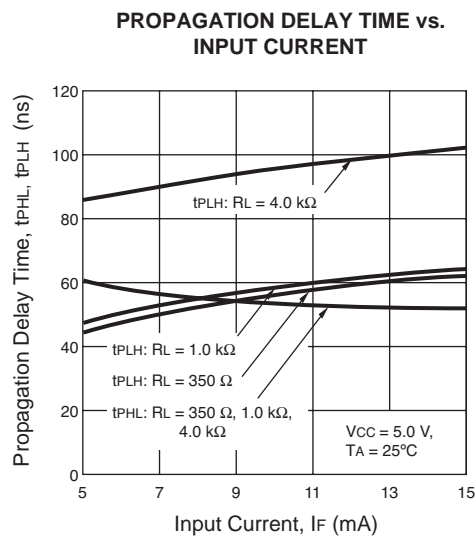
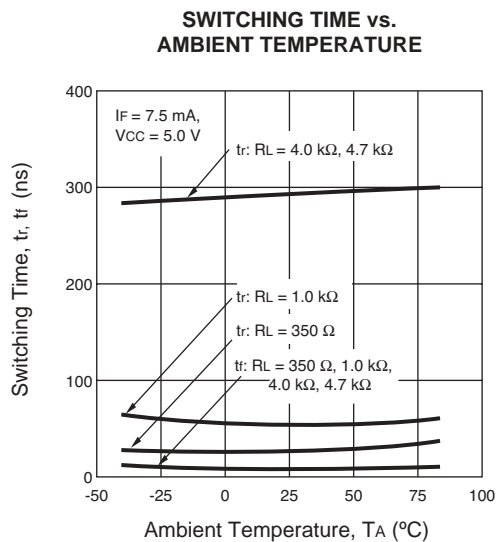
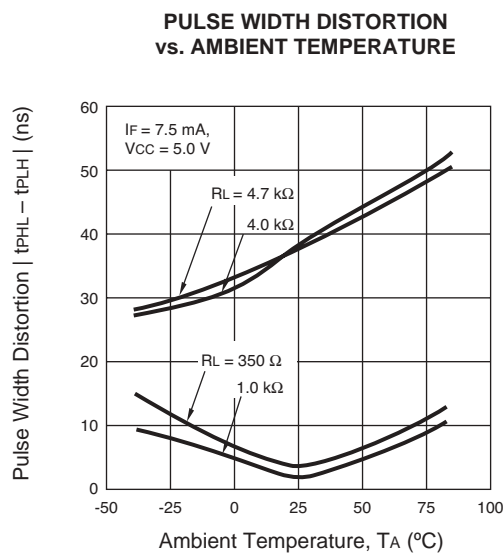
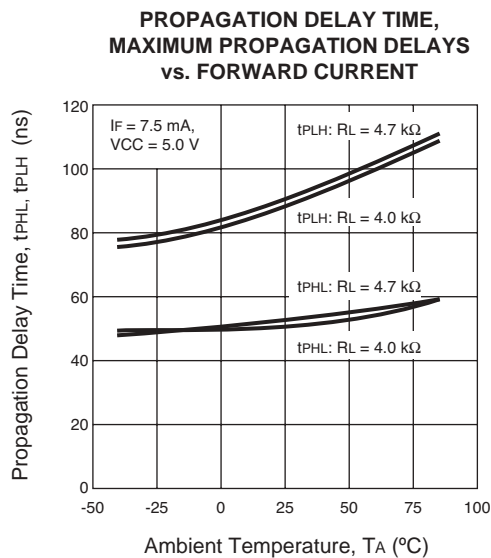
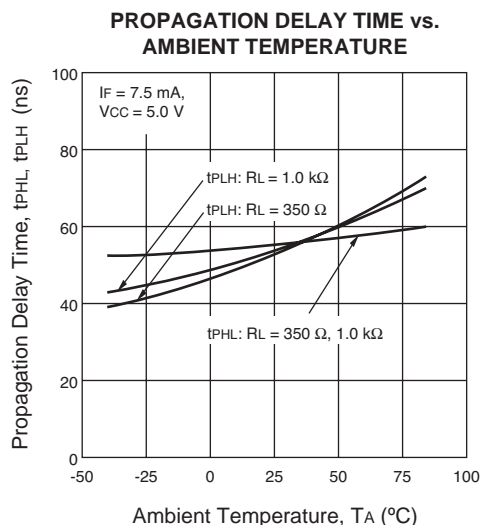
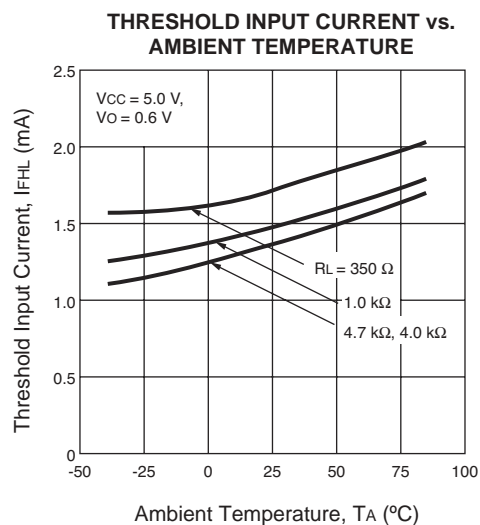

OUTLINE DIMENSIONS (Units in mm)

MARKING

PS9114

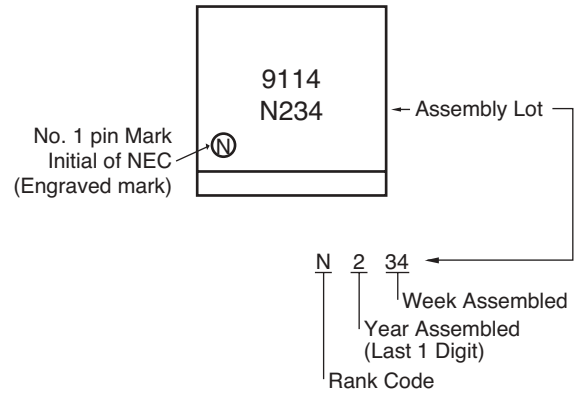
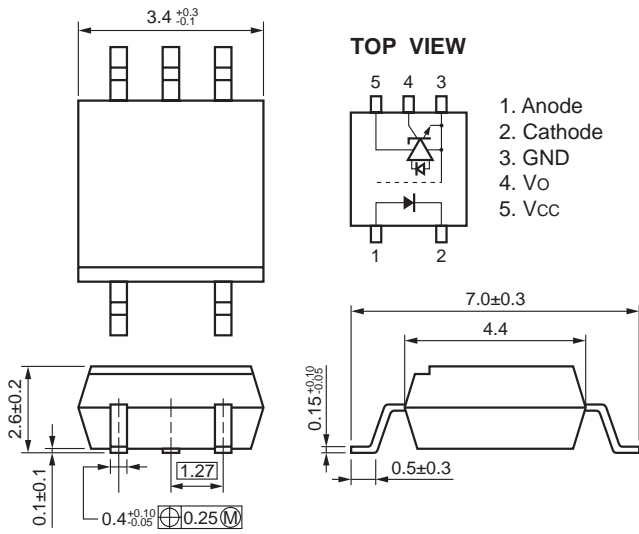

Life Support Applications

These NEC products are not intended for use in life support devices, appliances, or systems where the malfunction of these products can reasonably be expected to result in personal injury. The customers of CEL using or selling these products for use in such applications do so at their own risk and agree to fully indemnify CEL for all damages resulting from such improper use or sale.

CEL California Eastern Laboratories, Your source for NEC RF, Microwave, Optoelectronic, and Fiber Optic Semiconductor Devices.
 4590 Patrick Henry Drive • Santa Clara, CA 95054-1817 • (408) 988-3500 • FAX (408) 988-0279 • www.cel.com

DATA SUBJECT TO CHANGE WITHOUT NOTICE

09/10/2003