

TOSHIBA TRANSISTOR SILICON NPN EPITAXIAL PLANAR TYPE

2SC4324

VHF~UHF BAND LOW NOISE AMPLIFIER APPLICATIONS

Unit in mm

- Low Noise Figure, High Gain.
- $NF = 1.8\text{dB}$, $|S_{21e}|^2 = 9.5\text{dB}$ ($f = 2\text{GHz}$)

MAXIMUM RATINGS ($T_a = 25^\circ\text{C}$)

CHARACTERISTIC	SYMBOL	RATING	UNIT
Collector-Base Voltage	V_{CBO}	20	V
Collector-Emitter Voltage	V_{CEO}	10	V
Emitter-Base Voltage	V_{EBO}	1.5	V
Base Current	I_B	7	mA
Collector Current	I_C	15	mA
Collector Power Dissipation	P_C	150	mW
Junction Temperature	T_j	125	$^\circ\text{C}$
Storage Temperature Range	T_{stg}	-55~125	$^\circ\text{C}$

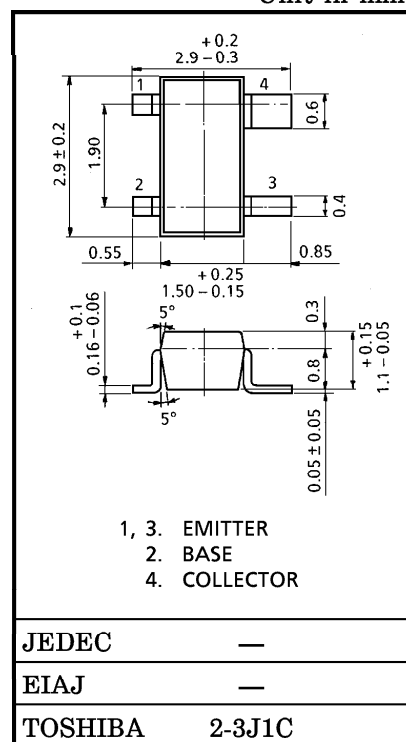

Weight : 0.012g

Marking

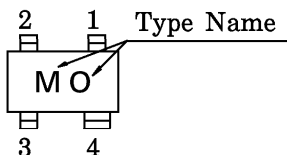

MICROWAVE CHARACTERISTICS ($T_a = 25^\circ\text{C}$)

CHARACTERISTIC	SYMBOL	TEST CONDITION	MIN.	TYP.	MAX.	UNIT
Transition Frequency	f_T	$V_{CE} = 6\text{V}$, $I_C = 7\text{mA}$	7	10	—	GHz
Insertion Gain	$ S_{21e} ^2 (1)$	$V_{CE} = 6\text{V}$, $I_C = 7\text{mA}$, $f = 1\text{GHz}$	—	15	—	dB
	$ S_{21e} ^2 (2)$	$V_{CE} = 6\text{V}$, $I_C = 7\text{mA}$, $f = 2\text{GHz}$	6.5	9.5	—	
Noise Figure	NF (1)	$V_{CE} = 6\text{V}$, $I_C = 3\text{mA}$, $f = 1\text{GHz}$	—	1.4	—	dB
	NF (2)	$V_{CE} = 6\text{V}$, $I_C = 3\text{mA}$, $f = 2\text{GHz}$	—	1.8	3.0	

ELECTRICAL CHARACTERISTICS ($T_a = 25^\circ\text{C}$)

CHARACTERISTIC	SYMBOL	TEST CONDITION	MIN.	TYP.	MAX.	UNIT
Collector Cut-off Current	I_{CBO}	$V_{CB} = 10\text{V}$, $I_E = 0$	—	—	1	μA
Emitter Cut-off Current	I_{EBO}	$V_{EB} = 1\text{V}$, $I_C = 0$	—	—	1	μA
DC Current Gain	h_{FE}	$V_{CE} = 6\text{V}$, $I_C = 7\text{mA}$	50	—	250	—
Output Capacitance	C_{ob}	$V_{CB} = 10\text{V}$, $I_E = 0$, $f = 1\text{MHz}$	—	0.55	—	pF
Reverse Transfer Capacitance	C_{re}	(Note)	—	0.35	0.8	pF

(Note) C_{re} is measured by 3 terminal method with Capacitance Bridge.

961001EAA2

- TOSHIBA is continually working to improve the quality and the reliability of its products. Nevertheless, semiconductor devices in general can malfunction or fail due to their inherent electrical sensitivity and vulnerability to physical stress. It is the responsibility of the buyer, when utilizing TOSHIBA products, to observe standards of safety, and to avoid situations in which a malfunction or failure of a TOSHIBA product could cause loss of human life, bodily injury or damage to property. In developing your designs, please ensure that TOSHIBA products are used within specified operating ranges as set forth in the most recent products specifications. Also, please keep in mind the precautions and conditions set forth in the TOSHIBA Semiconductor Reliability Handbook.
- The information contained herein is presented only as a guide for the applications of our products. No responsibility is assumed by TOSHIBA CORPORATION for any infringements of intellectual property or other rights of the third parties which may result from its use. No license is granted by implication or otherwise under any intellectual property or other rights of TOSHIBA CORPORATION or others.
- The information contained herein is subject to change without notice.

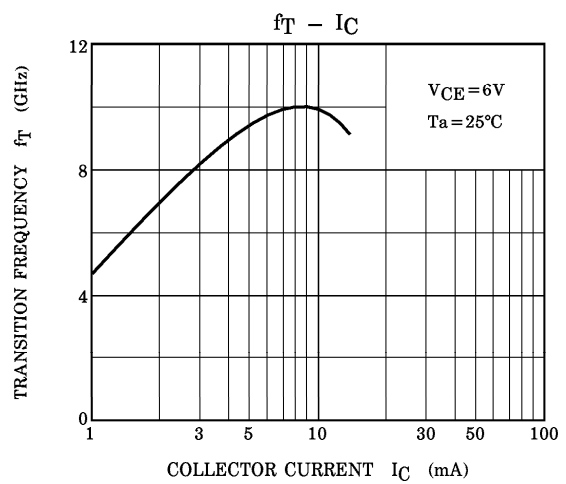
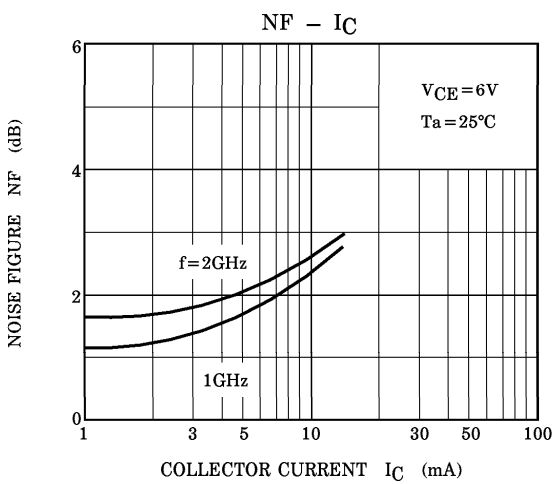
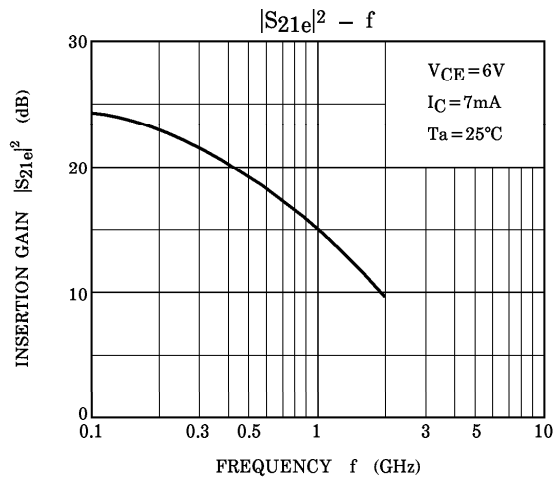
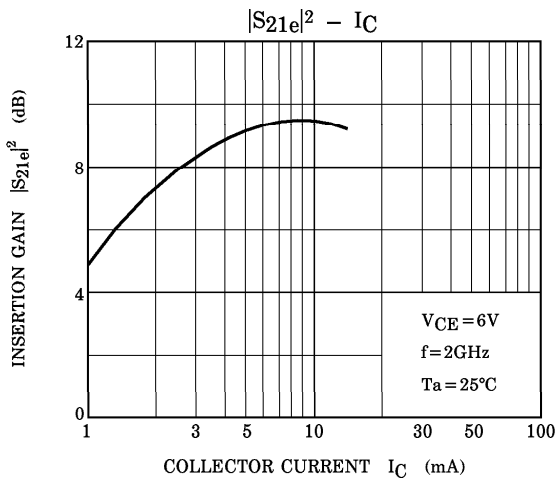
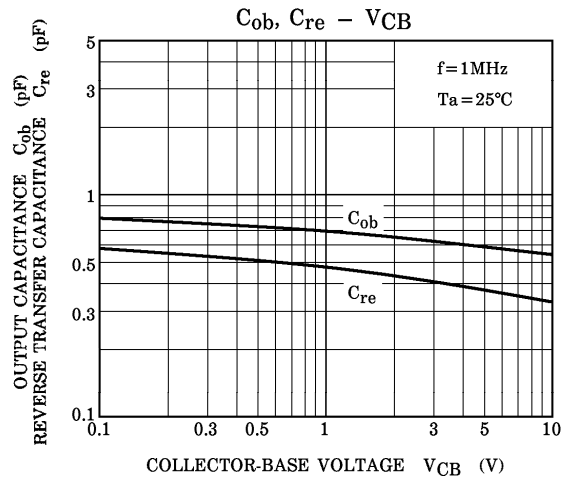
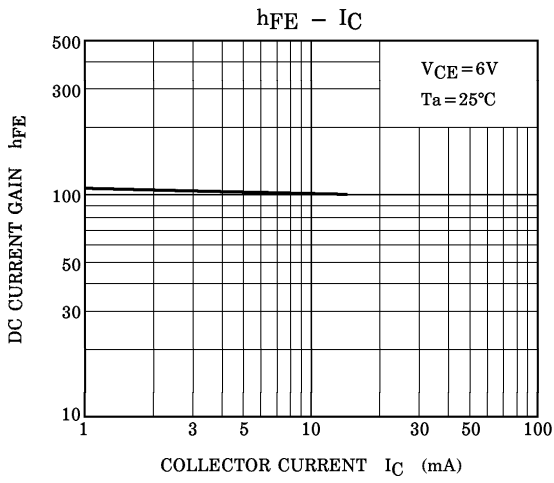

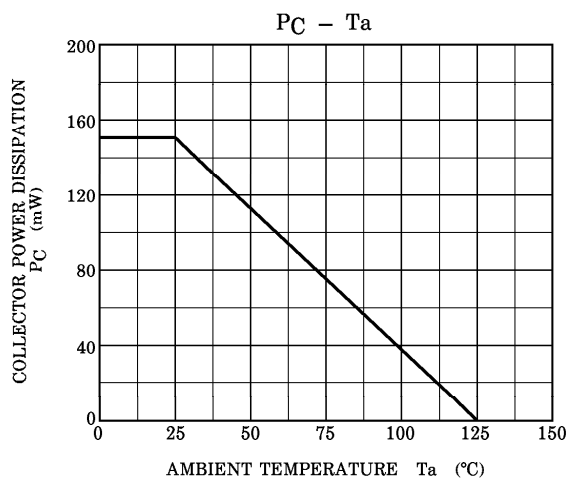
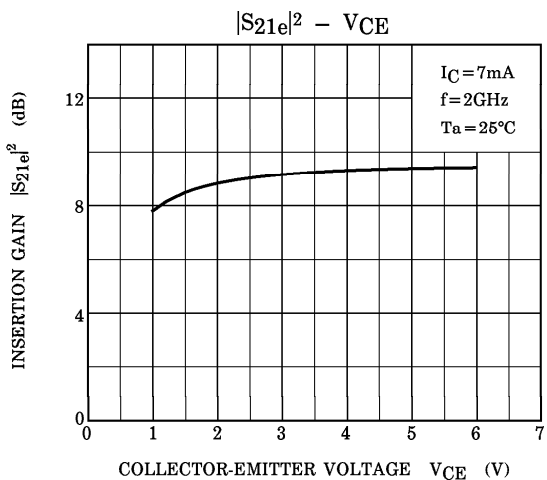

S-PARAMETER Z_O = 50Ω, Ta = 25°C
V_{CE} = 6V, I_C = 3mA

FREQUENCY MHz	S11		S21		S12		S22	
	MAG	ANG	MAG	ANG	MAG	ANG	MAG	ANG
200	0.831	-26.6	7.776	156.8	0.042	74.0	0.939	-19.5
400	0.719	-50.1	6.775	139.2	0.074	61.6	0.833	-35.5
600	0.618	-70.8	5.857	125.4	0.097	52.5	0.724	-48.1
800	0.515	-88.5	5.063	113.9	0.111	46.5	0.627	-58.0
1000	0.434	-104.0	4.381	105.3	0.122	42.3	0.553	-65.6
1200	0.374	-119.2	3.886	97.2	0.130	39.6	0.495	-71.6
1400	0.332	-134.7	3.425	89.8	0.137	37.8	0.453	-76.1
1600	0.293	-147.5	3.135	84.4	0.145	36.5	0.423	-81.0
1800	0.267	-163.2	2.926	78.2	0.150	35.8	0.397	-85.1
2000	0.248	-175.3	2.709	73.7	0.157	35.7	0.382	-89.4

V_{CE} = 6V, I_C = 7mA

FREQUENCY MHz	S11		S21		S12		S22	
	MAG	ANG	MAG	ANG	MAG	ANG	MAG	ANG
200	0.683	-43.5	13.639	148.7	0.037	68.4	0.876	-27.8
400	0.541	-78.5	10.619	126.8	0.060	55.8	0.688	-46.4
600	0.437	-105.5	8.350	112.6	0.072	49.8	0.547	-57.7
800	0.365	-128.4	6.752	102.1	0.082	47.6	0.447	-65.1
1000	0.319	-148.8	5.640	94.4	0.090	47.0	0.383	-70.0
1200	0.293	-166.3	4.877	87.5	0.098	47.1	0.338	-73.3
1400	0.280	174.4	4.248	81.3	0.107	46.9	0.308	-75.4
1600	0.269	162.3	3.813	76.4	0.116	47.4	0.292	-78.0
1800	0.272	148.6	3.489	70.8	0.124	47.5	0.283	-80.3
2000	0.264	137.2	3.182	66.5	0.134	47.6	0.278	-83.7

S_{11e}
 V_{CE} = 6V
 I_C = 3mA
 T_a = 25°C
 (UNIT : Ω)

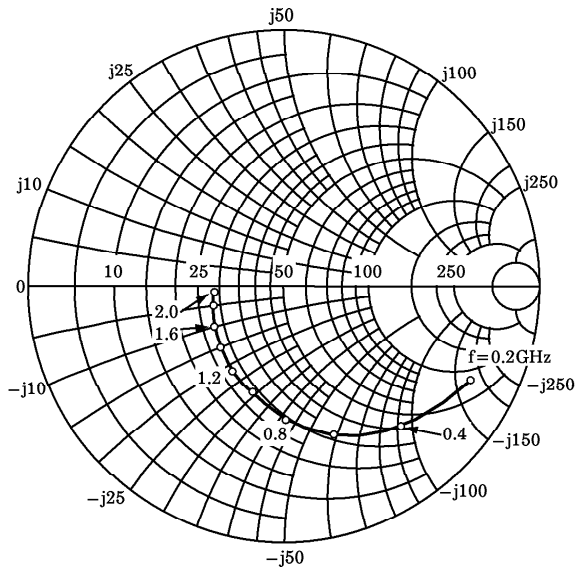

S_{21e}
 V_{CE} = 6V
 I_C = 3mA
 T_a = 25°C

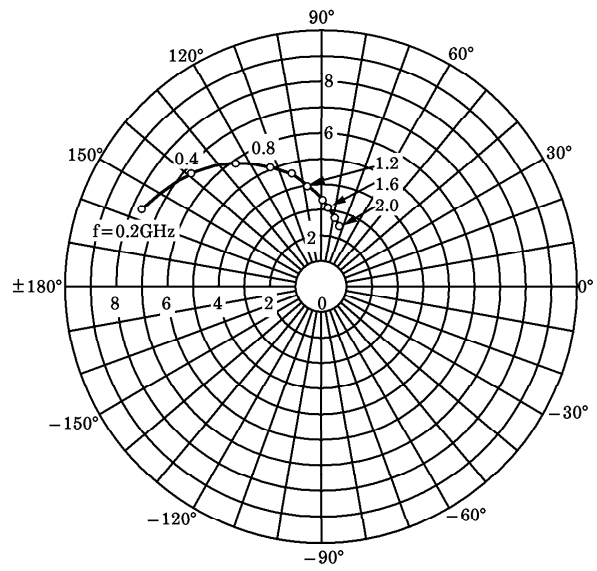

S_{12e}
 V_{CE} = 6V
 I_C = 3mA
 T_a = 25°C

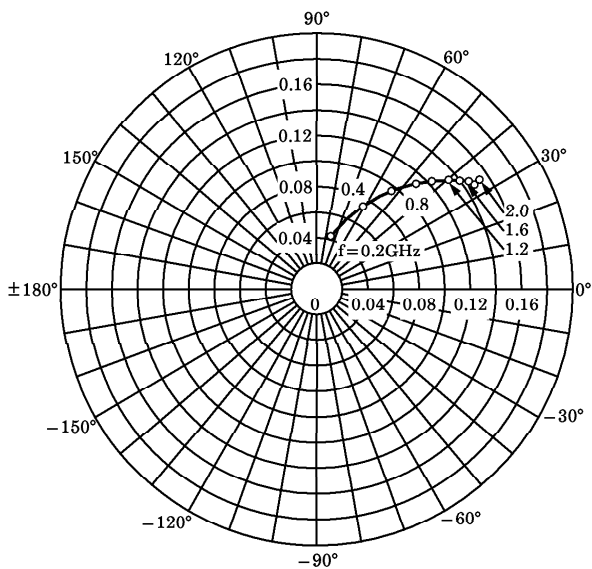

S_{22e}
 V_{CE} = 6V
 I_C = 3mA
 T_a = 25°C
 (UNIT : Ω)

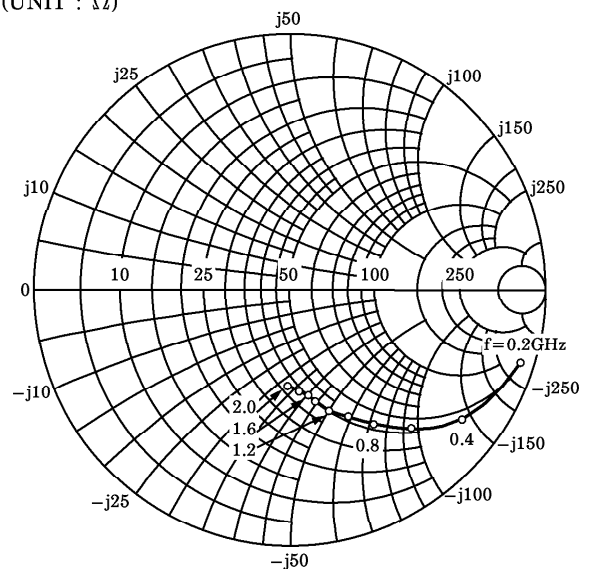

S_{11e}
 $V_{CE} = 6V$
 $I_C = 7mA$
 $T_a = 25^\circ C$
 (UNIT : Ω)

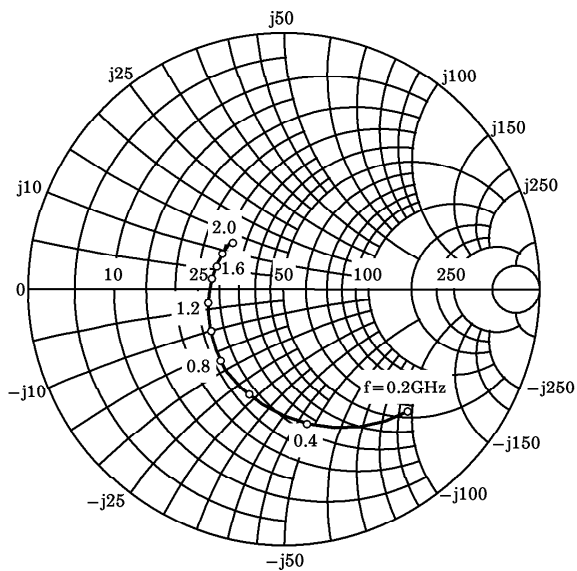

S_{21e}
 $V_{CE} = 6V$
 $I_C = 7mA$
 $T_a = 25^\circ C$

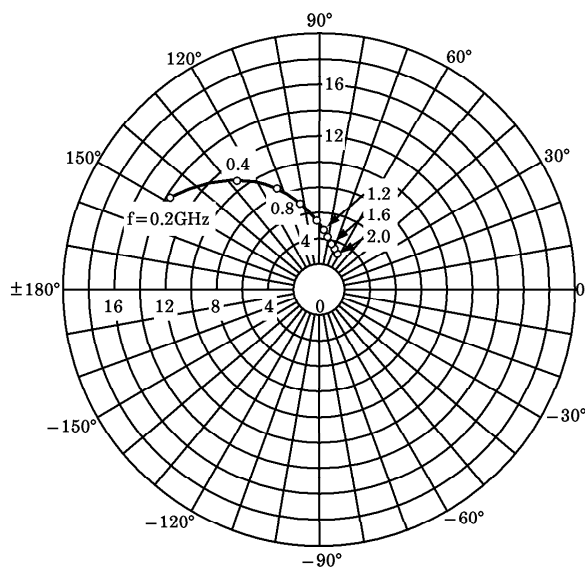

S_{12e}
 $V_{CE} = 6V$
 $I_C = 7mA$
 $T_a = 25^\circ C$

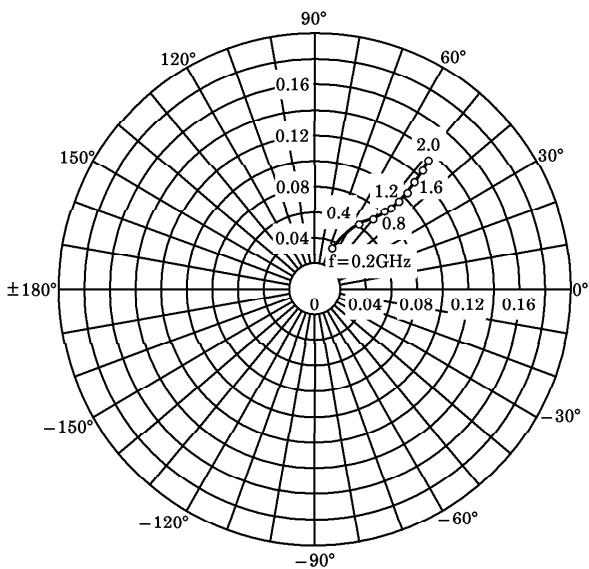

S_{22e}
 $V_{CE} = 6V$
 $I_C = 7mA$
 $T_a = 25^\circ C$
 (UNIT : Ω)

