

# PRECISION 5.0 VOLT MICROPOWER VOLTAGE REFERENCE

ISSUE 1 - OCTOBER 1995

ZRB500

## DEVICE DESCRIPTION

The ZRB500 uses a bandgap circuit design to achieve a precision micropower voltage reference of 5.0 volts. The device is available in small outline surface mount packages, ideal for applications where space saving is important, as well as packages for through hole requirements.

The ZRB500 design provides a stable voltage without an external capacitor and is stable with capacitive loads. The ZRB500 is recommended for operation between  $50\mu\text{A}$  and  $15\text{mA}$  and so is ideally suited to low power and battery powered applications.

Excellent performance is maintained to a suggested absolute maximum of  $25\text{mA}$ , however the rugged design and 20 volt processing allows the reference to withstand transient effects and currents up to  $200\text{mA}$ . Superior switching capability allows the device to reach stable operating conditions in only a few microseconds.

## FEATURES

- Small outline SOT23,SO8 and TO92 style packages
- No stabilising capacitor required
- Typical  $T_C$  15ppm/°C
- Typical slope resistance  $0.33\Omega$
- $\pm 3\%$ ,  $2\%$  and  $1\%$  tolerance
- Industrial temperature range
- Operating current  $50\mu\text{A}$  to  $15\text{mA}$
- Transient response, stable in less than  $10\mu\text{s}$
- **APPLICATIONS**
- Battery powered and portable equipment.
- Metering and measurement systems.
- Instrumentation.
- Test equipment.
- Data acquisition systems.
- Precision power supplies.

## SCHEMATIC DIAGRAM

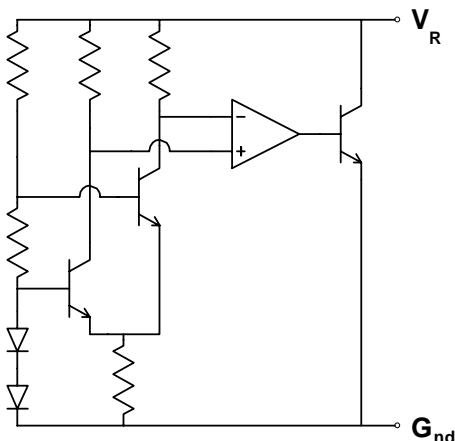

# ZRB500

## ABSOLUTE MAXIMUM RATING

Reverse Current	25mA
Forward Current	25mA
Operating Temperature	-40 to 85°C
Storage Temperature	-55 to 125°C

## Power Dissipation (T<sub>amb</sub>=25°C)

SOT23	330mW
E-Line, 3 pin (TO92)	500mW
E-Line, 2 pin (TO92)	500mW
SO8	625mW

## ELECTRICAL CHARACTERISTICS

### TEST CONDITIONS (Unless otherwise stated) T<sub>amb</sub>=25°C

SYMBOL	PARAMETER	CONDITIONS	LIMITS			TOL. %	UNITS
			MIN	TYP	MAX		
V <sub>R</sub>	Reverse Breakdown Voltage	I <sub>R</sub> =150μA	4.95 4.90 4.85	5.0 5.0 5.0	5.05 5.10 5.15	1 2 3	V
I <sub>MIN</sub>	Minimum Operating Current			30	50		μA
I <sub>R</sub>	Recommended Operating Current		0.05		15		mA
T <sub>C</sub> †	Average Reverse Breakdown Voltage Temp. Co.	I <sub>R(min)</sub> to I <sub>R(max)</sub>		15	50		ppm/°C
R <sub>S</sub> §	Slope Resistance			0.33	1.5		Ω
Z <sub>R</sub>	Reverse Dynamic Impedance	I <sub>R</sub> = 1mA f = 100Hz I <sub>AC</sub> = 0.1 I <sub>R</sub>		0.4	1		Ω
E <sub>N</sub>	Wideband Noise Voltage	I <sub>R</sub> = 150μA f = 10Hz to 10kHz		100			μV(rms)

$$† T_C = \frac{V_R \text{ Change} \times 1000000}{V_R \times \text{Temperature Change}}$$

$$§ R_S = \frac{V_R \text{ Change}(I_R(\text{min}) \text{ to } I_R(\text{max}))}{I_R(\text{max}) - I_R(\text{min})}$$

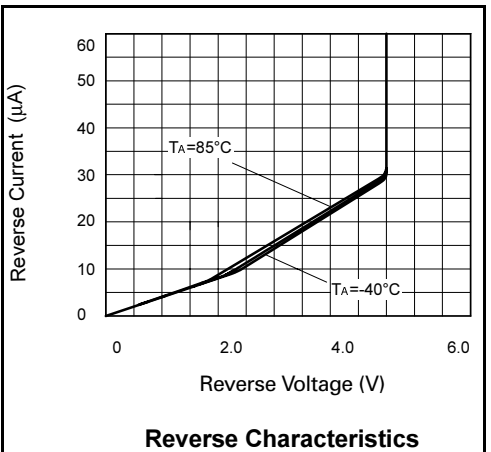

# ZRB500

## TYPICAL CHARACTERISTICS

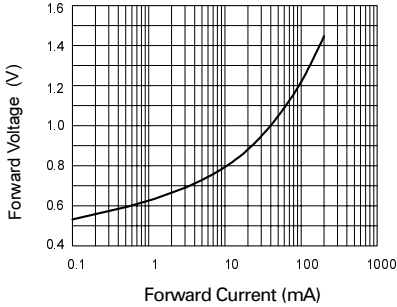

**Forward Characteristics**

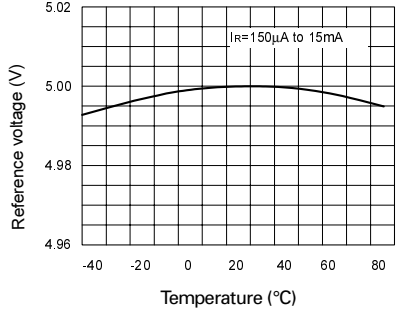

**Temperature Drift**

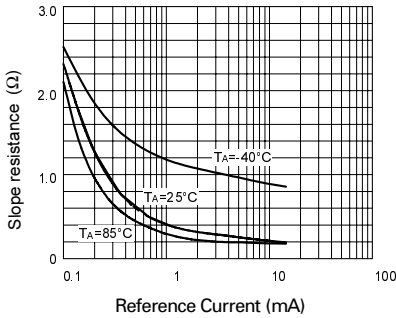

**Slope Resistance v Current**

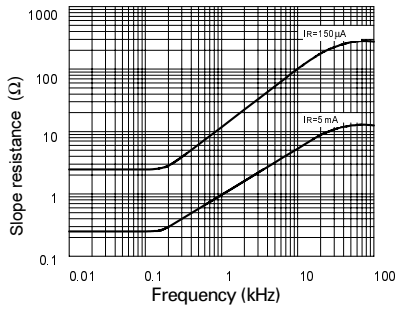

**Slope Resistance v Frequency**

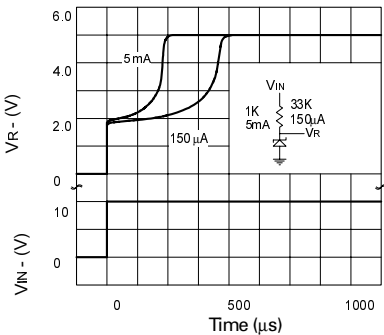

**Transient Response  
(Single Pulse)**

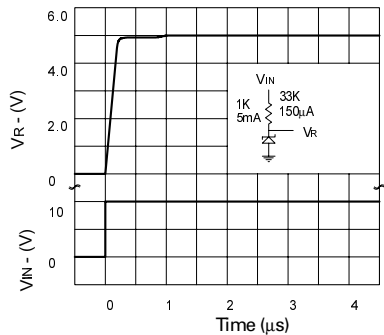

**Transient Response  
(Repetitive Pulse)**

# ZRB500

## CONNECTION DIAGRAMS

### E-Line, 2 pin Package Suffix – Y

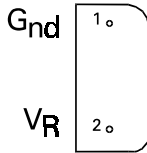

Bottom View

### E-Line, 3 pin, Rev Package Suffix – R

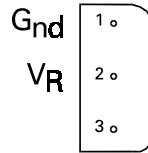

Bottom View –  
Pin 3 floating or connected to pin 1

### E-Line, 3 pin Package Suffix – A

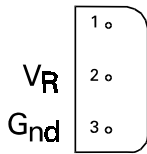

Bottom View –  
Pin 1 floating or connected to pin 3

### SO8 Package Suffix – N8

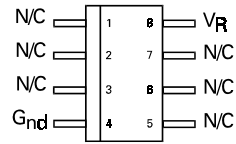

Top View

### SOT23 Package Suffix – F

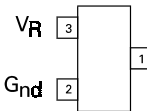

Top View –  
Pin 1 floating or connected to pin 2

# ZRB500

## ORDERING INFORMATION

Part No	Tol%	Package	Partmark
ZRB500A03	3	E-Line •	ZRB50003
ZRB500A02	2	E-Line •	ZRB50002
ZRB500A01	1	E-Line •	ZRB50001
ZRB500F03	3	SOT23	50G
ZRB500F02	2	SOT23	50H
ZRB500F01	1	SOT23	50I
ZRB500N803	3	SO8	ZRB50003
ZRB500N802	2	SO8	ZRB50002
ZRB500N801	1	SO8	ZRB50001

Part No	Tol%	Package	Partmark
ZRB500R03	3	E-Line *	ZRB500R3
ZRB500R02	2	E-Line *	ZRB500R2
ZRB500R01	1	E-Line *	ZRB500R1
ZRB500Y03	3	E-Line †	ZRB50003
ZRB500Y02	2	E-Line †	ZRB50002
ZRB500Y01	1	E-Line †	ZRB50001

\* E-Line 3 pin Reversed  
† E-Line 2 pin  
• E-Line 3 pin