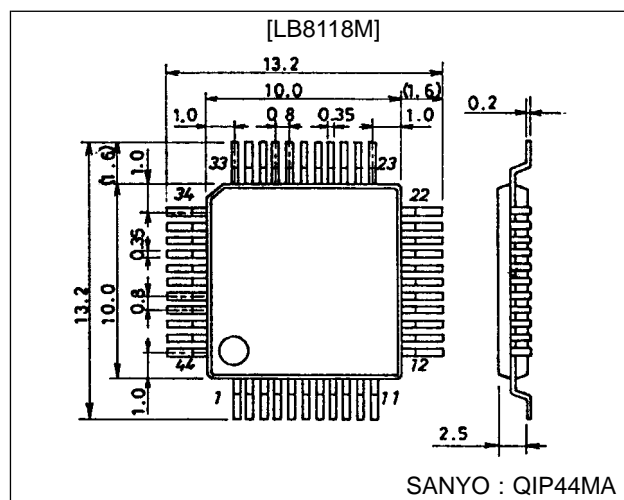

SANYO**LB8118M****Actuator Driver for Portable CD Players****Preliminary****Overview**

The LB8118M is an actuator driver IC designed for portable CD players that operate at 2.4 V (two Ni-Cd batteries) or 3.0 V (two dry cells). Because the four-channel driver control outputs are divided into two groups, this device reduces power dissipation considerably during double-speed play.

Package Dimensions

unit : mm

3148-QFP44MA**Functions and Features**

- H bridge drivers (output dynamic range maximum is about 2 V) on chip for four channels to drive each CD actuator (the focus coil, the tracking coil, the spindle motor, and the sled motor).
- Step-up circuit (voltage to be set by an external resistor) on chip that is used to apply voltage to the CD DSP, ASP and microcontroller. Center-tap coil for step-up circuit makes it possible to supply the driver control voltage. (However, the drive Tr, L, C, and Di are all external.)
- Oscillator circuits for each converter on chip. (C is external.)
- Four-channel driver control output is divided into two groups (the focus/tracking group and the spindle/sled group) for minimum loss at double-speed playback. Highest operating voltage detected in each group is supplied for each 2ch H bridge driver after PMW conversion. The single channel PWM drive without dividing the outputs into two groups is also possible. (However, the PWM PNP-Tr, NPN-Tr, L, C, and Di are all external.)
- The dynamic range of 4-channel H bridge driver output voltage is up to 2 V on the focus and tracking side, and can be set by the Vosat pin on the spindle and sled side. However, if the 4-channel H bridge voltages in the H bridge driver block are the same, the maximum voltage is determined using the Voset pin.
- Sled motor driving mode is switchable between step drive mode for lower power dissipation, and normal V-type drive mode. (The other three channels are fixed to V-type.)
- In the spindle motor drive circuit, the control gain can be set higher for double-speed playback.
- PWM step-down circuit for external power operates when external power (4 V or higher) is supplied. In this function, external power is converted to V_{CC} power supply, and two type voltage setting is possible. In playback mode, step-up voltage for DSP has to be set equal to or lower than V_{CC} , but in charging the battery, it has to be set higher enough than V_{CC} . So step-down voltage (V_{CC}) setting of two types is possible with two pairs of external resistor. (Switching port is provided.) (However, the PWM PNP-Tr, NPN-Tr, L, C, and Di are all external.)
- APC step-up power supply for the laser diode. (Also supports a pre-power supply for the internal bias.) The laser diode is controlled with a voltage of roughly 0.5 V.
- Battery pulse charging function on chip. (However, the drive NPN-Tr, and the current feedback C and R are external.)
- Battery check comparator on chip.
- The system can be started up and stopped by outputs from the microcontroller.
- Actuator muting function on chip (for all four channels simultaneously).
- Thermal shutdown circuit on chip.

Specifications

Absolute Maximum Ratings at $T_a = 25^\circ\text{C}$

Parameter	Symbol	Conditions	Ratings	Unit
Maximum supply voltage	V_{CCmax}		7	V
V_{CD} pin input voltage	V_{CDmax}		10	V
H bridge output current	I_{OUTmax}	Maximum per channel is 400 mA.	800	mA
Allowable power dissipation	$Pd\ max$	Independent IC	700	mW
Operating temperature	T_{opr}		-20 to +75	$^\circ\text{C}$
Storage temperature	T_{stg}		-55 to +150	$^\circ\text{C}$

Allowable Operating Ranges at $T_a = 25^\circ\text{C}$

Parameter	Symbol	Conditions	Ratings	Unit
Supply voltage	V_{CC}		1.6 to 5.0	V
V_{CD} pin input voltage	V_{CD}		3.6 to 9.0	V
V_{CC} drop setting voltage when external voltage input is applied	$V_{CC(EXT)}$		3.0 to 5.0	V
H Bridge limiter voltage	$V_H\ lim$		0.15 to 2.25	V

Electrical Characteristics at $T_a = 25^\circ\text{C}$, $V_{CC} = 3\text{ V}$, $V_{CD} = 4\text{ V}$

Parameter	Symbol	Conditions	min	typ	max	Unit
[Power Supply Block]						
Standby current drain	I_{CCO}	S/S = [H], the total of V_{CC} and V_{CD}			100	μA
V_{CC} quiescent current drain	I_{CC}	S/S = [L], V_{CC} line only		11.0		mA
V_{CD} quiescent current drain	I_{CD}	S/S = [L], with no driver input		4.0		mA
[ASP step-up circuit]						
ASP drive output current	$I_{O\ ASPDRV}$			2.0		mA
V_{ASP} pin input bias current	$I_B\ VASP$				200	nA
ASPBASE pin saturation voltage	$V_O\ ASPBASE$	$I_O = 1\ \text{mA}$			0.2	V
Load regulation	$R_{LD\ ASP}$	$V_{ASP} = 3.4\ \text{V}$, $L = 30\ \mu\text{H}$, $C = 220\ \mu\text{F}$			1000	mV/A
Line regulation	$R_{LN\ ASP}$	$V_{ASP} = 3.4\ \text{V}$, $L = 30\ \mu\text{H}$, $C = 220\ \mu\text{F}$			100	mV/V
Minimum off duty	$D_{min\ ASP}$			50		%
[APC step-up circuit]						
APC drive output current	$I_{O\ APCDRV}$			0.5		mA
V_{APC} pin input bias current	$I_B\ VAPC$				200	nA
$V_{APC} - V_{LD}$ voltage	$V_{APC} - LD$			0.5		V
Load regulation	$R_{LD\ APC}$	$V_{APC} = 3.4\ \text{V}$, $L = 30\ \mu\text{H}$, $C = 220\ \mu\text{F}$			1000	mV/A
Line regulation	$R_{LN\ APC}$	$V_{APC} = 3.4\ \text{V}$, $L = 30\ \mu\text{H}$, $C = 220\ \mu\text{F}$			100	mV/V
Minimum off duty	$D_{min\ APC}$			50		%
[H Bridge Output Block, PWM Block]						
Output saturation voltage	$V_H\ sat$	$I_O = 200\ \text{mA}$, TOP + BOTTOM		0.30	0.45	V
Maximum output voltage	$V_{PWM\ max}$	$V_{OUT\ 1}$		2.25		V
PWM applied offset voltage	V_{PWMOFF}	Each $V_{IN} = V_{ASPREF}$		0.17		V
DNB - 1,2 pins output current	$I_O\ DNB1,2$			$V_{OUT}/60$		mA
Load regulation	$R_{LD\ PWM}$	$V_{OUT} = 2.25\ \text{V}$, $L = 30\ \mu\text{H}$			1000	mV/A
Line regulation	$R_{LN\ PWM}$	$V_{OUT} = 2.25\ \text{V}$, $L = 30\ \mu\text{H}$			100	mV/V
[Drive Control Block]						
CH1 to 4 input voltage range	V_{IN1-4}		0.5		$V_{CD}-0.5$	V
Input bias current	$I_B\ IN$	Each $V_{IN} = V_{ASPREF}$			2.0	μA
ASP REF input voltage range	V_{ASPR}	Each $V_{IN} = V_{ASPREF}$	1.2		$V_{CD}-1.3$	V
CH1,2,4 transfer gain	G_{124IN}	$R_L = 10\ \Omega$		7.95		dB
CH3 L side transfer gain	G_{3LIN}	$R_L = 10\ \Omega$		10.0		dB
Negative/positive transfer gain difference	ΔG_{IN}	$R_L = 10\ \Omega$	-1.0	0	+1.0	dB
Input dead zone voltage range	V_{DZ}	$R_L = 10\ \Omega$	0	0	30	mV

Continued on next page.

LB8118M

Continued from preceding page.

Parameter	Symbol	Conditions	min	typ	max	Unit
[SLED Drive Circuit]						
SL REF pin input voltage range	$V_{SL\ REF}$		$V_{ASP\ REF}+0.1$		$V_{CD}-1.0$	V
SL REF pin input bias current	$I_{B\ SL\ REF}$				200	nA
Positive side setting offset voltage between IN4 and SL REF	$V_{off\ SL\ REF}$	$V_{SL\ REF} = 2.3\ V, V_{ASP\ REF} = 2\ V$	-20		+20	mV
Dual side step width difference voltage	$V_{SL\ DIF}$	$V_{SL\ REF} = 2.3\ V, V_{ASP\ REF} = 2\ V$	-20		+25	mV
SL MODE pin high voltage	$V_{H\ SL\ MODE}$		2.0			V
SL MODE pin low voltage	$V_{L\ SL\ MODE}$		-25		+1.0	V
[OSC Block]						
Maximum oscillation frequency	$F_{OSC\ max}$				100	kHz
Input bias current	$I_{B\ OSC}$		-2.0			μ A
[S/S Pin Function]						
S/S start voltage	V_{SSON}				$V_{CC}-1.0$	V
S/S off voltage	V_{SSOFF}		0.5			V
[External Voltage Input Block]						
Minimum operating input voltage when external voltage input is applied	$V_{EXT\ min}$	$R_{IN} = 1\ k\Omega$	3.5			V
EXTDRV pin output current	$I_{O\ EXT\ DRV}$			200		μ A
VZ pin voltage	V_Z	$V_{EXT} = 4.5\ V, R_{IN} = 1\ k\Omega$		3.0		V
VZ pin inflow current	I_{VZ}				20	mA
$V_{EXT}, V_{EXT-CHG}$ pin input bias current	$I_{B\ EXTCHG}$ $I_{B\ EXT}$				200	nA
EXTBASE pin saturation voltage	$V_{EXTBASE}$	$I_O = 1\ mA$			0.2	V
[Muting Block]						
Mute on voltage	$V_{ON\ MUTE}$				1.0	V
Mute off voltage	$V_{OFF\ MUTE}$		2.0			V
[Pulse Charging Function]						
Internal reference voltage	$V_{CHG\ REF}$			0.3		V
CHG-ON pin ON voltage	V_{CHG-ON}		2.0			V
CHG-ON Pin OFF voltage	$V_{CHG-OFF}$				1.0	V
CHG-MON pin input bias current	$I_{B\ CHG\ MON}$				200	nA
CHGDRV pin output current	$I_{O\ CHG\ DRV}$			3.0		mA
[H Bridge 1-channel/2-channel drive switch]						
1-channel/2-channel switching, 2-channel on voltage	$V_L\ 1ch/2ch$				1.0	V
1-channel/2-channel switching, 1-channel on voltage	$V_H\ 1ch/2ch$		2.0			V
[TSD Block]						
Operating temperature	T_{TSD}	Design target value, Note 1		180		$^{\circ}$ C
Temperature hysteresis width	ΔT_{TSD}	Design target value, Note 1		20		$^{\circ}$ C
[Battery Check Block]						
Input bias current	I_{BIN}				200	nA
Output saturation voltage	V_{BO}	$I_O = 100\ \mu A$			0.3	V

Note 1: For parameters which have an entry of “design target value” in the “Conditions” column, no measurements are made.

LB8118M

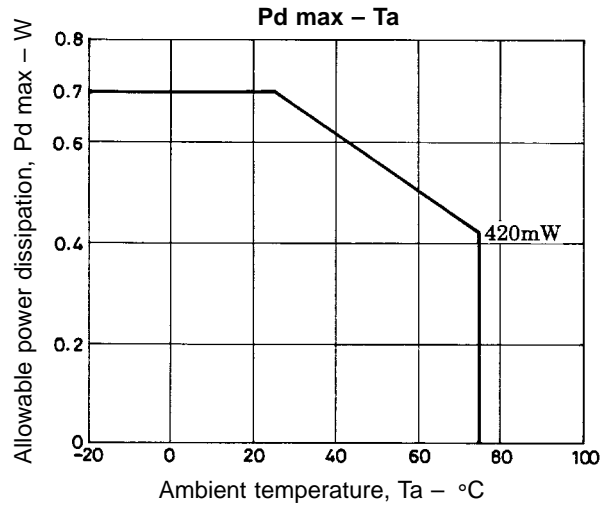

Pin Assignment

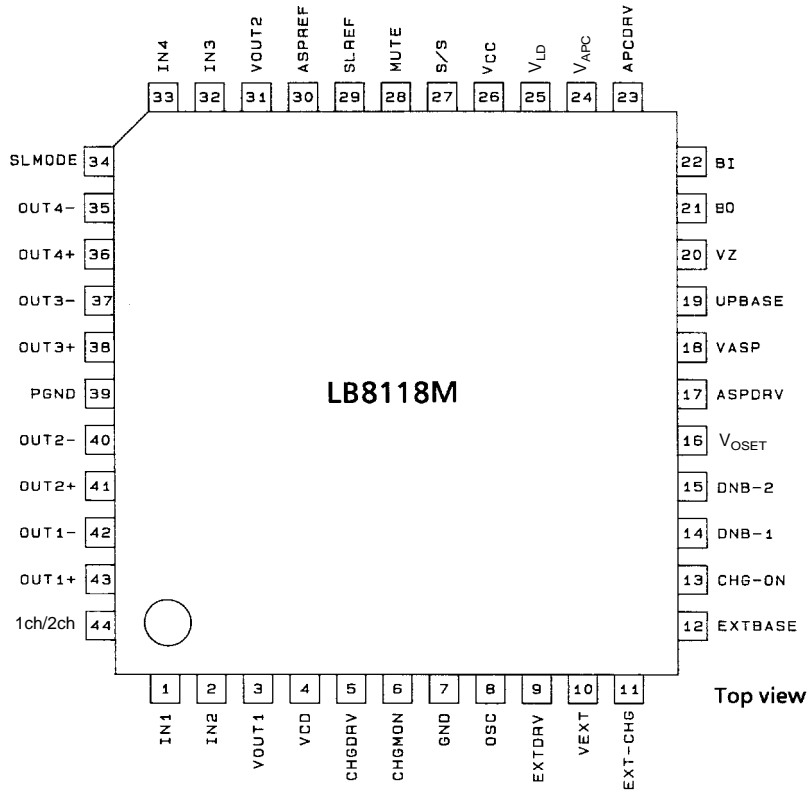

A04655

LB8118M

Pin Functions

Pin No.	Symbol	Equivalent circuit	Function
1, 2 32, 33	IN1, IN2 IN3, IN4		<p>Actuator control signals for each driver: IN1: Focus, IN2: Tracking, IN3: Spindle, IN4: Sled. These signals are input from the ASP (DSP).</p>
30	ASP _{REF}		Control reference signal input pin for each driver. This signal is input from the ASP (DSP).
43, 42 41, 40 38, 37 36, 35	OUT1 ⁺ , 1 ⁻ OUT2 ⁺ , 2 ⁻ OUT3 ⁺ , 3 ⁻ OUT4 ⁺ , 4 ⁻		<p>Focus coil actuator drive output pins. Tracking coil actuator drive output pins. Spindle motor drive output pins. Sled motor drive output pins. (Each channel includes built-in spark killer diodes.)</p>
3 31	V _{OUT1} V _{OUT2}		<p>Power supply pins for the H bridge driver. V_{OUT1} is for the focus/tracking group and V_{OUT2} is for the spindle/sled group. Maximum value + α (α : saturation voltage of upper/lower output Tr) of each 2-channel control output is set by external PWM step-down circuit.</p>
4	V _{CD}		Power supply for the actuator driver controller, maximum value circuit for PWM, and sled controller.
5	CHGDRV		Base drive output pin for the external NPN-Tr for the battery pulse charging circuit.
9	EXTDRV		Base drive output pin for the external step-down NPN-Tr used when external voltage input is applied.
14	DNB-1		Base drive output pin for the PNP-Tr for the step-down PWM that generates the power supply for the H bridge driver that drives the focus/tracking group actuators. (Open when there is one H bridge power supply.)
15	DNB-2		Base drive output pin for the PNP-Tr for the step-down PWM that generates the power supply for the H bridge driver that drives the spindle/sled group actuators. (DNB-2 becomes the drive pin when there is one H bridge power supply.)
17	ASPDRV		Base drive output pin for the external NPN-Tr for the step-up circuit that sets the external voltage for the DSP.
24	APCDRV		Base drive output pin for external NPNTTr for the laser diode APC power supply.

Continued on next page.

LB8118M

Continued from preceding page.

Pin No.	Symbol	Equivalent circuit	Function
6	CHG MON		Constant-current feedback input pin for the charging circuit. The charging current is determined by comparing this input voltage and the internal reference voltage (0.35 V typ.).
12	EXTBASE		Connection pin for the resistor that is used to set the voltage for the external step-down circuit. This prevents invalid current at no power supply.
7	GND		LB8118M GND pin for small-signal block. (GND except output power Tr)
8	OSC		Input pin for the free-running oscillation circuit that is used to operate the PWM step-down circuit and step-up circuit. The oscillating frequency is determined by external capacitors.
10	V _{EXT}		Voltage feedback input pin for the external power supply step-down circuit. V _{CC} for playback is set by comparing this pin voltage with the internal reference voltage (1.28 V typ.).
11	V _{EXTCHG}		Voltage feedback input pin for the external power supply step-down circuit. V _{CC} for charging is set by comparing this pin voltage with the internal reference voltage (1.28 V typ.).
18	V _{ASP}		Voltage feedback input pin for the step-up circuit. The step-up voltage is determined by comparing this pin voltage with the internal reference voltage (1.28 V typ.).
19	UPBASE		Connection pin for the resistor that is used to set the voltage of the step-up circuit. This prevents invalid current in standby mode.
20	VZ		Input pin for start-up circuit when an external voltage input is applied. The external voltage input is applied through a resistor inserted in series. The voltage is basically determined $1.2V + 2V_{BE}$; this pin has a current draining capacity up to 20 mA.
27	S/S		LB8118M start-up input. (Start on a low-level input.)

Continued on next page.

LB8118M

Continued from preceding page.

Pin No.	Symbol	Equivalent circuit	Function
23	V _{LD}		Laser diode voltage detection pin. The V _{LD} voltage +0.5 V is V _{APC} .
24	V _{APC}		Voltage feedback input pin for the APC step-up voltage circuit. The step-up power supply voltage is determined by comparing this input voltage with V _{LD} .
16	V _{oset}		H bridge power supply limiter voltage pin for the V _{OUT2} side. The voltage is limited at approximately 190% of the V _O SET voltage. The setting is made by a dividing resistor.
13	CHG-ON		Pin for selecting battery charging when external voltage input is applied. This pin is used to determine the drop voltage for the external voltage input. When low, the drop voltage set by VEXT is selected; when high, the drop voltage set by VEXT-CHG is selected.
28	MUTE		Input pin for simultaneously muting the four-channel drivers. (Low level: mute)
44	1ch/2ch		This pin is used to switch the H bridge power supply between two-channel simultaneous operation and one-channel operation. (Two-channel operation is selected when this pin is low.)
34	SLMODE		Pin for switching the sled driver between V-type control and step control. (High: V-type control; low: step control)
26	V _{CC}		Power supply voltage pin.
29 33	SLREF IN4		Threshold input pin for driving the sled motor stepwise. Both the positive and negative step levels (with positive-negative symmetry) are determined by the voltage differential between the pin voltage and the ASPREF pin voltage. (See Supplementary Explanation)
39	PGND		Output Tr. GND for the four-channel H bridge drivers. This pin is not internally connected to the small-signal system GND.

LB8118M

Continued from preceding page.

Pin No.	Symbol	Equivalent circuit	Function
21	BO		Battery check comparator output. Internal output current is 100 μ A.
22	BI		Battery check comparator input. Input bias current is 200 nA or less.

LB8118M

LB8118M Block Diagram

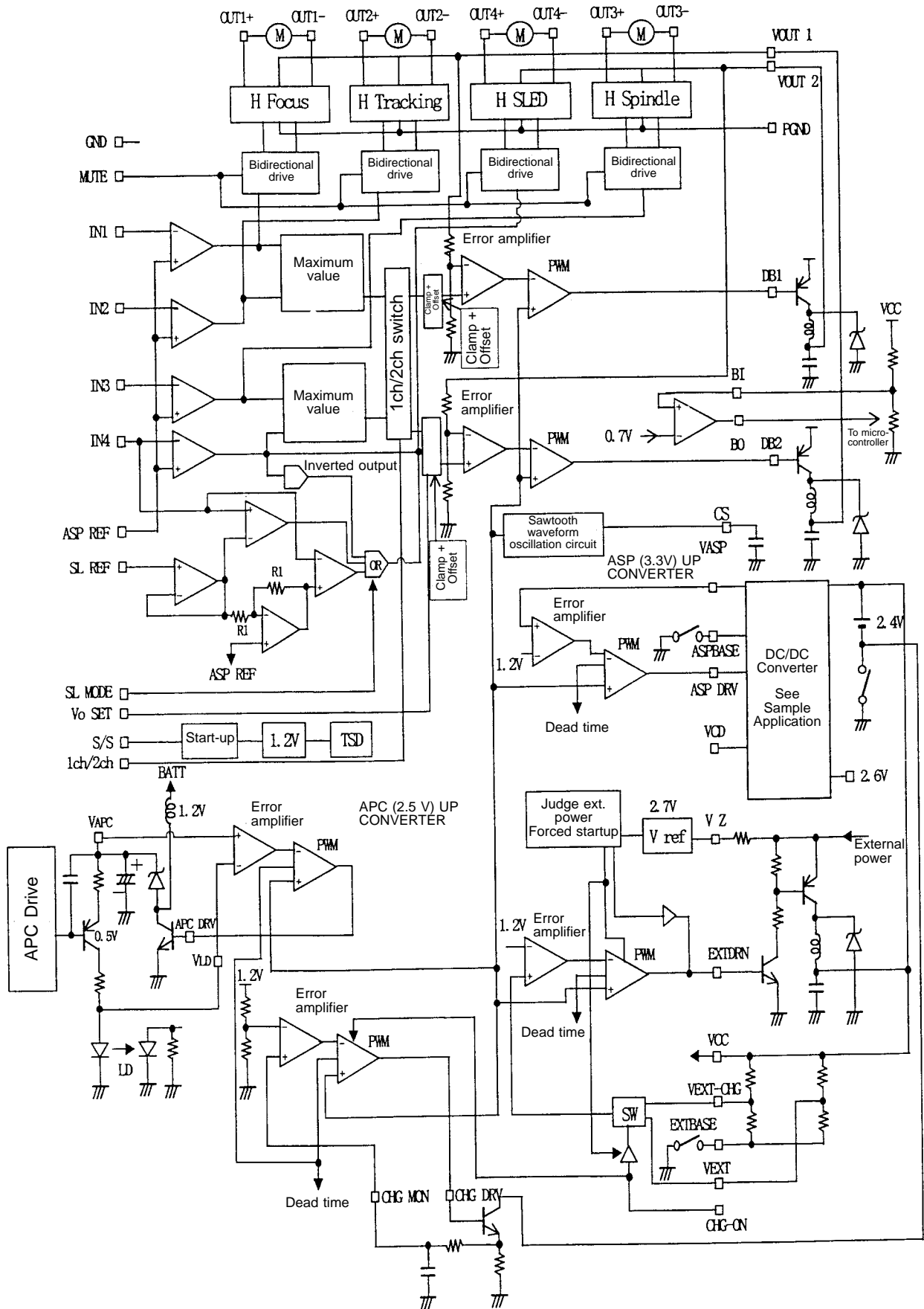

LB8118M

LB8118M Sample Application Circuit

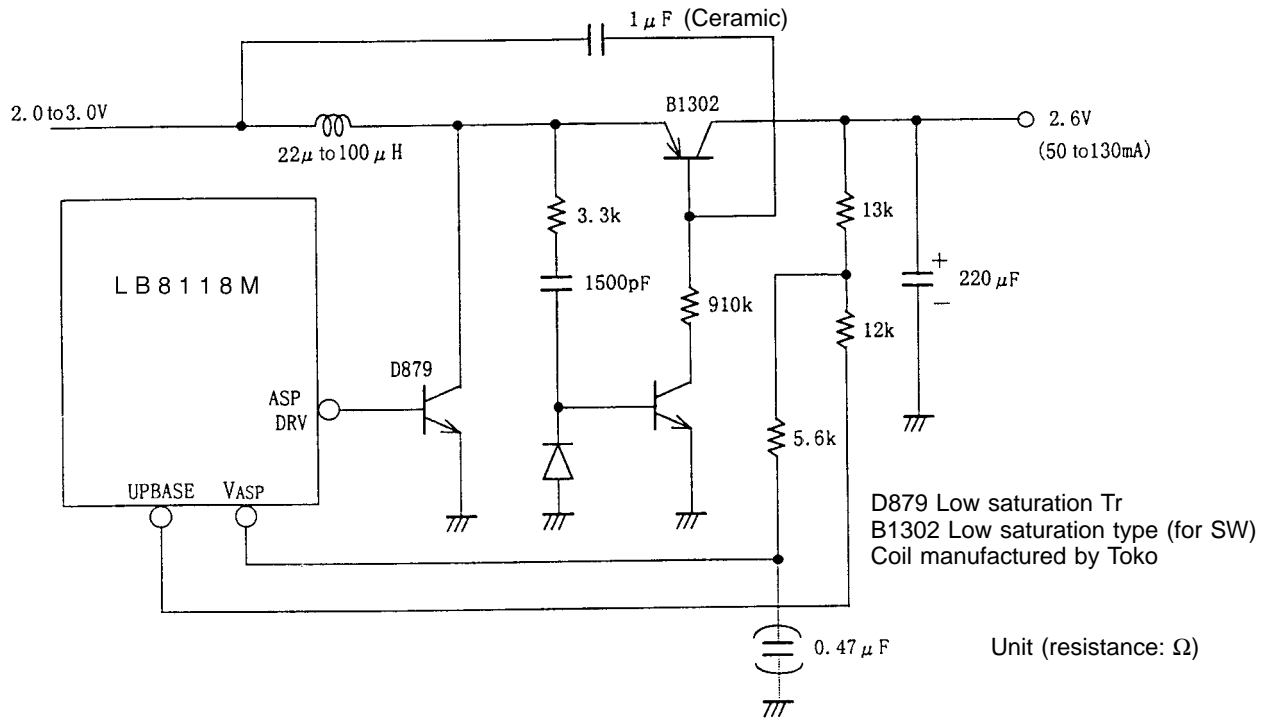

Figure 1 DC 2.6 V Up/down Sample Application

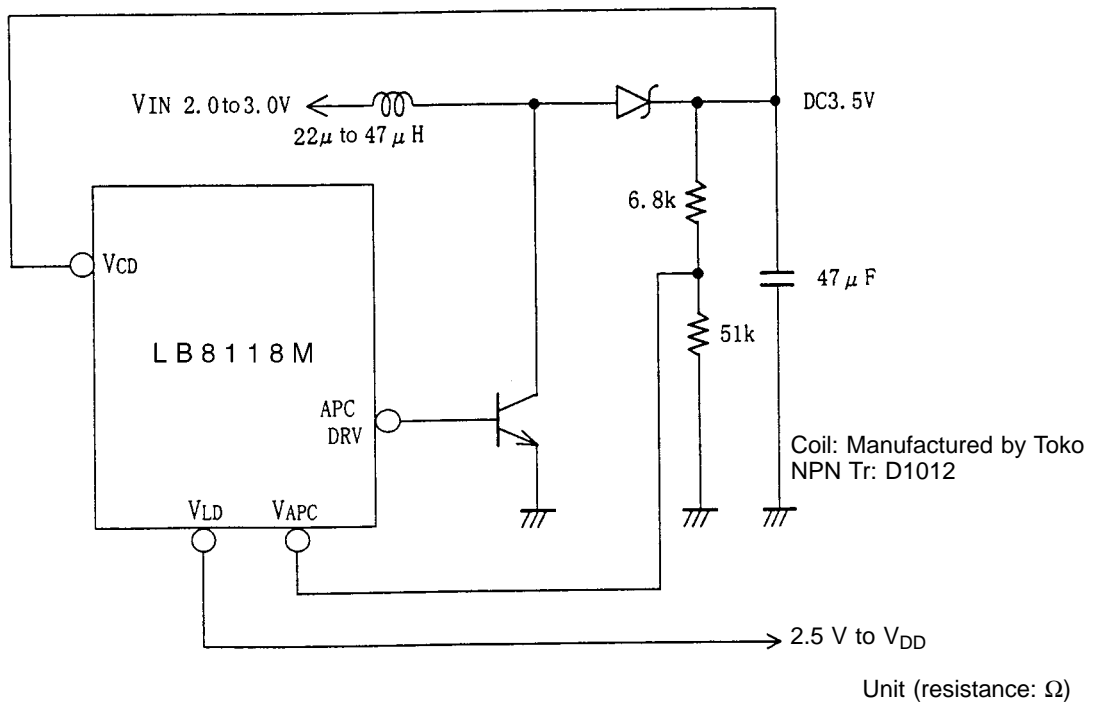

Figure 2 DC 3.5 V Sample Application (when laser power supply is V_{DD})

Supplementary Explanation

1. V_{CD} supply

The V_{CD} line is the power supply for the driver control blocks of channels 1 to 4. The VCD line can be supplied from the DSP or ASP step-up circuit by using a coil with center tap (as shown in the Block Diagram).

However, because the allowable operating range for V_{CD} is 3.6 V to 9.0 V, it is recommended that in order to reduce power dissipation, the voltage should be set to the lower range. (Even if this power supply does not affect the control performance such as the transfer gain.)

2. Sled step drive

Stepping control in this IC for the sled actuator is as described below. Normal V-type control is selected if the SLMODE pin is set high, but by setting this pin low step drive mode with low power dissipation can be selected. (This only affects channel 4.)

The step drive starting level is input from the SLREF pin (must be higher than ASPREF), and the positive side step start is determined by comparing the input voltage with IN_4 . For the negative side, the step start is determined automatically by setting the differential voltage between the SLREF and the ASPREF on the opposite side, and then comparing that voltage to IN_4 . In other words, the control characteristics become as defined by the solid line in the diagram below. (The rise on the positive and negative steps has no hysteresis.)

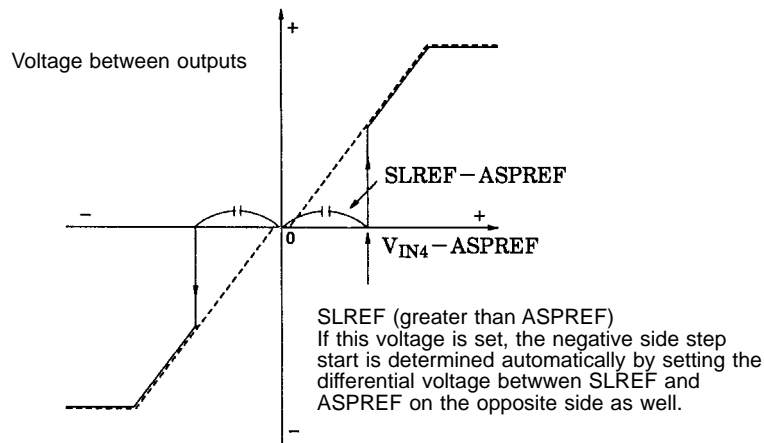

A04656

- No products described or contained herein are intended for use in surgical implants, life-support systems, aerospace equipment, nuclear power control systems, vehicles, disaster/crime-prevention equipment and the like, the failure of which may directly or indirectly cause injury, death or property loss.
- Anyone purchasing any products described or contained herein for an above-mentioned use shall:
 - ① Accept full responsibility and indemnify and defend SANYO ELECTRIC CO., LTD., its affiliates, subsidiaries and distributors and all their officers and employees, jointly and severally, against any and all claims and litigation and all damages, cost and expenses associated with such use:
 - ② Not impose any responsibility for any fault or negligence which may be cited in any such claim or litigation on SANYO ELECTRIC CO., LTD., its affiliates, subsidiaries and distributors or any of their officers and employees jointly or severally.
- Information (including circuit diagrams and circuit parameters) herein is for example only; it is not guaranteed for volume production. SANYO believes information herein is accurate and reliable, but no guarantees are made or implied regarding its use or any infringements of intellectual property rights or other rights of third parties.