

PTF 10020

125 Watts, 860–960 MHz

GOLDMOS™ Field Effect Transistor

Description

The PTF 10020 is an internally matched, 125 Watt LDMOS FET intended for large signal amplifier applications from 860 to 960 MHz. Nitride surface passivation and gold metallization ensure excellent device lifetime and reliability.

- **INTERNALLY MATCHED**
- **Performance at 960 MHz, 28 Volts**
 - Output Power = 125 Watts
 - Power Gain = 12.5 dB Typ
 - Efficiency = 55% Typ
- **Full Gold Metallization**
- **Silicon Nitride Passivated**
- **Back Side Common Source**
- **100% Lot Traceability**

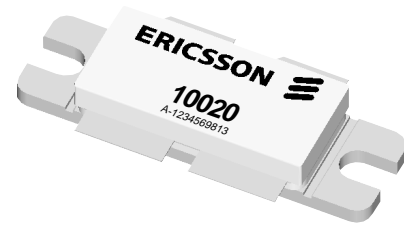
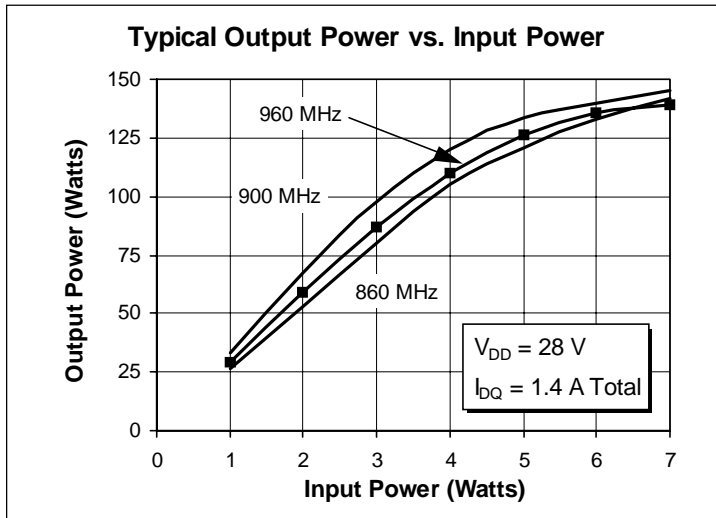

Package 20240

RF Specifications (100% Tested)

Characteristic	Symbol	Min	Typ	Max	Units
Gain ($V_{DD} = 28\text{ V}$, $P_{OUT} = 125\text{ W}$, $I_{DQ} = 1.4\text{ A Total}$, $f = 960\text{ MHz}$)	G_{ps}	11.0	12.5	—	dB
Power Output at 1 dB Compression ($V_{DD} = 28\text{ V}$, $I_{DQ} = 1.4\text{ A Total}$, $f = 960\text{ MHz}$)	P-1dB	125	130	—	Watts
Drain Efficiency ($V_{DD} = 28\text{ V}$, $P_{OUT} = 125\text{ W}$, $I_{DQ} = 1.4\text{ A Total}$, $f = 960\text{ MHz}$)	η	50	55	—	%
Load Mismatch Tolerance ($V_{DD} = 28\text{ V}$, $P_{OUT} = 125\text{ W(PEP)}$, $I_{DQ} = 1.4\text{ A Total}$, $f = 959.9, 960\text{ MHz}$ —all phase angles at frequency of test)	Ψ	—	—	10:1	—

All published data at $T_{CASE} = 25^\circ\text{C}$ unless otherwise indicated.

Electrical Characteristics (100% Tested—characteristics, conditions and limits shown per side)

Characteristic	Conditions	Symbol	Min	Typ	Max	Units
Drain-Source Breakdown Voltage	$V_{GS} = 0\text{ V}, I_D = 5\text{ mA}$	$V_{(BR)DSS}$	65	—	—	Volts
Drain-Source Leakage Current	$V_{DS} = 28\text{ V}, V_{GS} = 0\text{ V}$	I_{DSS}	—	—	1.0	mA
Gate Threshold Voltage	$V_{DS} = 10\text{ V}, I_D = 75\text{ mA}$	$V_{GS(th)}$	3.0	4.3	5.0	Volts
Forward Transconductance	$V_{DS} = 10\text{ V}, I_D = 3\text{ A}$	g_{fs}	—	2.5	—	Siemens

Maximum Ratings

Parameter	Symbol	Value	Unit
Drain-Source Voltage ⁽¹⁾	V_{DSS}	65	Vdc
Gate-Source Voltage ⁽¹⁾	V_{GS}	± 20	Vdc
Operating Junction Temperature	T_J	200	$^{\circ}\text{C}$
Total Device Dissipation at Above 25°C derate by	P_D	290 1.67	Watts $\text{W}/^{\circ}\text{C}$
Storage Temperature Range	T_{STG}	-40 to $+150$	$^{\circ}\text{C}$
Thermal Resistance ($T_{CASE} = 70^{\circ}\text{C}$)	$R_{\theta JC}$	0.6	$^{\circ}\text{C}/\text{W}$

⁽¹⁾per side

Typical Performance

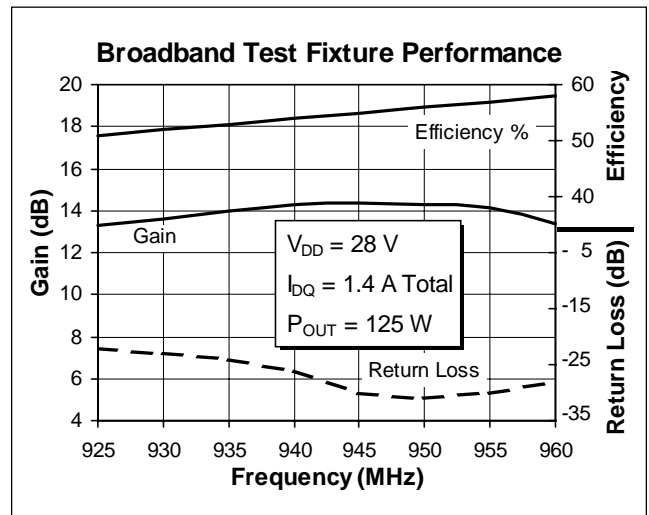
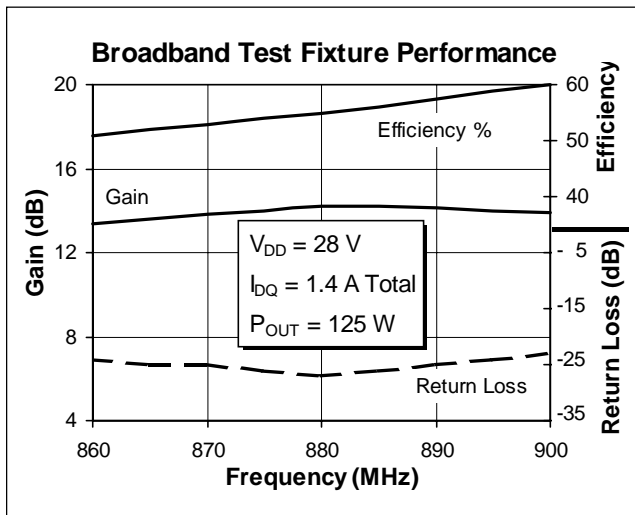

Typical Performance

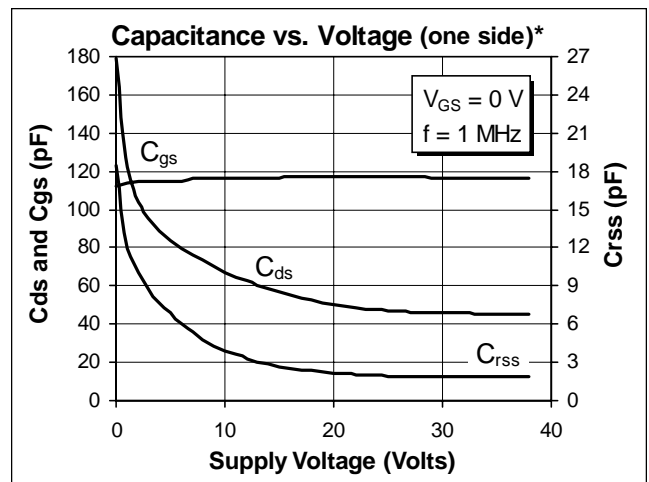
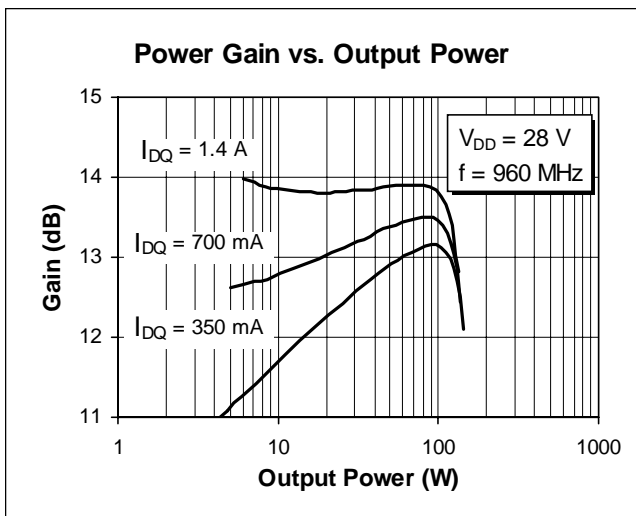
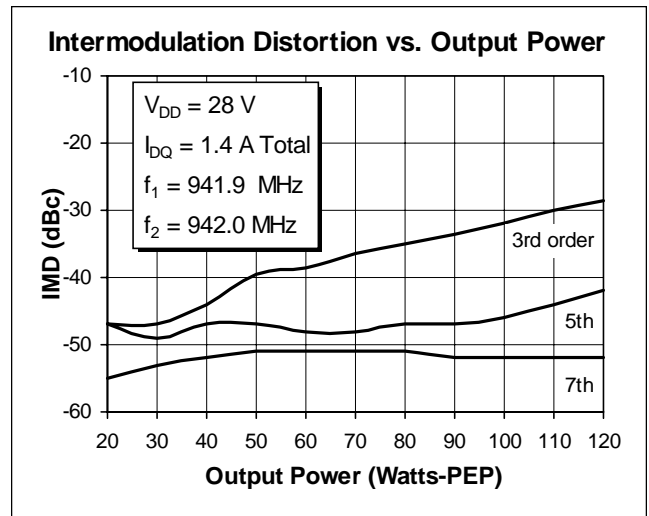
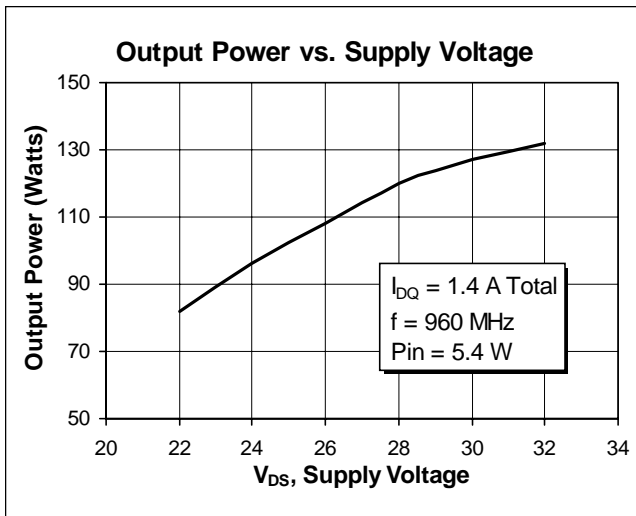
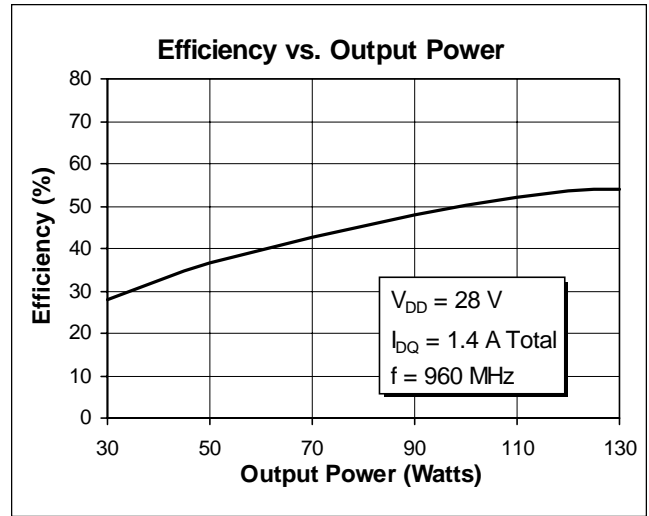
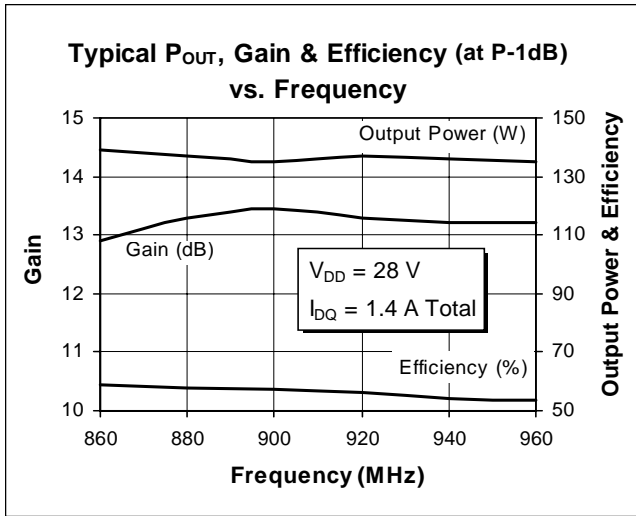

*This part is internally matched. Measurements of the finished product will not yield these figures.

Typical Performance

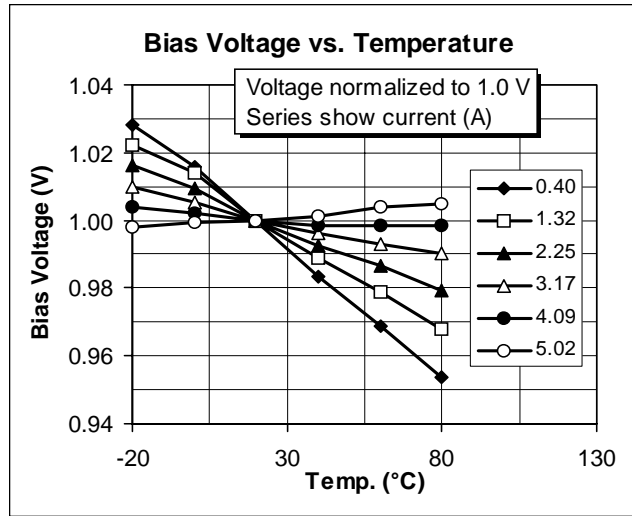

Impedance Data

($V_{DD} = 28\text{ V}$, $I_{DQ} = 1.4\text{ A}$, $P_{OUT} = 125\text{ W}$)

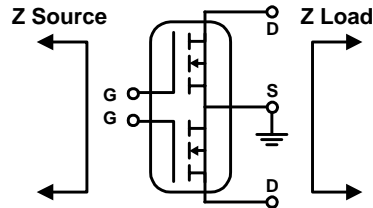

Frequency MHz	Z Source Ω		Z Load Ω	
	R	jX	R	jX
835	1.7	-8.9	2.3	-1.3
860	1.9	-9.3	2.3	-0.9
885	1.9	-9.8	2.3	-1.0
910	1.9	-11.8	2.2	-1.2
935	2.5	-12.9	2.2	-1.3
960	2.2	-12.8	2.2	-2.1
985	1.8	-11.0	2.2	-2.2

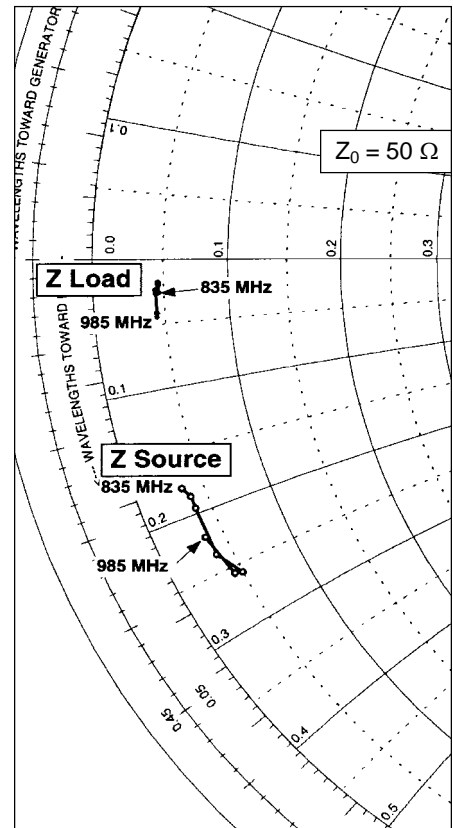

Typical Scattering Parameters (one side only)

($V_{DS} = 28\text{ V}$, $I_D = 4\text{ A}$)

f (MHz)	S11		S21		S12		S22	
	Mag	Ang	Mag	Ang	Mag	Ang	Mag	Ang
800	0.974	176	0.657	-10.6	0.002	50.9	0.97	-172
810	0.974	175.9	0.66	-11.5	0.002	49	0.971	-172.1
820	0.974	175.7	0.662	-12.7	0.002	52.9	0.971	-172.3
830	0.974	175.6	0.666	-13.6	0.002	53.4	0.972	-172.4
840	0.972	175.4	0.669	-14.8	0.002	52.6	0.972	-172.5
850	0.972	175.4	0.672	-16	0.002	54.9	0.972	-172.7
860	0.971	175.2	0.674	-16.9	0.002	56.1	0.972	-172.8
870	0.969	175	0.679	-18	0.002	52.5	0.972	-172.8
880	0.968	174.9	0.686	-19.1	0.002	53.4	0.973	-173
890	0.966	174.8	0.695	-20.2	0.002	56.2	0.975	-173.1
900	0.964	174.7	0.705	-21.4	0.002	58.1	0.977	-173.2
910	0.963	174.6	0.716	-23	0.002	55.5	0.977	-173.4
920	0.961	174.3	0.729	-24.6	0.002	57.7	0.976	-173.6
930	0.958	174.2	0.743	-26.3	0.002	57	0.977	-173.6
940	0.956	174.1	0.757	-28.2	0.002	56.7	0.978	-173.8
950	0.953	174	0.774	-30.3	0.002	58.7	0.979	-174
960	0.95	173.8	0.791	-32.7	0.002	60.2	0.979	-173.9
970	0.946	173.8	0.807	-35.4	0.002	60	0.981	-174.1
980	0.942	173.7	0.821	-38.1	0.002	59.5	0.982	-174.2
990	0.937	173.6	0.838	-41	0.002	62	0.983	-174.3
1000	0.933	173.6	0.853	-44	0.002	62.2	0.983	-174.4

Test Circuit

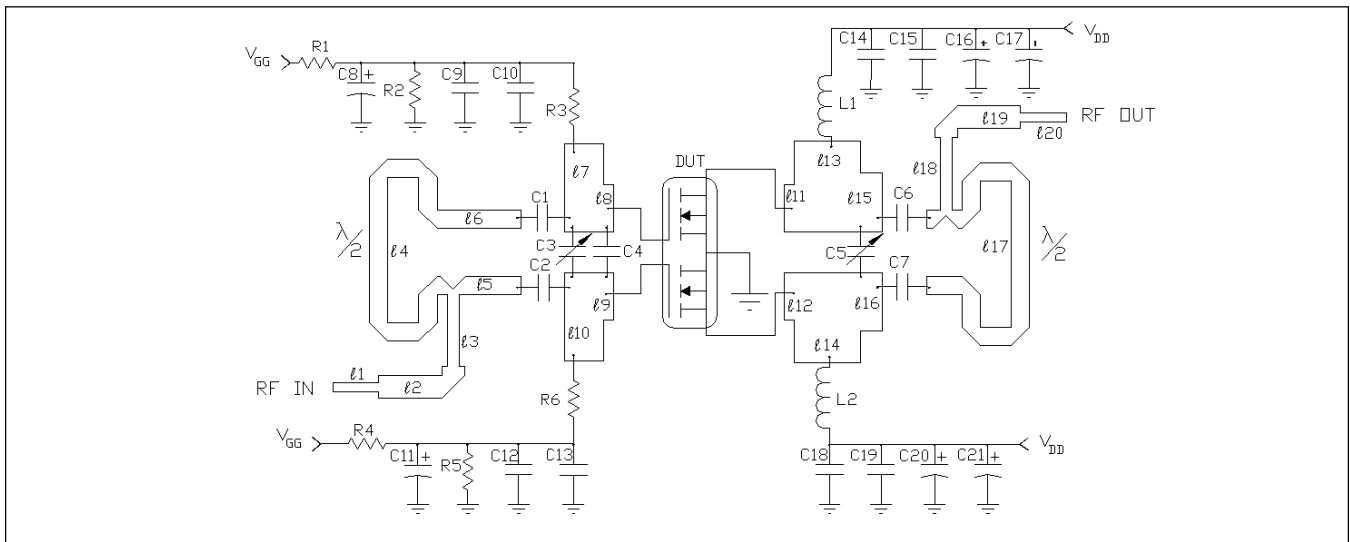

Schematic for $f = 960\text{ MHz}$

DUT	PTF 10020	$l1, l20$	50 Ω , .030 λ
C1-2	15 pF, Capacitor ATC 100 B	$l2, l19$	20 Ω , .080 λ
C3	0.35–3.5 pF, Variable Capacitor	$l3, l18$	32 Ω , .191 λ
C4	7.5 pF, Capacitor ATC 100 A	$l4, l17$	25 Ω , .500 λ
C5	1–9 pF, Variable Capacitor	$l5, l6$	25 Ω , .091 λ
C6-7, C10, C13-14, C18	33 pF, Capacitor ATC 100 B	$l7, l10$	7 Ω , .056 λ
C8, C11	10 μF , +10 V Electrolytic Capacitor	$l8, l9$	13.0 Ω , .017 λ
C9, C12, C15, C19	0.01 μF , Capacitor ATC 100 B	$l11, l12$	13.0 Ω , .017 λ
C16, C17, C20, C21	10 μF , +30 V Electrolytic Capacitor	$l13, l14$	7.0 Ω , .093 λ
L1, L2	4 Turn, #20 AWG, .120" I.D.	$l15, l16$	10.2 Ω , .030 λ
R1, R2, R4, R5	1.0 K, Ω Resistor	Circuit Board	.028" Dielectric Thickness, $\epsilon_r = 4.0$, AlliedSignal, G200, 2 oz. copper
R3, R6	5.1 K, 1/4 Ω Resistor		

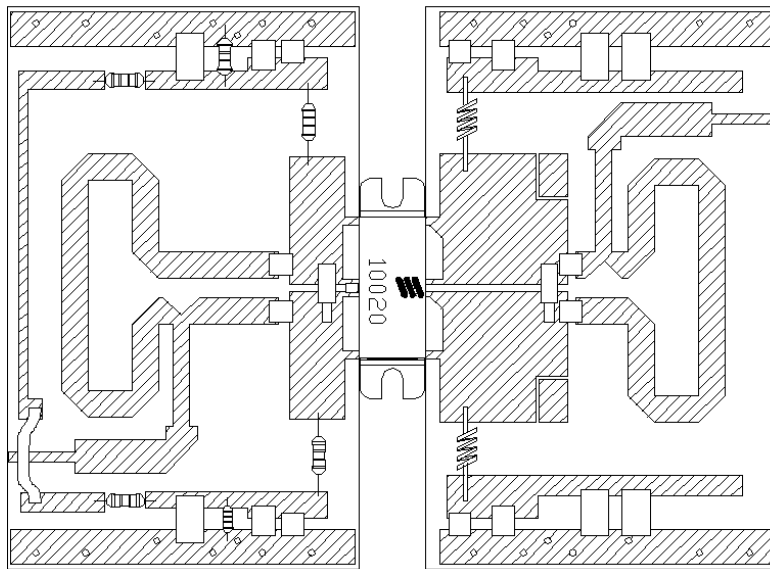

Components Layout (not to scale)

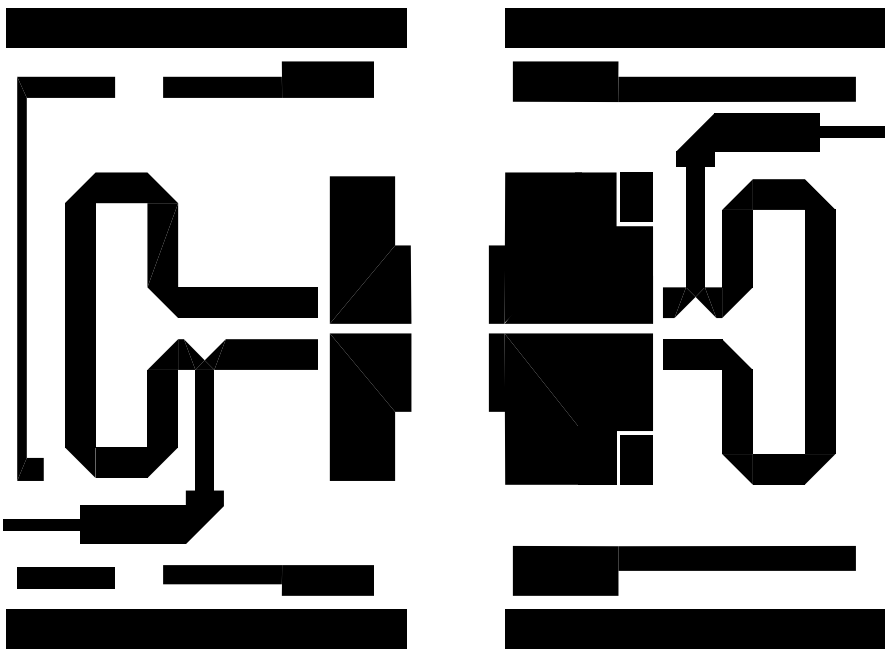

Artwork (1 inch )