

PC3H4/PC3Q64Q

Mini-falt Package AC Input Type Half Pitch Photocoupler

■ Features

1. AC input type
2. Half pitch type (lead pitch : 1.27mm)
3. Isolation voltage between input and output
(Viso: 2 500Vrms)
4. Applicable to infrared ray reflow
(230°C, for MAX. 30s)
5. High reliability
6. Taping package
PC3H4 (1ch), **PC3Q64Q** (4ch)
7. Recognized by UL, file No. E64380
Approved by VDE, No.5922UG

■ Applications

1. Programmable controllers

■ Package Specifications

Model No.	Taping specifications
PC3H4	Taping reel diameter 330mm (3 000pcs.)
PC3Q64Q	Taping reel diameter 330mm (1 000pcs.)

■ Absolute Maximum Ratings (Ta=25°C)

	Parameter	Symbol	Rating	Unit
Input	Forward current	I _F	±50	mA
	*1Peak forward current	I _{FM}	±1	A
	Power dissipation	P	70	mW
Output	Collector-emitter voltage	V _{CEO}	70	V
	Collector-emitter voltage	V _{CEO}	35	V
	Emitter-collector voltage	V _{ECO}	6	V
	Collector current	I _C	50	mA
	Collector power dissipation	P _C	150	mW
	Total power dissipation	P _{tot}	170	mW
	*2Isolation voltage	V _{iso}	2.5	kV _{rms}
	Operating temperature	T _{opr}	-30 to +100	°C
	Storage temperature	T _{stg}	-40 to +125	°C
	*3Soldering temperature	T _{sol}	260	°C

*1 Pulse width ≤ 100μs, Duty ratio : 0.001

*2 AC for 1min, 40 to 60%RH, f=60Hz

*3 For 10s

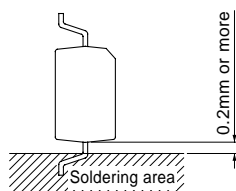

■ Outline Dimensions

(Unit : mm)

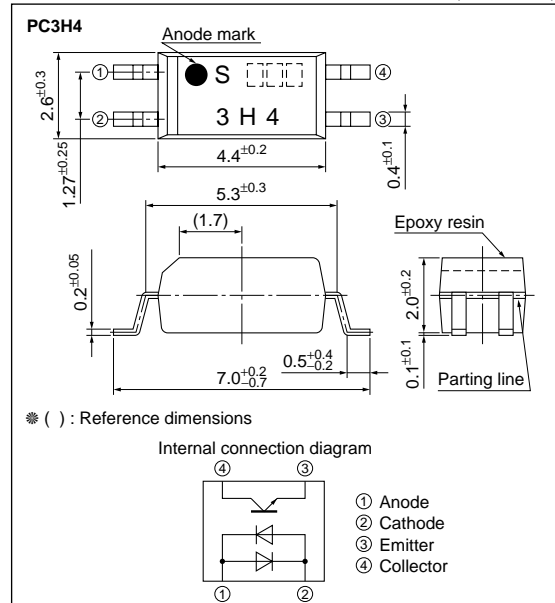

PC3Q64Q

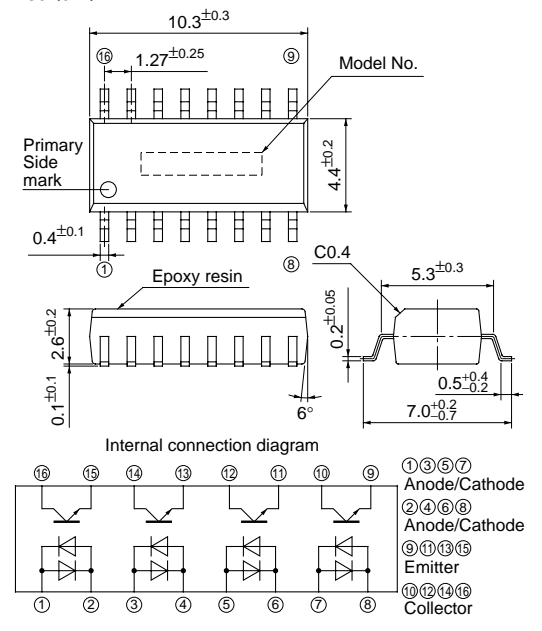

■ Electro-optical Characteristics

(T_a=25°C)

Parameter		Symbol	Conditions	MIN.	TYP.	MAX.	Unit	
Input	Forward voltage	V _F	I _F =±20mA	-	1.2	1.4	V	
	Terminal capacitance	C _t	V=0, f=1kHz	-	30	250	pF	
Output	Collector dark current	PC3H4	I _{CEO}	V _{CE} =50V, I _F =0	-	-	100	nA
		PC3Q64Q	I _{CEO}	V _{CE} =20V, I _F =0	-	-	100	nA
	Collector-emitter breakdown voltage	PC3H4	BV _{CEO}	I _C =0.1mA, I _F =0	70	-	-	V
		PC3Q64Q	BV _{CEO}	I _C =0.1mA, I _F =0	35	-	-	V
Emitter-collector breakdown voltage	BV _{ECO}	I _E =10μA, I _F =0	6	-	-	V		
Transfer characteristics	Collector current	I _C	I _F =±1mA V _{CE} =5V	0.2	-	4.0	mA	
	Collector-emitter saturation voltage	V _{CE(sat)}	I _F =±20mA I _C =1mA	-	0.1	0.2	V	
	Isolation resistance	R _{ISO}	DC500V 40 to 60%RH	5×10 ¹⁰	1×10 ¹¹	-	Ω	
	Floating capacitance	C _f	V=0, f=1MHz	-	0.6	1.0	pF	
	Response time	Rise time	t _r	V _{CE} =2V I _C =2mA	-	4	18	μs
Fall time		t _f	R _L =100Ω	-	3	18	μs	

Fig.1 Forward Current vs. Ambient Temperature

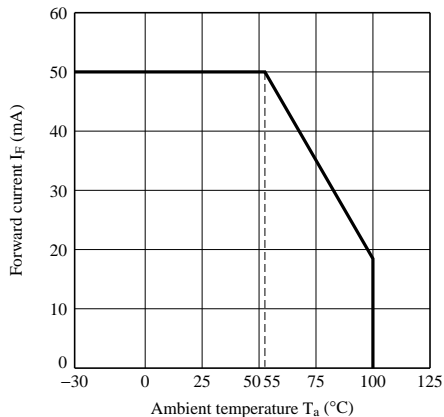

Fig.2 Diode Power Dissipation vs. Ambient Temperature

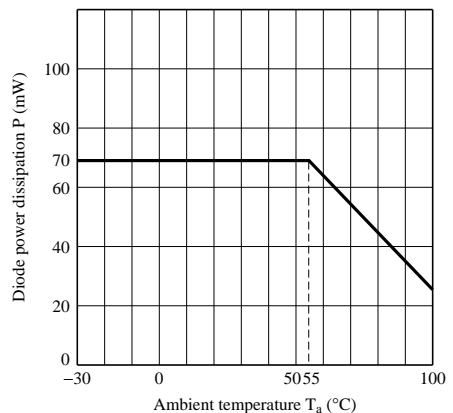

Fig.3 Collector Power Dissipation vs. Ambient Temperature

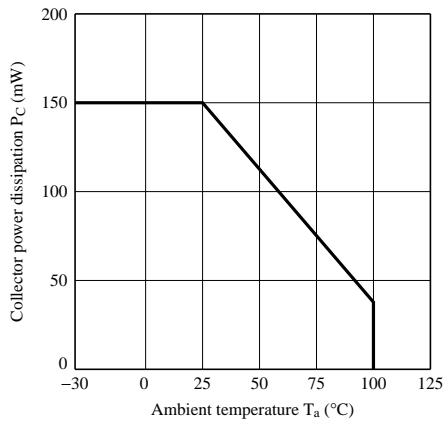

Fig.4 Total Power Dissipation vs. Ambient Temperature

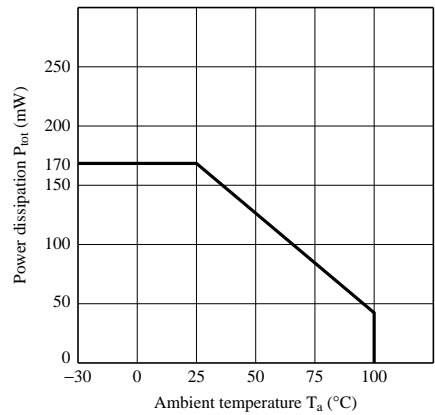

Fig.5 Peak Forward Current vs. Duty Ratio

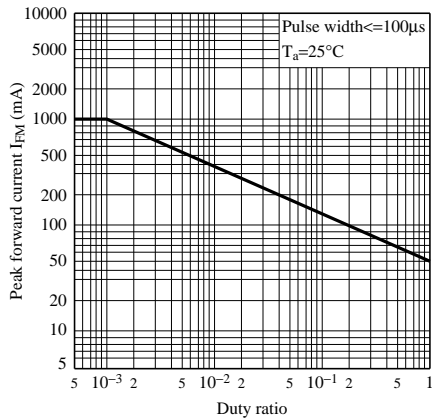

Fig.6 Forward Current vs. Forward Voltage

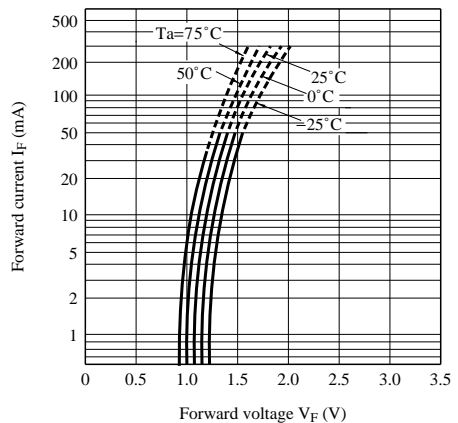

Fig.7 Current Transfer Ratio vs. Forward Current

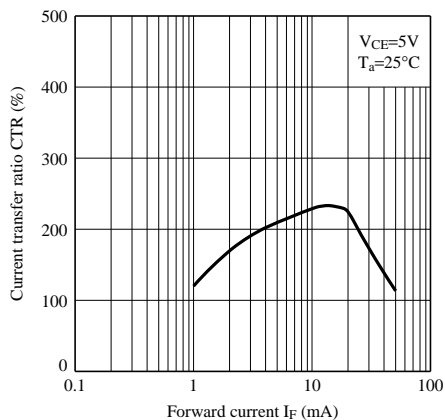

Fig.8 Collector Current vs. Collector-emitter Voltage

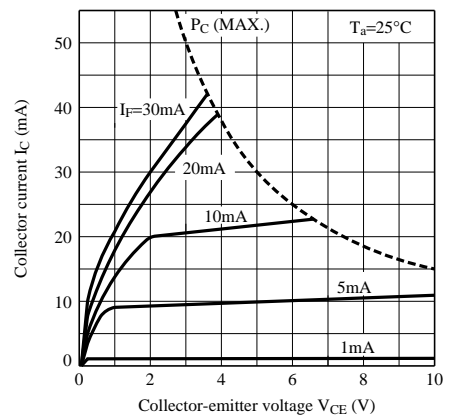

Fig.9 Relative Current Transfer Ratio vs. Ambient Temperature

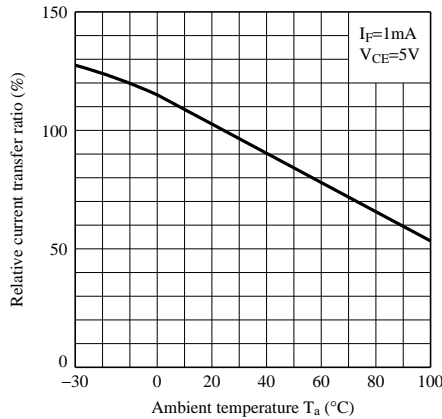

Fig.10 Collector-emitter Saturation Voltage vs. Ambient Temperature

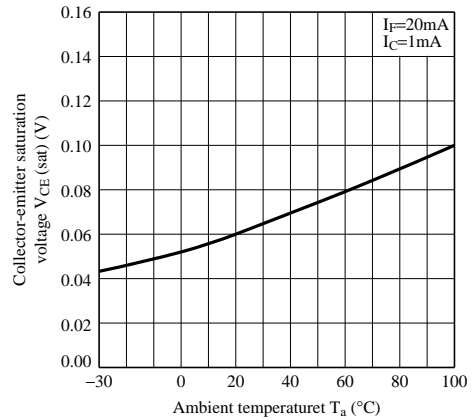

Fig.11 Collector Dark Current vs. Ambient Temperature

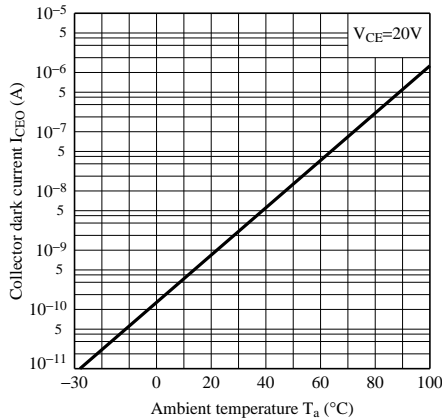

Fig.12 Response Time vs. Load Resistance

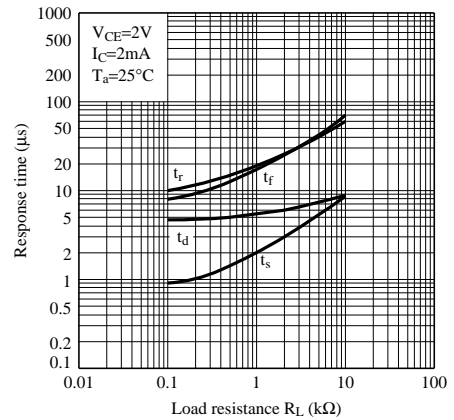

Fig.13 Test Circuit For Response Time

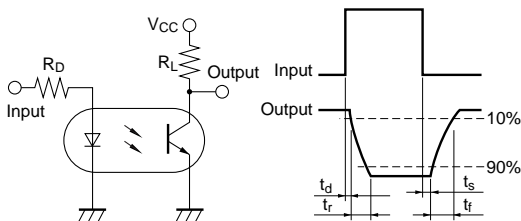

Fig.14 Collector-emitter Saturation Voltage vs. Forward Current

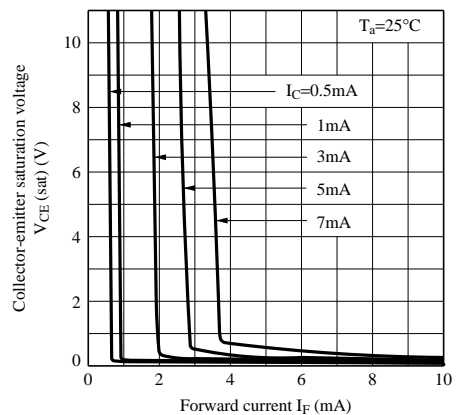
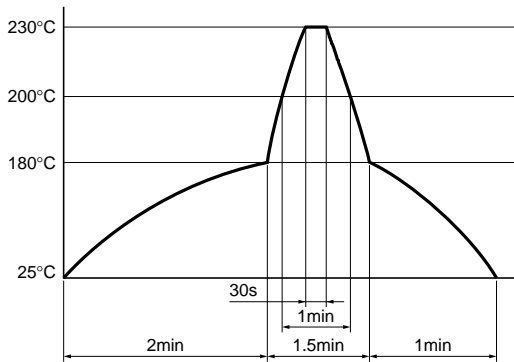

Fig.5 Reflow Soldering

Only one time soldering is recommended within the temperature profile shown below.



■ Precautions for Use

Please refer to the chapter "Precautions for Use".