

# VKA50xS

## 50 Watt Single Output Half Brick DC/DC Converter

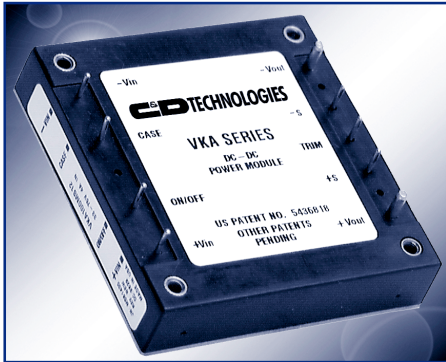

- 18-36 V & 33 - 75V Input Range
- High Efficiency: 87% Typical at 5V
- 100µS Transient Response 50-100% Load Step
- 420 kHz Fixed-Frequency Operation
- Remote Sense
- Operation to +100°C Baseplate Temperature
- Primary Remote On/Off, Choice of Pos/Neg Logic
- Adjustable Output Voltage
- Continuos Short-Circuit Protection
- Thermal Shutdown
- Case Ground Pin



The VKA50xS Series DC/DC converters present an economical and practical solution for distributed power system architectures which require high power density and efficiency while maintaining system modularity and upgradeability. With the ability to operate over a wide input voltage range of 18 to 36 and 33 to 75 volts, these modules are

ideal for use in battery backup applications common in today's telecommunication and electronic data processing applications. The output is fully isolated from the input, allowing for a variety of polarity and grounding configurations.

The VKA50xS's proprietary control circuitry responds to 50-100%

load steps in 100µSeconds to within 1% nominal Vout.

The patented fixed frequency architecture combined with surface mount technology results in a compact, efficient and reliable solution to DC/DC conversion requirements. Safety per UL1950, EN 60950 and CSA 22.2 #234

### PRODUCT SELECTION CHART

MODEL	INPUT VOLTAGE	VOUT (VDC)	IOUT (A)	EFFICIENCY	
				MIN	TYP
VKA50LS03		3.3V	10.0	80	81
VKA50LS05	24VDC	5.0V	10.0	85	86
VKA50LS12		12.0V	4.2	87	88
VKA50LS15	(18-36)	15.0V	3.3	88	89
VKA50LS24		24.0V	2.1	89	90
VKA50MS03		3.3V	10.0	81	82
VKA50MS05	48VDC	5.0V	10.0	86	87
VKA50MS12		12.0V	4.2	88	89
VKA50MS15	(33-75)	15.0V	3.3	89	90
VKA50MS24		24.0V	2.1	89	90

# SPECIFICATIONS, ALL MODELS

Specifications are at  $T_{CASE} = +40^{\circ}C$  nominal input voltage unless otherwise specified.

	PARAMETER	CONDITIONS	MIN	TYP	MAX	UNITS
<b>INPUT</b>	<b>INPUT</b>					
	Voltage Range					
	VKA50LS		18	24	36	VDC
	VKA50MS		33	48	75	VDC
	Maximum Input Current					
	VKA50LS	$V_{IN} = 16VDC$			3.7	A
	VKA50MS	$V_{IN} = 27VDC$			2.2	A
	Reflected Ripple Current	Peak - Peak		20		mA
	Input Ripple Rejection	DC to 1KHz	50	60		dB
	No Load Input Current LS/MS			50/100		mA
	Power Dissipation LS/MS					
	No Load			3.6/4.8		W
	Standby, Primary On/Off Disabled LS/MS			0.18/0.4		W
Inrush Charge	$V_{IN} = V_{INmax}$					
VKA50LS				0.520	mC	
VKA50MS				0.360	mC	
Quiescent Operating Current						
Primary On/Off Disabled			8	12	mA	
	PARAMETER	CONDITIONS	MIN	TYP	MAX	UNITS
<b>OUTPUT</b>	<b>OUTPUT</b>					
	Rated Power		0		50	W
	Set point Accuracy				1	%
	Line Regulation	High Line to Low Line		0.02	0.05	%
	Load Regulation	No Load to Rated Load		0.02	0.05	%
	Output Temperature Drift			$\pm 0.02$		$\%/^{\circ}C$
	Output Ripple, p-p	DC to 20MHz BW		1%		$V_{OUT}$ , Nom
	Output Current Limit Inception				130%	$I_{OUT}$ , Nom
	Output Short-Circuit Current (2)	test			110%	$I_{OUT}$ , Nom
	Output Overvoltage Limit			125%	130%	V
	Transient Response	50 to 100% Load Step				
	Peak Deviation	$di/dt = 1.0A/\mu Sec$		2%		$V_{OUT}$ , Nom
	Settling Time	$V_{OUT}$ 1% of Nominal Output		100		$\mu Sec$
	PARAMETER	CONDITIONS	MIN	TYP	MAX	UNITS
<b>GENERAL</b>	<b>ISOLATION</b>					
	Input to Output	Peak Test for 2 Seconds	1500			VDC
	Input to Baseplate		1500			VDC
	Output to Baseplate		500			VDC
	Resistance		10			M $\Omega$
	Capacitance			2000		pF
	Leakage Current	$V_{ISO} = 240VAC, 60Hz$		180		$\mu A$ , rms
	<b>GENERAL</b>					
	Efficiency, Line, Load, Temp. (3)					
	Switching Frequency		400	420	440	KHz
	Remote Sense Compensation				0.5	V
	Output Voltage Adjust Range	12V & higher(4)		-50% / +25%		$V_{OUT}$ , Nom
	Remote On/Off Control Inputs					
	Primary	Open Collector/Drain				
	Sink Current-Logic Low				1.0	mA
	Vlow				0.4	V
	Vhigh				Open Collector	
	Turn-on Time	Within 1% of Rated Output		10.0	12.5	mSec
	Weight				85 (3.0)	g (oz.)
	<b>TEMPERATURE</b>					
	Operation/Specification	Case Temperature	-40	+25	+100	$^{\circ}C$
	Storage	Case Temperature	-55	+25	+125	$^{\circ}C$
	Shutdown Temperature	Case Temperature	+100		+115	$^{\circ}C$
Thermal Impedance, case-ambient			7.1		$^{\circ}C/W$	
Lead Solder Temperature	10 Seconds max			+300	$^{\circ}C$	

- NOTES:** (1) See Typical Performance Curves, page 3  
 (2) Continuous Mode  
 (3) See graphs for Efficiency vs. Output Load,  $V_{IN}$ ,  $T_{CASE}$   
 (4) 3.3V Models Limited in Trim Down Range  
 (5) Consult Factory for Details

TYPICAL PERFORMANCE CURVES  
T<sub>CASE</sub> = +40°C nominal input voltage unless otherwise specified.

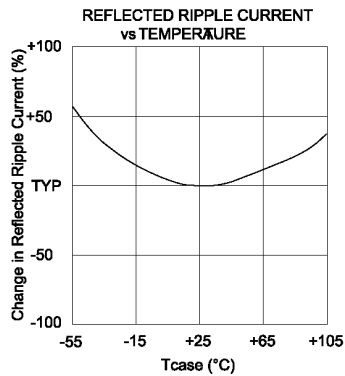
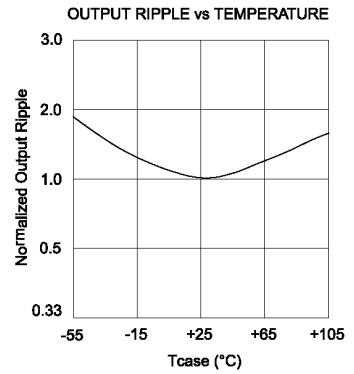
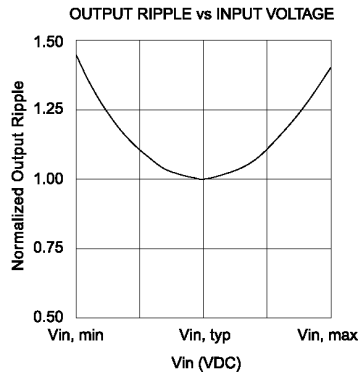
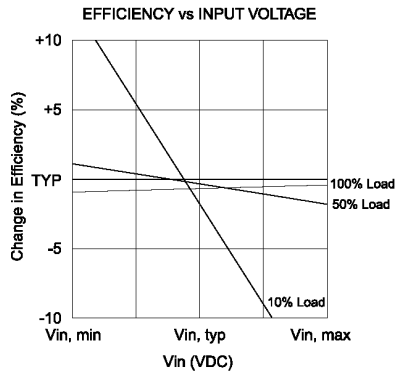
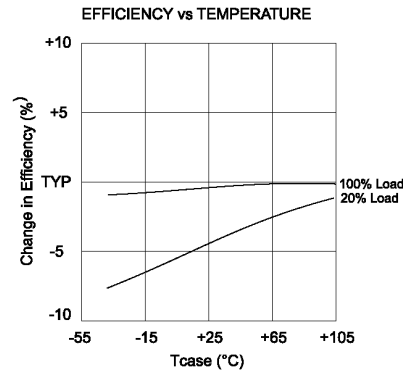
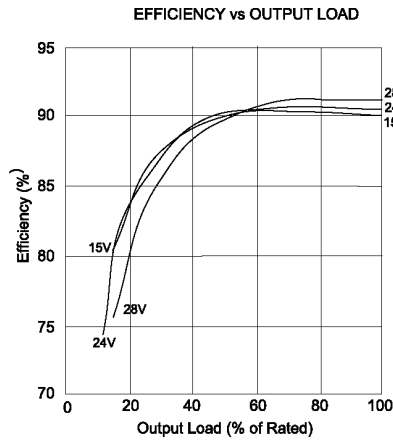
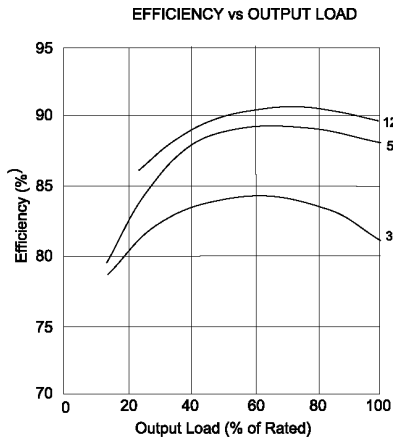

**POWER DERATING WITH NO HEATSINK**

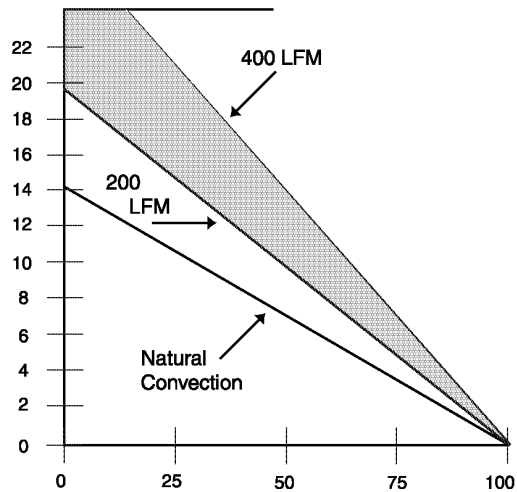

ORDERING INFORMATION

Device Family VKA50 xSzz -  
 Indicates 50 Watt Regulated Unit  
 Model Number \_\_\_\_\_  
 Selected from Table of Electrical Characteristics  
 Where:  
 x = Input Voltage (L = 24VDC; M = 48VDC)  
 zz = Output Voltage (03=3.3V, 05=5V, etc.)  
 Lead Length \_\_\_\_\_  
 0.200" - No Number  
 0.145" - (6)  
 0.110" - (8)  
 Remote On-Off Logic: \_\_\_\_\_  
 Positive - No Number  
 Negative - (1)

# MECHANICAL

## SIDE VIEW

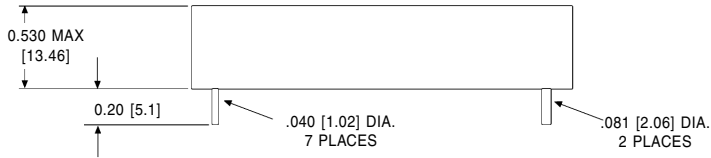

## NOTES:

All dimensions are in inches (millimeters).

PIN PLACEMENT TOLERANCE:  $\pm 0.005$ "

MECHANICAL TOLERANCE:  $\pm 0.015$ "

Marked with: specific model, ordered, date code, job code.

**MATERIAL:** Units are encapsulated in a low thermal resistance molding compound which has excellent chemical resistance and electrical properties in high humidity environments and over a wide operating temperature range. The encapsulant and outer shell of the unit have UL94V-0 ratings. Lead material is solder plated to allow ease of solderability.

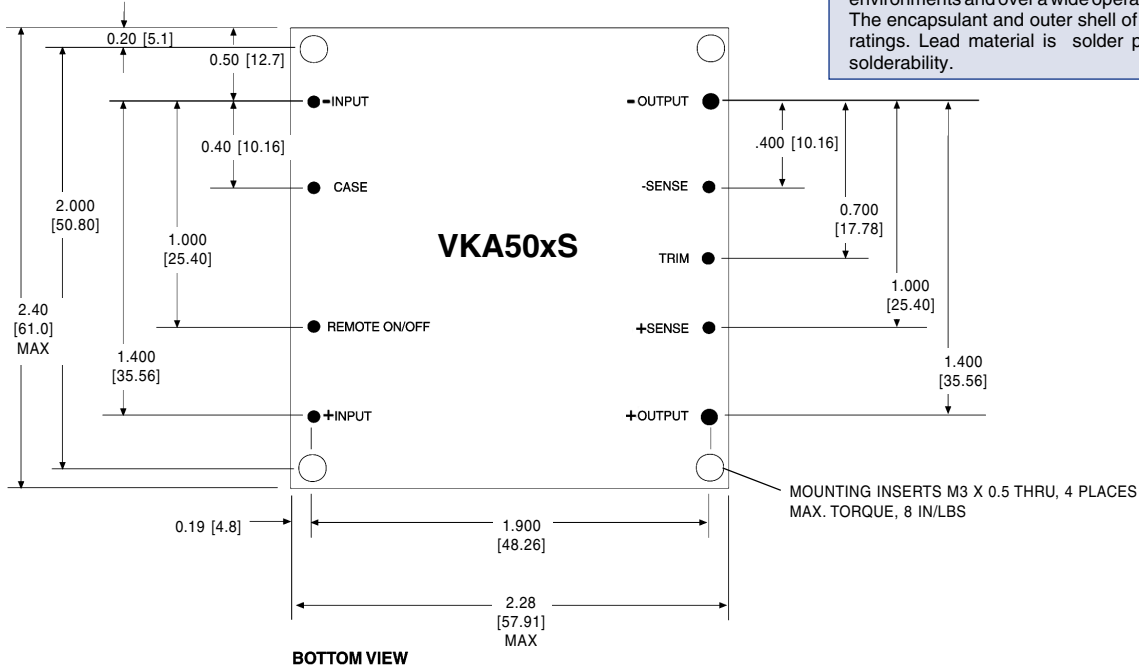

## OUTPUT ADJUST VOLTAGE

This feature allows the user to accurately adjust the module's output voltage set point to a specified level. This is achieved by connecting a resistor or potentiometer from the TRIM terminal to either the +V<sub>out</sub> terminal (for increased V<sub>out</sub>) or the -V<sub>out</sub> terminal (for decreased V<sub>out</sub>). The formulae below describe the trim resistor value to obtain a V<sub>out</sub> change of  $\Delta\%$ . V<sub>o</sub> is output voltage prior to adjustment (3.3V, 5V, 12V, 15V, or 24V).

$$\text{Radj - up} = \left( \frac{V_o(100 + \Delta\%)}{1.225\Delta\%} - \frac{(100 + 2\Delta\%)}{\Delta\%} \right) \text{ k}\Omega$$

$$\text{Radj - down} = \left( \frac{100}{\Delta\%} - 2 \right) \text{ k}\Omega$$

## OVP NOTE

Special attention should be given to the peak voltage deviation during a dynamic load step when trimming the output above the original set point to avoid tripping the overvoltage protection circuit. Should an OVP condition occur, the converter will go into a latch condition and must be externally reset before it will return to normal operation.

**C&D Technologies (Power Electronics) Ltd.**  
Shannon, Co. Clare, Ireland  
Tel: +353.61.474.133 Fax: +353.61.474.141

**Power Electronics Division, United States**  
3400 E Britannia Drive, Tucson, Arizona 85706  
Tel: 800.547.2537 Fax: 520.770.9369

**C&D Technologies, (NCL)**  
Milton Keynes MK14 5BU UK  
Tel: +44 (0)1908 615232 Fax: +44 (0)1908 617545

Any data, prices, descriptions or specifications presented herein are subject to revision by C&D Technologies, Inc. without notice. While such information is believed to be accurate as indicated herein, C&D Technologies, Inc. makes no warranty and hereby disclaims all warranties, express or implied, with regard to the accuracy or completeness of such information. Further, because the product(s) featured herein may be used under conditions beyond its control, C&D Technologies, Inc. hereby disclaims all warranties, either express or implied, concerning the fitness or suitability of such product(s) for any particular use or in any specific application or arising from any course of dealing or usage of trade. The user is solely responsible for determining the suitability of the product(s) featured herein for user's intended purpose and in user's specific application. C&D Technologies, Inc. does not warrant or recommend that any of its products be used in any life support or aviation or aerospace applications.