

Agilent HCMS-235x

CMOS Extended Temperature Range

5 x 7 Alphanumeric Display

Data Sheet



Description

This sunlight viewable 5 x 7 LED four-character display is contained in 12 pin dual-in-line packages designed for displaying alphanumeric information. The display is designed with on-board CMOS integrated circuits. Two CMOS

ICs form an on-board 28-bit serial-in/parallel-out shift register with constant current output LED row drivers. Decoded column data is clocked into the on-board shift register for each refresh cycle. Full character display is achieved with external column strobing.

Features

- **On-Board low power CMOS IC**
Integrated shift register with constant current LED drivers
- **Wide operating temperature range**
-55°C to +100°C
- **Compact glass ceramic 4 character package**
Series X-Y stackable
- **Sunlight viewable**
- **5 x 7 LED matrix displays full ASCII set**
- **Character height of 5.0 mm (0.20 inch)**
- **Wide viewing angle**
X Axis = $\pm 50^\circ$
Y Axis = $\pm 65^\circ$
- **Usable in night vision lighting applications**

Typical Applications

- Avionics
- Communication systems
- Fire control systems
- Radar systems



Package Dimensions

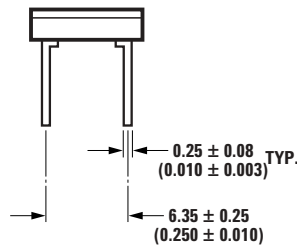
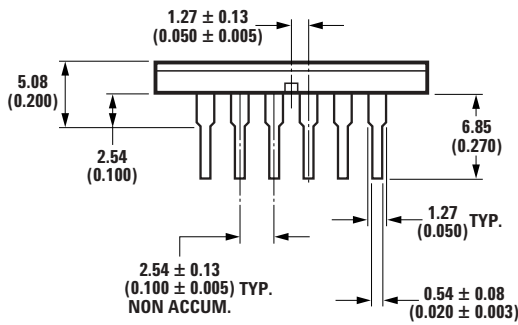
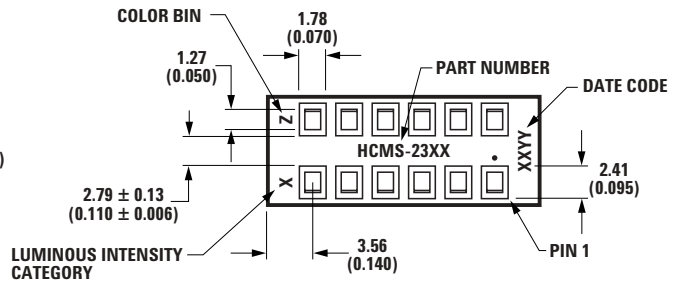
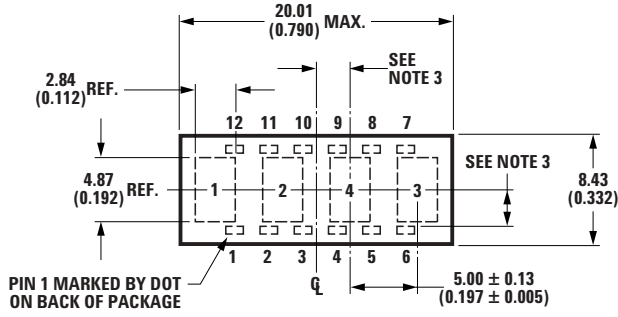

PIN	FUNCTION	PIN	FUNCTION
1	COLUMN 1	7	DATA OUT
2	COLUMN 2	8	V _B
3	COLUMN 3	9	V _{DD}
4	COLUMN 4	10	CLOCK
5	COLUMN 5	11	GROUND
6	INT. CONNECT*	12	DATA IN

* DO NOT CONNECT OR USE

NOTES:

1. DIMENSIONS IN MILLIMETERS (INCHES).
2. UNLESS OTHERWISE SPECIFIED, THE TOLERANCE ON ALL DIMENSIONS IS ± 0.38 mm (± 0.015).
3. CHARACTERS ARE CENTERED WITH RESPECT TO LEADS WITHIN ± 0.13 mm (± 0.005).
4. LEAD MATERIAL IS COPPER ALLOY, SOLDER DIPPED.

Absolute Maximum Ratings

Parameter	Value
Supply Voltage V _{DD} to Ground	-0.3 V to 7.0 V ^[1]
Data Input, Data Output, V _B	-0.3 V to V _{DD}
Column Input Voltage, V _{COL}	-0.3 V to V _{DD}
Free Air Operating Temperature Range, T _A	-55°C to +100°C
Storage Temperature Range, T _s	-55°C to +100°C
Maximum Allowable Package Power Dissipation, P _D ^[2,3] at T _A = 71°C	1.31 Watts
Through-the-Wave Solder Temperature 1.59 mm (0.063") Below Body	250°C for 3 secs. max.
ESD Protection @ 1.5 kΩ, 100 pF	V _Z = 4 kV

Notes:

1. Maximum duration 2 seconds.
2. Maximum allowable power dissipation is derived from V_{DD} = 5.25 V, V_B = 2.4 V, V_{COL} = 3.5 V, 20 LEDs ON per character, 20% DF.
3. HCMS-2353 derate above 71°C at 23 mW/°C, Rθ_{J-A} = 45°C/W.
Derating based on RθPC-A = 35°C/W per display for printed circuit board assembly.

**Recommended Operating Conditions
Over Operating Range (–55°C to + 100°C)**

Parameter	Symbol	Min.	Typ.	Max	Units
Supply Voltage	V _{DD}	4.75	5.00	5.25	V
Data Out Current, Low State	I _{OL}			1.6	mA
Data Out Current, High State	I _{OH}			–0.5	mA
Column Input Voltage	V _{COL}	2.75	3.0	3.5	V
Setup Time	t _{SETUP}	10			ns
Hold Time	t _{HOLD}	25			ns
Clock Pulse Width High	t _{WH(CLOCK)}	50			ns
Clock Pulse Width Low	t _{WL(CLOCK)}	50			ns
Clock High to Low Transition	t _{THL}			200	ns
Clock Frequency	f _{CLOCK}			5	MHz

**Electrical Characteristics
Over Operating Range (–55°C to + 100°C)**

Parameter	Symbol	Test Conditions	Min	Typ.*	Max	Units
Supply Current, Dynamic ^[1]	I _{DDD}	f _{CLOCK} = 5 MHz		6.2	7.8	mA
Supply Current, Static ^[2]	I _{DDSoFF}	V _B = 0.4 V, Data and Clock = 0.4 V		1.8	26	mA
	I _{DDSoN}	V _B = 2.4 V, Data and Clock = 0.4 V		2.2	6.0	mA
Column Input Current	I _{COL}	V _B = 0.4 V			10	μA
		V _B = 2.4 V		500	650	mA
Input Logic High Data, V _B , Clock	V _{IH}	V _{DD} = 4.75 V	2.0			V
Input Logic Low Data, V _B , Clock	V _{IL}	V _{DD} = 5.25 V			0.8	V
Input Current Data Clock, V _B	I _I	V _{DD} = 5.25 V				
		V _I ^[3] = 2.4 V (Logic High) or	–46	–60	–103	μA
		V _I ^[3] = 0.4 V (Logic Low)	–92	–120	–206	
Data Out Voltage	V _{OH}	V _{DD} = 4.75 V I _{OH} = –0.5 mA I _{COL} = 0 mA	2.4	4.2		V
	V _{OL}	V _{DD} = 5.25 V I _{OL} = 1.6 mA I _{COL} = 0 mA		0.2	0.4	V
Power Dissipation Per Package ^[4]	P _D	V _{DD} = 5.0 V V _{COL} = 5.0 V 17.5% DF V _B = 2.4 V 15 LEDs ON per Character		668		mW
Thermal Resistance IC Junction-to-Pin ^[5]	R _{θJ-PIN}			10		°C/W
Leak Rate					5x10 ^{–8}	cc/sec

*All typical values specified at V_{DD} = 5.0 V and T_A = 25°C.

Notes:

- I_{DD} Dynamic is the IC current while clocking column data through the on-board shift register at a clock frequency of 5 MHz, the display is not illuminated.
- I_{DD} Static is the IC current after column data is loaded and not being clocked through the on-board shift register.
- V_I represents the input voltage to an input pin.
- Four characters are illuminated with a typical ASCII character composed of 15 dots per character.
- IC junction temperature T_J (IC) = (P_D)(R_{θJ-PIN} + R_{θPC-A}) + T_A.

Optical Characteristics at T_A = 25°C
High Performance Green HCMS-2353

Description	Symbol	Test Condition	Min.	Typ.*	Max.	Units
Peak Luminous Intensity per LED ^[6] (Character Average)	I _{VPEAK}	V _{DD} = 5.0 V V _{COL} = 5.0 V V _B = 2.4 V T _i = 25°C ^[7]	2400	3000		μcd
Dominant Wavelength ^[8,9]	λ _d			574		nm
Peak Wavelength	λ _{PEAK}			568		nm

Yellow HCMS-2351

Description	Symbol	Test Condition	Min	Typ.*	Max.	Units
Peak Luminous Intensity per LED ^[6] (Character Average)	I _{VPEAK}	V _{DD} = 5.0V V _{COL} = 5.0 V V _B = 2.4V T _i = 25°C ^[7]	1600	2400		μcd
Dominant Wavelength ^[8,9]	λ _d			585		nm
Peak Wavelength	λ _{PEAK}			583		nm

*All typical values specified at V_{DD} = 5.0 V and T_A = 25°C unless otherwise noted.

Notes:

- These LED displays are categorized for luminous intensity, with the intensity category designated by a letter code on the back of the package.
- T_i refers to the initial case temperature of the display immediately prior to the light measurement.
- Dominant wavelength, λ_d, is derived from the CIE Chromaticity Diagram, and represents the single wavelength which defines the color of the device.
- Categorized for color with the color category designated by a number on the back of the package.

Switching Characteristics

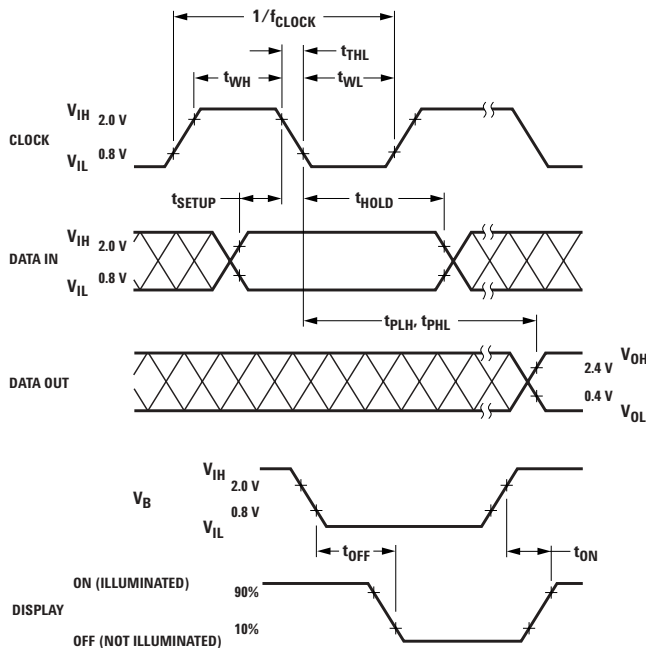

Parameter	Condition	Typ.	Max.	Units
f _{clock} CLOCK Rate		5		MHz
t _{PLH} , t _{PHL} Propagation Delay CLOCK to DATA OUT	C _L = 15 pF R _L = 2.4 kΩ		105	ns
t _{OFF} V _B (0.4 V) to Display OFF		4	5	μs
t _{ON} V _B (2.4 V) to Display ON		1	2	

Electrical Description

The display contains four 5 x 7 LED dot matrix characters and two CMOS integrated circuits, as shown in Figure 1. The two CMOS integrated circuits form an on-board 28 bit serial-in/parallel-out shift register that will accept standard TTL logic levels. The Data Input, pin 12, is connected to bit position 1 and the Data Output, pin 7, is connected to bit position 28. The shift register outputs control constant current sinking LED row drivers. A logic 1 stored in the shift register enables the corresponding LED row driver and a logic 0 stored in the shift register disables the corresponding LED row driver.

The electrical configuration of these CMOS IC alphanumeric displays allows for an effective interface to a display controller circuit that supplies decoded character information. The row data for a given column (one 7 bit byte per character) is loaded (bit serial) into the on-board 28 bit shift register with high to low transitions of the Clock input. To load decoded character information into the display, column data for character 4 is loaded first and the column data for character 1 is loaded last in the following manner. The 7 data bits for column 1, character 4, are loaded into the on-board shift register. Next, the 7 data bits for column 1, character 3, are loaded into the shift register,

shifting the character 4 data over one character position. This process is repeated for the other two characters until all 28 bits of column data (four 7 bit bytes of character column data) are loaded into the on-board shift register. Then the column 1 input, V_{COL} pin 1, is energized to illuminate column 1 in all four characters. This process is repeated for columns 2, 3, 4 and 5. All V_{COL} inputs should be at logic low to insure the display is off when loading data. The display will be blanked when the blanking input V_B , pin 8, is at logic low regardless of the outputs of the shift register or whether one of the V_{COL} inputs is energized. Refer to Application Note 1016 for drive circuit information.

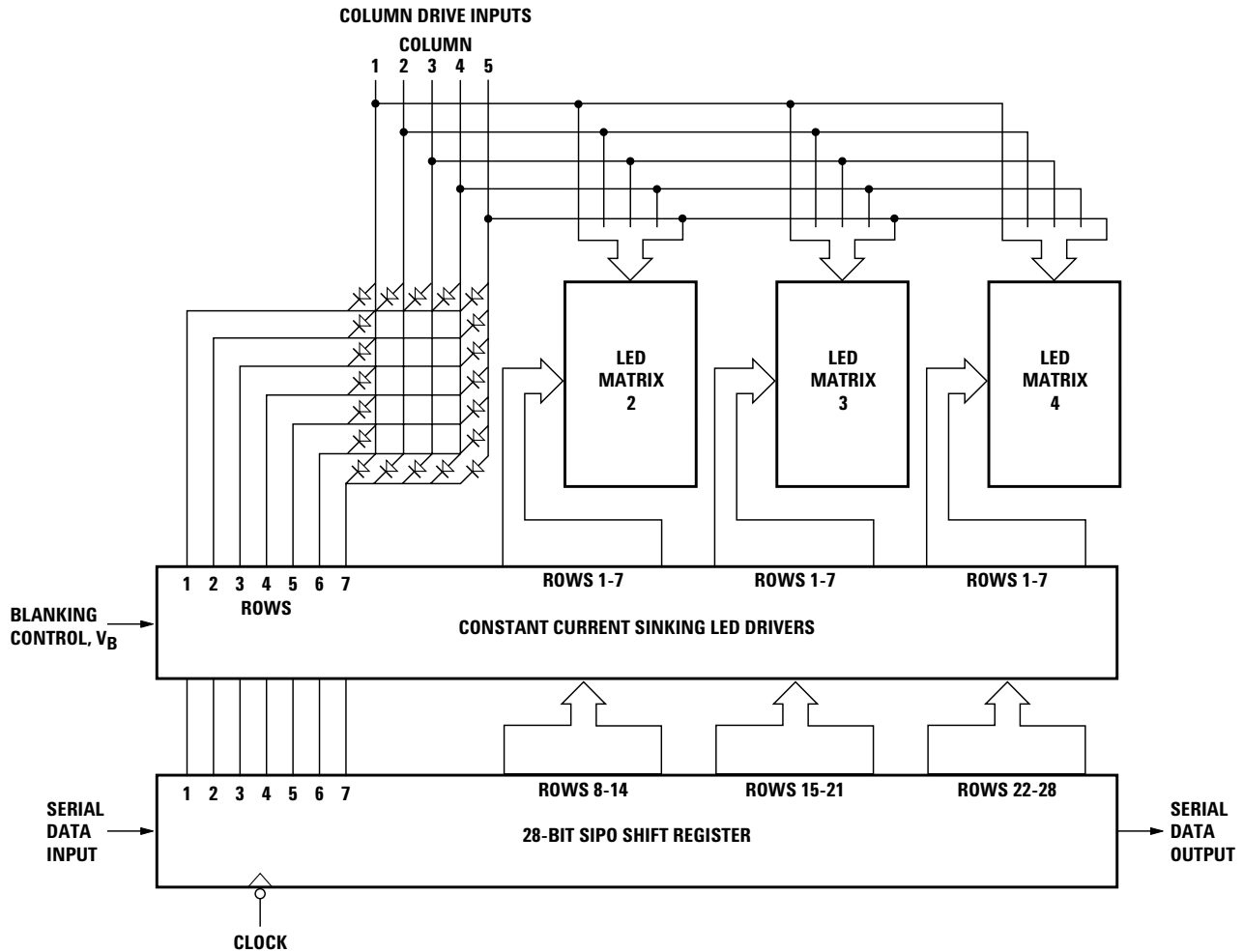

Figure 1. Display block diagram.

ESD Susceptibility

The display has an ESD susceptibility ratings of CLASS 3 of MIL-STD-883E, HBM. It is recommended that normal CMOS handling precautions be observed with these devices.

Soldering and Post Solder Cleaning

These displays may be soldered with a standard wave solder process using either an RMA flux and solvent cleaning or an OA flux and aqueous cleaning. For optimum soldering, the solder wave temperature should be 245 °C and the dwell time for any display lead passing through the wave should be 1.5 to 2 seconds. For more detailed information, refer to Application Note 1027, *Soldering LED Components*.

Contrast Enhancement

When used with the proper contrast enhancement filters, the display is readable in sunlight.

Refer to Application Note 1029, *Luminous Contrast and Sunlight Readability of the HDSP-235X Series Alpha-numeric Displays for Sunlight Viewable Applications*, for information on contrast enhancement for sun-light and daylight ambient. Refer to Application Note 1015, *Contrast Enhancement Techniques for LED Displays*, for information on contrast enhancement in moderate ambients.

Night Vision Lighting

When used with the proper NVG/DV filters, HCMS-235x display may be used in night vision lighting applications. For a list of NVG/DV filters and a discussion on night vision lighting technology, refer to Application Note 1030, *LED Displays and Indicators and Night Vision Imaging System Lighting*.

Controller Circuits, Power Calculations, and Display Dimming

Refer to Application Note 1016, *Using the HDSP-2000 Alphanumeric Display Family*, for information on controller circuits to drive these displays, how to do power calculations, and a technique for display dimming.

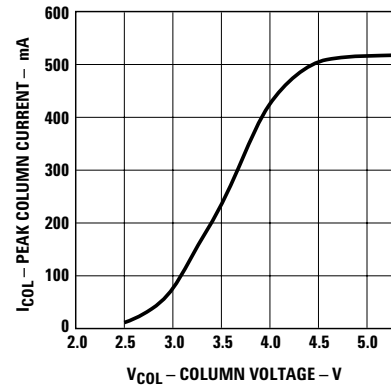

Figure 2. Peak column current vs. column voltage at T_A = 25°C.

www.agilent.com/semiconductors

For product information and a complete list of distributors, please go to our web site.

Data subject to change.

Copyright © 2004 Agilent Technologies, Inc.

August 13, 2004

5989-1320EN



Agilent Technologies